

CRESSI

SINCE 1946

SCUBA DIVING

FREEDIVING

SNORKELING



SWIMMING

SPEARFISHING

international

BUYER'S GUIDE 2019

MADE IN ITALY

 CRESSI <i>Atelier</i> offline product	7
 CRESSI <i>Specialized</i> Retailer-Product	8
 CRESSI dive center	10
WATCHES	11
COMPUTERS	20
REGULATORS	33
B.C.D.'S	48
DIVE SUITS	64
FINS	95
SETS	124
MASKS	132
SNORKELING MASKS	150
COMBOS	161
SNORKELS	172
SWIM	185
BAGS	203
ACCESSORIES	213
TORCHES AND TANKS	214
KNIVES	216
SPEARGUNS	229
SPEARFISHING WETSUITS	250
CRESSI CONCEPT STORE	257
AMBASSADOR	262



FIND OUT OUR CRESSI
BY THE SEA PRODUCTS RANGE!
ASK YOUR AREA MANAGER FOR
MORE INFORMATION ABOUT
THE NEW 2019 CATALOGUE



**CRESSI SUB S.P.A. - HEAD QUARTERS**

VIA GELASIO ADAMOLI, 501
16165 GENOVA - ITALY

**CRESSI SUB
FRANCE**

ROUTE
DE SAINT-LAURENT
06610
LA GAUDE
FRANCE

**CRESSI-SUB
ESPAÑA, S.A.**

C/ CASTELLASSA, 24
NAVE 3 POLÍGONO
INDUSTRIAL
CAN PETIT
08227
TERRASSA
(BARCELONA)

**CRESSI-SUB
USA, INC**

3 ROSOL LANE
SADDLE BROOK
NJ
07063

**CRESSI MEXICO
CRESSIWATER
S.A.P.I DE C.V.**

CENTRAL DE ABASTOS
CANCÚN
CARRETERA CANCÚN
AEROPUERTO KM 17
77565 CANCÚN
Q.R., MÉXICO
SUPERMANZANA
N. 301, MANZANA 4
LOTE 5
UNIDAD NO 518-A

**CRESSI CHINA
WATERSPORTS
PRODUCTS CO. LTD.**

NO.8 NANHE ROAD
KUNSHAN CITY
JIANGSU
PROVINCE
CHINA

**CRESSI THAILAND
CRESSI SOUTH
EAST ASIA LTD.**

23RD FLOOR TWO
PACIFIC PLACE
BUILDING
142 SUKHUMVIT
ROAD KLONGTOEY
BANGKOK
10110
THAILAND

HISTORY 1930'S-1940'S

1938 Brothers Egidio and Nanni Cressi start to handcraft the first masks and spearfishing guns. These are the origins of Cressi, the oldest scuba diving equipment company worldwide.

1943 The first Cressi mask, The Sirena, was hand crafted in 1943. It remained in the catalogue, with various updates, for more than 30 years.

1946 The Cressi company is officially founded in Genova, Italy. By the late 1940s, Cressi had in its catalogue a complete range of spearguns of varying lengths and strengths. The line included about a dozen separate models.

1947 Aro AR47 - In 1947 the first oxygen rebreather was produced; it was already highly advanced and fitted with sophisticated technical solutions, like the condensation receptacle.

1948 A wide range of masks were available for all needs: spearfishing, snorkeling and scuba ping.

HISTORY 1950'S

1950 Cressi becomes an international company, and it starts to export its products all over the world.

1952 Pinocchio Mask - Cressi invented and produced the first mask in the world with a dedicated nose pocket, which makes equalization possible. It is a major innovation in the early '50s. It is the most famous and most sold mask in the world's history, and it is still included in the catalogue.

1953 Rondine Fins - Also in the field of fins, Cressi invented the model that has inspired all other manufacturers. Some of the revolutionary features of the Rondine fins were: the blade tilted from the foot, the strong side reinforcements, the upper opening for toes, and the closed foot pocket.

1954 Aer 54 speargun - In 1951 the Aer 51 was presented. It was a speargun using the gas contained in small, economical CO2 tanks for propulsion. In 1954 the updated version called Air 54 was introduced.

1957 Cressi athlete Mario Catalani wins the spearfishing world title in Yugoslavia. It is the first spearfishing world tournament in history.

Aro Ar57b - In 1957, the new oxygen rebreather was presented and immediately adopted by the Italian armed forces, by fire-fighters and by pe schools. It was the simplest, most reliable and safe oxygen device on the market, and is still being used by some armed forces.

1959 Cressi athlete Terry Lentz wins the spearfishing world title in Malta.

HISTORY 1960'S

1960 At the end of the '50s the Cressi range of Rondine fins was expanded with the floating model, the open-heel model and in 1960, with the futuristic Super Rondine, which had special flaps that automatically opened to eliminate the negative zone of the fin and to increase thrust performance.

1960 Cressi athlete Bruno de Otero Hermann wins the spearfishing world title in Italy.

1963 Cressi athlete Bruno de Otero Hermann wins the spearfishing world title in Brasil.

1965 Pneumatic spearguns - In the mid '60s, the Mach 1.1 pneumatic speargun was presented, followed by the 0.9 model and by the Aer Saetta, a range that stayed in the catalogue for many years, thanks to their excellent craftsmanship and excellent performances. Polaris 4 regulator - The Polaris 4, legendary two-stage regulator entered production, with the piston first stage and the housing of the second stage in chromed brass. Its extraordinary reliability and minimum maintenance needs made it the favorite of pers all over the world. In the 1960s, Cressi opened one of the first workshops that specialized in producing optical masks: Pinocchio and Semi-Pinocchio, followed over the years by various other models. Thanks to Cressi, even people with visual defects could now get full enjoyment of the underwater universe.

1967 The Pinocchio Vi. Erre (Reduced Volume) introduced a new kind of accentuated V mask, which drastically reduced the inner volume of the mask, without compromising visibility.

HISTORY 1970'S

1970 Equi-vest - In 1970, Cressi was the first manufacturer in the world to produce Equi-Vest, a futuristic jacket that became one with the scuba tank, supplied by a hose that drew air directly from the first stage.

This was the first incarnation of the modern BC. Polaris 5S - Cressi designed the Polaris 5, its first balanced two-stage regulator, conceived to provide excellent performance to scuba pers to assist in their ping records and for coral pers. Rondine L long fins - The world leader of molding rubber fins, Cressi developed the Rondine L long fins, which enabled Jacques Mayol to go onto achieve his astonishing free ping records.

1974 Control instruments - A substantial series of control instruments made it possible for pers to pe in complete safety.

1979 Fins range - Alongside the various rubber fin models, a futuristic model was presented with a reinforced nylon blade, called the Rondine Gara, a fin that thirty years down the line is still going strong, and has been adopted by world class free-pers and spearfishermen the world over.

HISTORY 1980'S

1980 Cressi's first subsidiary is born in Nice, France.

1983 Galaxie regulators - The Cressi range of regulators was renewed with the introduction of the Galaxie range, three models suitable to cover every market segment, from beginners to professionals. The spearhead F1 model was fitted with an injection system that brought performance levels up to their maximum.

1987 Cressi athlete Renzo Mazzarri wins the spearfishing world title in Turkey.

1988 Equipe Jacket - The BC took on the form of a jacket and Cressi immediately presented a refined, strong model that was updated year after year. Rondine Gara fins - The nylon blade of the now legendary Rondine Gara was replaced by a polypropylene blade; this material provided a far superior elastic response. The already fantastic performance was increased even further. Cressi produced a complete range of Arbalete spearguns to join the pneumatic guns, called the Apache, which very soon became the Champion speargun in the world.

1989 Cressi athlete Renzo Mazzarri wins the spearfishing world title in Italy.

HISTORY 1990'S

1990 Cressi continues its international expansion, opening Cressi subsidiaries in the United States and in Spain. Cressi products are by now distributed in over 90 countries world wide.

1992 Cressi athlete Renzo Mazzarri wins the spearfishing world title in Spain. It is the third title won by this incredible champion.

1995 Gara 2000 - The new Gara 2000 replaced the former Rondine Gara. A brand new, patented injection system of three different materials made it possible to obtain ultralight high performance fins. Another Cressi record that is still unbeaten today.

1997 XS regulators - The range of regulators welcomed the arrival of the XS series. Extremely high performing and the first stages were enriched with the diaphragm version that joined the traditional piston and balanced version.

1998 By-pass jacket - Cressi designed and produced a new by-pass for jackets, very simple and reliable, from then on fitted to the increasingly numerous range of BCs.

1999 Cressi Athlete Umberto Pelizzari sets the freediving "No Limits Absolute Variable Weight" World Record in Portofino (Italy) reaching the depth of 150 meters. Cressi Athlete Umberto Pelizzari sets the freediving "Constant Weight" World Record in Portofino (Italy) reaching the depth of 80 meters.

HISTORY 2000'S

2000 Big Eyes - Another great Cressi world patent. Big Eyes was the first mask in the world with raked lenses in an upside-down teardrop shape, an innovative form that gives the user a complete view of all the equipment worn. Big Eyes very shortly became the most widely copied and imitated mask in the world, a gratifying appreciation of how far ahead Cressi is in the design of its products. Computers - A full range of Cressi underwater computers was introduced onto the market in the 2000s. Visor, Archimede, Archimede 2 and Edy. They are all characterised by their extremely user friendly and reliable features.

2001 Cressi Athlete Umberto Pelizzari sets the freediving "Variable Weight" World Record in Capri (Italy) reaching the depth of 131 meters.

2004 Ellipse Titanium regulator - The newborn of the Cressi family in the regulators sector is a concentration of high technology, protected by some four world patents. It is small and very lightweight, but its performance places it with the elite in regulators. Another great Cressi record.

2004 Stefano Bellani wins the spearfishing world title in Chile. This is the 12th title won by a Cressi athlete, the company that has won the most spearfishing world titles in history.

2005 Cressi sponsors the Mizar expedition, an underwater expedition created to discover the famous World War II Italian cruiser "Armando Diaz" which lies in the bottom of the Mediterranean Sea in the Sicilian Channel.

2005 Cressi Swim - Cressi has also made a forceful entry into the sector of swimming equipment and apparel with a very wide range of products to meet all the needs of all swimmers, from the recreational enthusiast to the competitive swimmer.

2007 Cressi sponsors the Altair expedition, an underwater expedition organized in the Tunisian waters, to explore the wreck of the British cruiser "HMS Manchester" and to discover the wreck of the Italian cruiser "Da Giussano".

2009 Big Eyes Evolution - The revolutionary Big Eyes mask now has a successor. A legend evolves, a revolution begins.

2013 Today The Cressi company is still entirely owned by the Cressi family, which carries on, with the same passion as more than 60 years ago, the work started by brothers Nanni and Egidio Cressi.

In accordance with Directive 1999/44 EC, Cressi guarantees its products against inherent and operating defects. To offer better service to its customers and consumers, and to affirm the efficiency and quality of its manufacturing processes, it has decided to extend the terms of the guarantee as follows:

DIVE COMPUTERS Two (2) years from the date of purchase (for rental or teaching use: 12 months for operating defects and 24 months for inherent defects).

Exceptions: Flooding caused by incorrect battery installation, LCD display in the case of damage due to negligence or blows, damage due to leaks of substances from the battery (the guarantee is valid if the computer is new and has not been used), damage caused by dead or non-functioning batteries, damage due to negligence, blows, or to normal wear and tear.

ANALOG DEVICES Two (2) years from the date of purchase (for rental or teaching use: 12 months for operating defects and 24 months for inherent defects).

Exceptions: Damage due to negligence, blows, or normal wear and tear.

REGULATORS Two (2) years from the date of purchase (for rental or teaching use: 12 months for operating defects and 24 months for inherent defects).

Exceptions: Consumable parts, damage due to negligence, blows, or normal wear and tear.

B.C.D.'S Two (2) years from the date of purchase (for rental or teaching use: 12 months for operating defects and 24 months for inherent defects).

Exceptions: Consumable parts, damage due to scratches, punctures, abrasions, or chemical products (including chlorine), all damage due to exposure to the sun, damage due to negligence, blows, or normal wear and tear.

DRY SUITS Two (2) years from the date of purchase (for rental or teaching use: 6 months for operating defects and 24 months for inherent defects).

Exceptions: Consumable parts, damage due to scratches, punctures, abrasions, or chemical products (including chlorine), all damage due to exposure to the sun, damage due to negligence, improper use, blows, or normal wear and tear.

MASKS, FINS, MOUTHPIECES, GOGGLES Two (2) years from the date of purchase (for rental or teaching use: 12 months for good operations and 24 months for defects of conformity).

Exceptions: Alterations in the color of the silicone, all damage due to exposure to the sun or the effect of chemical or environmental agents, damage due to negligence, improper use, blows, or normal wear and tear.

SPEARGUNS, KNIVES, BAGS, WETSUITS, BOOTS, GLOVES, AND ALL REMAINING PRODUCTS AND CONSUMABLE PARTS

Two (2) years from the date of purchase (24 months for inherent flaws).

Exceptions: Damage due to scratches, punctures, abrasions, or chemical products (including chlorine), all damage due to exposure to the sun, damage due to negligence, blows, or normal wear and tear.



CRESSI

Atelier
offline product

THIS PRODUCT CAN ONLY BE SOLD OFFLINE,
IT IS NOT ALLOWED TO SELL IT ONLINE

INSTRUMENTS

CARTESIO
MICHELANGELO

REGULATORS

T10 SC CROMO / GALAXY ADJUSTABLE
T10 SC CROMO / GALAXY

BCD

COMMANDER EVOLUTION
CARBON

DIVE WEAR:

DESERT
COMFORT 7 mm
COMFORT 5 mm
TRACTION
GRIPPER

MASKS

ZEUS

SNORKELS

OMEGA ULTRA DRY

SPEARFISHING

KIOWA CUSTOM



CRESSI

Specialized
Retailer-Product

A HI-TECH PRODUCT RANGE FOR OUR PROFESSIONAL RETAILERS, THAT CAN BE SOLD ONLINE ONLY THROUGH THE OWN WEBSITE OF A CRESSI AUTHORIZED RETAILER. THIS RANGE THEREFORE CANNOT BE SOLD ON MARKETPLACES, E-PROCUREMENT PLATFORMS OR ANY THIRD PARTY WEBSITE.

INSTRUMENTS

NEON

DIGI2

REGULATORS

T10 SC MASTER

T10 SC CROMO MASTER CROMO

T10 SC CROMO COMPACT PRO

MC9 SC COMPACT PRO

OCTOPUS MG BALANCED

OCTOPUS COMPACT PRO

BCD

SCORPION

AQUARIDE

R1

AQUAPRO

DIVE WEAR

ICE

FACILE

FAST 7 mm

FAST 5 mm

FAST 3 mm

FISTERRA 8 mm

FISTERRA 5 mm

MEDAS



CRESSI

Specialized
Retailer-Product

A HI-TECH PRODUCT RANGE FOR OUR PROFESSIONAL RETAILERS, THAT CAN BE SOLD ONLINE ONLY THROUGH THE OWN WEBSITE OF A CRESSI AUTHORIZED RETAILER. THIS RANGE THEREFORE CANNOT BE SOLD ON MARKETPLACES, E-PROCUREMENT PLATFORMS OR ANY THIRD PARTY WEBSITE.

FINS

THOR EBS
ARA EBS
REACTION EBS
GARA MODULAR CARBON
GARA MODULAR NERY
GARA MODULAR LD
GARA MODULAR

MASKS

AIR

SPEARFISHING

CHEROKEE OCEAN
CHEROKEE OPEN
CHEROKEE
PACIFIC
COMANCHE RAIL
MOICANO
SAETTA PRO
SAETTA
SEPPIA
CORVINA
SCORFANO
TRACINA

ACCESSORIES

LUMIA

THE TOUGHEST AND MOST RELIABLE PRODUCTS SPECIFICALLY
ENGINEERED FOR RENTAL IN THE HARDEST CONDITIONS OF USE

INSTRUMENTS

LEONARDO
DIGI2

REGULATORS

AC2 COMPACT
OCTOPUS COMPACT

B.C.D.'S

SOLID

DIVE WEAR

DIVER 7 mm
DIVER 5 mm
ENDURANCE
ENDURANCE SHORTY
RASH GUARD LONG AND SHORT

FINS

FROG
FREE FROG

MASKS

MATRIX
SIRENA

SNORKELS

ISLAND

CRESSI
dive center

CRESSI

W A T C H E S

BUYER'S GUIDE 2019



CARTESIO

MADE IN ITALY BY
CRESSI ELETTRONICA

ALGORITHM
FOR MANAGING
TWO DIFFERENT
HYPER-OXYGENATED
MIXES DURING THE DIVE
PHASE. GAS1 21-50%
GAS2 21-99%

LONG-LIFE BATTERY

COMPACT (PATENTED)
ELECTRONIC MODULE

USER FRIENDLY MENU

4 OPERATIVE MODES



BLACK



BLACK METAL

NEW



COPPER

NEW

PRODUCT	CODE
CARTESIO BLACK	KS830050
N: CARTESIO BLACK METAL	KS830850
N: CARTESIO COPPER	KS830950

ELITE PROTECTIVE CASE



CRESSI
Atelier
offline product

MADE IN
ITALY

Cartesio has a diameter of only 48mm and a high contrast display of 35mm. It is a scuba diving/apnea watch-computer of extremely reduced dimensions. It is also an ideal watch for other underwater activities, thanks to the deactivation option of the "dive" functions that avoids unnecessary alarms ringing while you're snorkelling or swimming. The display is made of mineral glass and the case is heavy duty with steel buttons that have an underwater resistance of up to 120m. Rubber wrist band with stainless steel buckle.

TECHNICAL CHARACTERISTICS:

- High contrast display with extra large numbers
- Easy access menu
- 12/24 time format with calendar and seconds
- Precision stopwatch
- Second time setting
- Alarm clock
- Backlit display
- Surf time, desaturation and no fly time calculator
- Lets you know when battery is empty
- Metric or imperial units

AIR/NITROX PROGRAM

- CRESSI RGBM algorithm
- Complete diving data processor
- PPO2 1,2-1,6 configuration
- It is possible to select hyper-oxygenated mixes during the dive phase. GAS1 21-50% GAS2 21-99%
- Graphic indicator of CNS toxicity level of oxygen
- Safety stop indicator
- Multiple level safety factor configuration
- Altitude configuration
- Algorithm for managing uncontrolled ascent
- Suitable for repeated, multiday decompression diving
- It is possible to alternate between nitrox and air diving even during desaturation
- Visualisation of time at dive phase
- Add / remove deep stop
- Alarm in case of breach of ascent speed, decompression or PPO2
- It is possible to disable the ascent alarms
- Indicates time at dive phase
- Possibility of eventual total reset, useful for renting purposes
- Planning: scrolling of no-decompression limits

FREE (APNEA) PROGRAM

- Display of all diving parameters
- Depth
- Temperature
- Dive calculator
- Maximum dive depth
- Dive time
- Length of surface interval between each dive
- Length of diving session
- Depth, dive time and surface interval alarms
- Recovery time alarm
- Visualisation of time at dive phase

GAGE PROGRAM (without decompression calculator)

- Depth/temperature indicator
- Average depth
- Dive time in minutes and seconds
- Resettable depth stopwatch
- Visualisation of time at dive phase

OFF MODE

Sensors disabled for snorkelling/swimming activities

LOGBOOK up to 50 dives per category.

Optional INTERFACE with visualisation of diving profile

OPTIONAL ACCESSORIES

- STRAP EXTENSOR
- SILICONE PROTECTIVE LENS



PRODUCT	CODE
STRAP EXTENSOR	KZ810000
SILICONE PROTECTIVE LENS	KS890000

NEON

MADE IN ITALY BY
CRESSI ELETTRONICAALGORITHM FOR
MANAGING TWO
DIFFERENT HYPER-
OXYGENATED MIXES
DURING THE DIVE
PHASE. GAS1 21-50%
GAS2 21-99%

LONG-LIFE BATTERY

COMPACT (PATENTED)
ELECTRONIC MODULE

USER FRIENDLY MENU

4 OPERATIVE MODES



BLACK



BLUE



GREY



GREEN



ORANGE



RED



WHITE/LILAC

PRODUCT	CODE
NEON BLACK	KS840055
NEON BLUE	KS840020
NEON GREY	KS840050
NEON GREEN	KS840067
NEON ORANGE	KS840085
NEON RED	KS840058
NEON WHITE/LILAC	KS840141

ELITE PROTECTIVE CASE



NEW

Neon has a diameter of only 48 mm and a high contrast display of 37 mm. It is a scuba diving/apnea watch-computer of extremely reduced dimensions. It is also an ideal watch for other underwater activities, thanks to the deactivation option of the "dive" functions that avoids unnecessary alarms ringing while you're snorkeling or swimming. The display is made of mineral glass and the case is heavy duty with steel buttons that have an underwater resistance of up to 120 m. PTU rubber wrist band with stainless steel buckle.

TECHNICAL CHARACTERISTICS

- High contrast display with extra large numbers
- Easy access menu
- 12/24 time format with calendar and seconds
- Precision stopwatch
- Second time setting
- Alarm clock
- Backlit display
- Surf time, desaturation and no fly time calculator
- Lets you know when battery is empty
- Metric or imperial units

AIR/NITROX PROGRAM

- CRESSI RGBM algorithm
- Complete diving data processor
- PPO2 1.2-1.6 configuration
- It is possible to select hyper-oxygenated mixes during the dive phase. GAS1 21-50% GAS2 21-99%
- Graphic indicator of CNS toxicity level of oxygen
- Safety stop indicator
- Multiple level safety factor configuration
- Altitude configuration
- Algorithm for managing uncontrolled ascent
- Suitable for repeated, multiday decompression diving
- It is possible to alternate between nitrox and air diving even during desaturation
- Visualisation of time at dive phase
- Add / remove deep stop
- Alarm in case of breach of ascent speed, decompression or PPO2
- It is possible to disable the ascent alarms
- Indicates time at dive phase
- Device completely resettable, useful for renting purposes
- Planning: scrolling of no-decompression limits

FREE (APNEA) PROGRAM

- Display of all diving parameters
- Depth
- Temperature
- Dive calculator
- Maximum dive depth
- Dive time
- Length of surface interval between each dive
- Length of diving session
- Depth, dive time and surface interval alarms
- Recovery time alarm
- Visualisation of time at dive phase

GAGE PROGRAM (without decompression calculator)

- Depth/temperature indicator
- Average depth
- Dive time in minutes and seconds
- Resettable depth stopwatch
- Visualisation of time at dive phase

OFF MODE

- Sensors disabled for snorkelling/swimming activities

LOGBOOK up to 50 dives per category

Optional INTERFACE with visualisation of diving profile

OPTIONAL ACCESSORIES

- STRAP EXTENSOR
- SILICONE PROTECTIVE LENS



PRODUCT	CODE
STRAP EXTENSOR	KZ810000
SILICONE PROTECTIVE LENS	KS890000

GOA

MADE IN ITALY BY
CRESSI ELETTRONICA

LONG-LIFE BATTERY

COMPACT (PATENTED)
ELECTRONIC MODULE

USER FRIENDLY MENU

4 OPERATIVE MODES



The GOA has a diameter of only 48mm and a high contrast display of 35mm. It is a scuba diving/apnea watch-computer of extremely reduced dimensions. It is also an ideal watch for other underwater activities, thanks to the deactivation option of the "dive" functions that avoids unnecessary alarms ringing while you're snorkelling or swimming. The display is made of mineral glass and the case is heavy duty with steel buttons that have an underwater resistance of up to 120m. Rubber wrist band with stainless steel buckle. Plastic/Steel bezel and back cover.

TECHNICAL FEATURES

- High contrast display with extra large numbers
- Easy access menu
- 12/24 time format with calendar and seconds
- Precision stopwatch
- Second time setting
- Alarm clock
- Backlit display
- Surf time, desaturation and no fly time calculator
- Lets you know when battery is empty
- Metric or imperial units
- Long-lasting battery
- Battery replaceable by user

AIR/NITROX PROGRAM

- CRESSI RGBM algorithm
- Complete diving data processor
- PPO2 1,2-1,6 configuration
- Graphic indicator of CNS toxicity level of oxygen
- Safety stop indicator
- Multiple level safety factor configuration
- Altitude configuration
- Algorithm for managing uncontrolled ascent
- Suitable for repeated, multiday decompression diving
- It is possible to alternate between nitrox and air diving even during desaturation
- Visualisation of time at dive phase
- Add / remove deep stop
- Alarm in case of breach of ascent speed, decompression or PPO2
- It is possible to disable the ascent alarms
- Indicates time at dive phase
- Possibility of eventual total reset, useful for renting purposes
- Planning: scrolling of no-decompression limits

FREE (APNEA) PROGRAM

- Display of all diving parameters
- Depth
- Temperature
- Dive calculator
- Maximum dive depth
- Dive time
- Length of surface interval between each dive
- Length of diving session
- Depth, dive time and surface interval alarms
- Recovery time alarm
- Visualisation of time at dive phase

GAGE PROGRAM (without decompression calculator)

- Depth/temperature indicator
- Average depth
- Dive time in minutes and seconds
- Resettable depth stopwatch
- Visualisation of time at dive phase

OFF MODE

Sensors disabled for snorkelling/swimming activities

LOGBOOK up to 50 dives per category

Optional INTERFACE with visualisation of diving profile



PRODUCT	CODE
GOA BLACK/BLUE	KS820052
GOA BLACK/WHITE	KS820053
GOA BLACK/GREY	KS820050
GOA WHITE/PINK	KS820140
GOA WHITE/BLACK	KS820150



OPTIONAL ACCESSORIES

- STRAP EXTENSOR
- SILICONE PROTECTIVE LENS



PRODUCT	CODE
STRAP EXTENSOR	KZ810000
SILICONE PROTECTIVE LENS	KS890000

NEWTON TITANIUM

MADE IN ITALY

MADE IN ITALY BY
CRESSI ELETTRONICA

With a case diameter of just 48 mm, Newton Titanium is a truly compact dive watch computer. It's also the ideal tool out of the water as well, thanks to the option to deactivate the Dive program to prevent needless alarms or consumption while snorkeling, swimming, or just everyday use. The face is mineral glass and the watch has a heavy-duty reinforced case for resistance in the water down to -150 m. Rubber strap with stainless steel buckle.

TECHNICAL FEATURES

- 12/24 clock with minutes and seconds
- Calendar
- Precision stopwatch
- Second time setting
- Alarm clock
- Main computer function characteristics.
- Dual-mixture CRESSI RGBM algorithm New algorithm created through a collaboration between Cressi and Bruce Wienke based on the Haldane model, integrated with RGBM factors for safe decompression calculations in repetitive multi-day dives and with mixtures.
- Software handles two different hyperoxygenated mixtures, which can be selected during the dive.
- CRESSI RGBM Algorithm. New algorithm created through a collaboration between Cressi and Bruce Wienke based on the Haldane model, integrated with RGBM factors for safe decompression calculations in repetitive multi-day dives.
- Tissues: 9 saturation half-times ranging from 2.5 to 480 minutes;
- "Dive" Program: Full processing of dive data, including decompression if applicable, for every dive performed with Air or Nitrox.
- Full setting of F02 parameters (oxygen percentage) and PO2 (oxygen partial pressure) with the option to set PO2 between 1.2 bar and 1.6 bar, and F02 from 21% and 99%.
- Option to take a Nitrox dive after one with air (even while desaturating).
- Option to set Deco (decompression calculation) or Gage (depth gauge and timer).
- Deep stop can be turned on or off.
- Display with oversize digits.
- Planning: decompression curve scrolling.
- Metric or Imperial unit
- Visual and auditory alarms.
- Graphic CNS oxygen toxicity indicator.
- Backlit display
- Log book (70 hr or 60 dives) complete with dive profile.
- Dive history saved.
- Option for full reset if needed, helpful when renting the device.
- PC/Mac interface with simulator and dive profile (optional).



PRODUCT	CODE
NEWTON TITANIUM BLACK/BLACK	KS800055
NEWTON TITANIUM BLACK/GREY	KS800050
NEWTON TITANIUM BLACK/BLUE	KS800052
NEWTON TITANIUM BLACK/PINK	KS800054
NEWTON TITANIUM BLACK/YELLOW	KS800150
NEWTON TITANIUM BLACK/RED	KS800058

ELITE PROTECTIVE CASE



STRAP EXTENSOR

OPTIONAL



STRAP EXTENSOR



PRODUCT	CODE
STRAP EXTENSOR	KZ810000

DRAKE TITANIUM



MADE IN ITALY BY
CRESSI ELETTRONICA



Drake is a revolutionary diving computer that not only gives information about deep diving, but with its special four programs it can also assist the diver in dynamic breath hold diving, static breath hold diving and underwater fishing. In fact, in its operating system the diver can choose between these four programs: The PRO program is particularly suitable for diving purists and extreme divers. It provides, among other information, the descent speed, ascent speed and total speed, duration of descent and ascent, "Time Ratio" between immersion time and the surface time (constantly updated), medium data and the useful function of Recommended Recovery Time for safety, set by the user for the prevention of Taravana.

The FREE program provides easy reading of and access to data. It is suitable for sea-running and underwater fishing and provides the necessary information on the most visible part of the display. By limiting the accessory data that characterize the program, PRO helps the diver to focus on the more practical aspects of the discipline.

The DYNAMIC program is for those who are training or practice the discipline horizontally. It has a special tank counter and has the ability to memorize training tables with times expressed in increments or decrements.

The STATIC program totally controls static breath hold diving, both for training and for performance.



BLACK

MIMETIC

ELITE PROTECTIVE CASE



PRODUCT	CODE
DRAKE TITANIUM	KS810055
DRAKE TITANIUM MIMETIC	KS810095



drake provides a
RECOMMENDED
RECOVERY TIME (RRT)
ALARM FOR FREE
AND PRO PROGRAMS

4 DIFFERENT PROGRAMS

FREE MODE FREEDIVING (ENDURANCE)

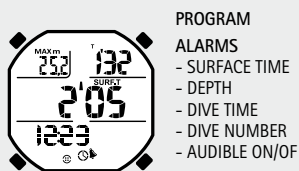

PROGRAM

ALARMS
- SURFACE TIME
- DEPTH
- DIVE TIME
- DIVE NUMBER
- AUDIBLE ON/OFF

PRO MODE DEEP FREEDIVING (EVOLUTE)



PROGRAM ALARMS

- SURFACE TIME
- DEPTH
- DIVE TIME
- DIVE NUMBER
- AUDIBLE ON/OFF
- AUTOMATIC LIGHTENING
- DEPTH STEP

STATIC MODE STATIC APNEA



PROGRAM ALARMS

- SURFACE TIME
- DIVE TIME
- DIVE NUMBER
- REPETITIONS

DYNAMIC MODE DYNAMIC APNEA



PROGRAM ALARMS

- SURFACE TIME
+ DIVE TIME
- SURFACE TIME
- DIVE TIME
- DIVE RUN COUNTER
- REPETITIONS

STRAP EXTENSOR

OPTIONAL



STRAP EXTENSOR



PRODUCT	CODE
STRAP EXTENSOR	KZ810000

BT INTERFACE WATCHES



BLUETOOTH/USB

- CARTESIO
- NEON
- GOA



NEW



External docking station to send data to your smartphone – compatible with Android (from OS version 7.0 onwards) and iOS (from OS version 10 onwards) – or to transfer data on PC (from Windows 7 onwards) and Mac (from Yosemite onwards) through USB connection.

The docking station is equipped with a CR 2032 battery included and replaceable by the user, which allows not to consume the internal battery of the dive computer.

The specific App is available on the Google Play Store and App Store.



DOWNLOAD
CRESSI APP
AND EXPLORE
YOUR DIVES
ON YOUR
SMARTPHONE



USB CABLE INCLUDED



AVAILABLE FOR



MINIMUM REQUIREMENTS
WINDOWS 7 AND OSX 10.10 (64 BIT)

PRODUCT	CODE
BT INTERFACE WATCHES	KS822000

INTERFACE

- CARTESIO
- NEON
- GOA



AVAILABLE FOR



MINIMUM REQUIREMENTS
WINDOWS 7 AND OSX 10.10 (64 BIT)

This interface makes it possible to download
your dives and view the relative charts and data.



PRODUCT	CODE
CARTESIO-NEON-GOA INTERFACE	KS821000

INTERFACE

- NEWTON
- DRAKE



AVAILABLE FOR



WINDOWS XP - VISTA - 7 - 8
MAC FROM OS 10.9 TO OS 10.10

The new interface for Newton and Drake electronic
instruments allows you to download dives onto your
computer desktop and complete the analysis of additional
data otherwise not available on the underwater unit.



PRODUCT	CODE
NEWTON - DRAKE INTERFACE	KS801000

SILICONE PROTECTIVE LENS



- CARTESIO
- GOA
- NEON
- NEWTON TITANIUM
- DRAKE TITANIUM



MAGNIFYING EFFECT
+ 15% LARGER
NUMERICAL DISPLAYS



PRODUCT	CODE
SILICONE PROTECTIVE LENS	KS890000



The lens eliminates almost completely the effects of abrasion and shocks on both the display and the sides of the bezel, while making for perfect visibility. Thanks to this protection, the dive computer retains its pleasing, undamaged appearance even after prolonged, intensive underwater use.



CRESSI

COMPUTERS

BUYER'S GUIDE 2019

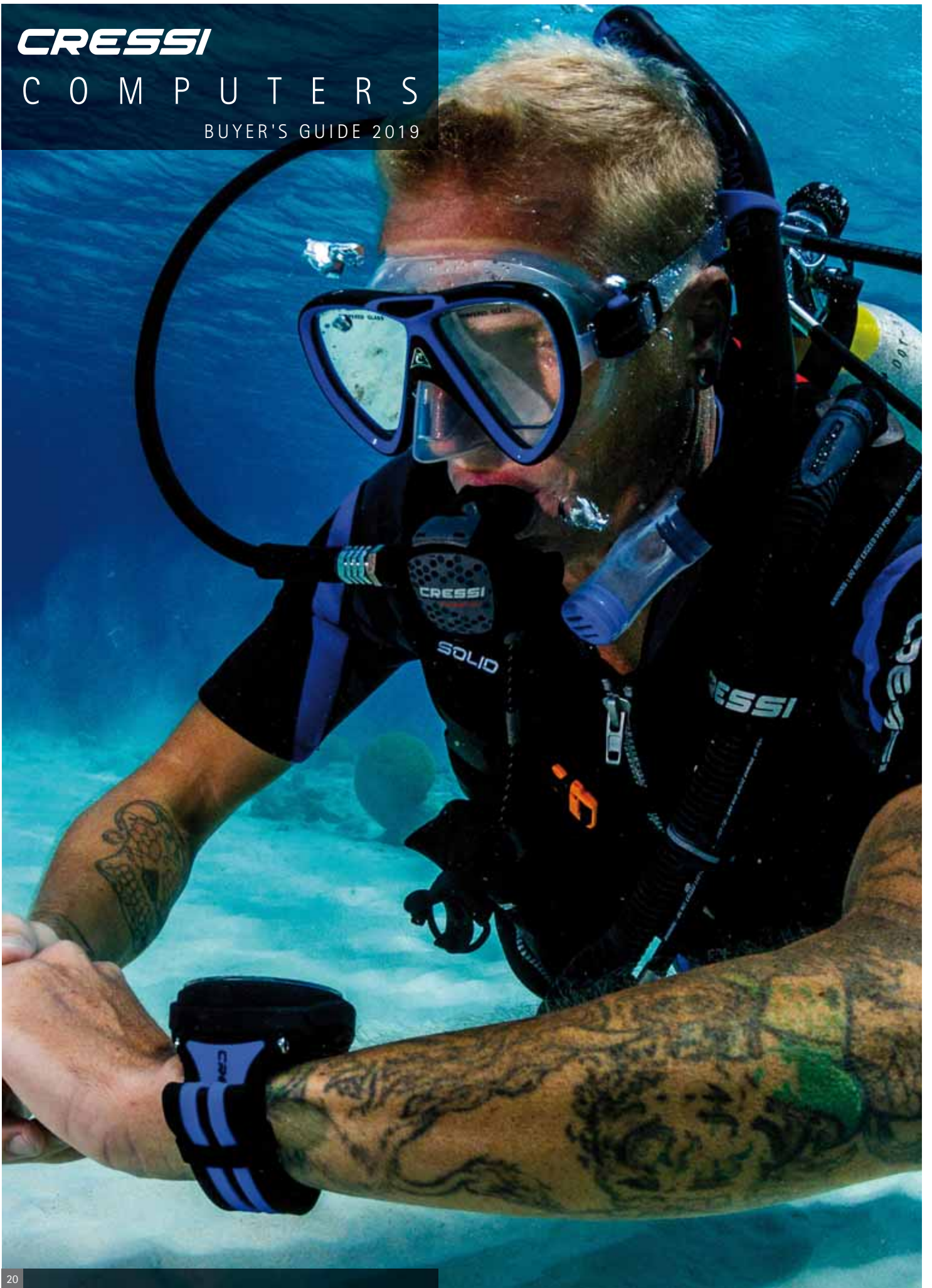

MICHELANGELO

MADE IN ITALY BY
CRESSI ELETTRONICA

ALGORITHM
FOR MANAGING TWO
DIFFERENT
HYPER-OXYGENATED
MIXES DURING THE DIVE
PHASE. GAS1 21-50%
GAS2 21-99%

FREEDIVE FUNCTIONS



BLACK



COPPER

PRODUCT	CODE
MICHELANGELO BLACK	KS850050
MICHELANGELO COPPER	KS850950

CRESSI
Atelier
offline product

MADE IN
ITALY

NEW



Michelangelo has a high contrast display. It is a scuba diving/apnea computer. It is an ideal computer for other underwater activities, thanks to the deactivation option of the "dive" functions that avoids unnecessary alarms ringing while you're snorkeling or swimming. The display is made of technical polyolefin and the case is heavy duty, with a steel button. The underwater resistance is up to 150 m. TPU rubber wrist band with stainless steel buckle.

TECHNICAL CHARACTERISTICS

- High contrast display with extra large numbers
- Easy access menu
- 12/24 time format with calendar
- High power backlight display
- Surf time, desaturation and no fly time calculator
- Lets you know when battery is empty
- Metric or imperial units

AIR/NITROX PROGRAM

- CRESSI RGBM algorithm
- Complete diving data processor
- PPO2 1.2-1.6 configuration
- It is possible to select hyper-oxygenated mixes during the dive phase. GAS1 21-50% GAS2 21-99%
- Graphic indicator of CNS toxicity level of oxygen
- Safety stop indicator
- Multiple level safety factor configuration
- Altitude configuration
- Algorithm for managing uncontrolled ascent
- Suitable for repeated, multiday decompression diving
- It is possible to alternate between nitrox and air diving even during desaturation
- Visualisation of time while diving
- Add / remove deep stop
- Alarm in case of breach of ascent speed, decompression or PPO2
- It is possible to disable the ascent alarms
- Possibility of eventual total reset, useful for renting purposes
- Planning: scrolling of no-decompression limits
- Maximum dive depth alarm

FREE (APNEA) PROGRAM

- Display of all diving parameters
- Depth
- Temperature
- Dive calculator
- Maximum dive depth alarm
- Dive time
- Length of surface interval between each dive
- Length of diving session
- Depth, dive time and surface interval alarms
- Recovery time alarm
- Visualisation of time at dive phase

GAGE PROGRAM (without decompression calculator)

- Depth/temperature indicator
- Average depth
- Dive time in minutes and seconds
- Resettable depth stopwatch
- Visualisation of time at dive phase

LOGBOOK up to 50 dives per category

Replaceable protective display screen
User-replaceable batteries

Structural metal bezel that gives greater impact resistance

Optional INTERFACE with visualisation of diving profile

ELITE PROTECTIVE CASE



GIOTTO

MADE IN ITALY BY
CRESSI ELETTRONICA

TECHNICAL FEATURES

Dual-mixture CRESSI RGBM algorithm.

New algorithm created through a collaboration between Cressi and Bruce Wienke based on the Haldane model, integrated with RGBM factors for safe decompression calculations in repetitive multi-day dives and with mixtures. Software handles two different hyper-oxygenated mixtures, which can be selected during the dive.

- Tissues: 9 saturation half-times ranging from 2.5 to 480 minutes
- "Dive" Program: Full processing of dive data, including decompression if applicable, for every dive performed with Air or Nitrox
- Full setting of FO2 parameters (oxygen percentage) and PO2 (oxygen partial pressure) with the option to set PO2 between 1.2 bar and 1.6 bar, and FO2 from 21% and 99%
- Option to take a Nitrox dive after one with air (even while desaturating)
- Gauge setting option (depth gauge and timer)
- Deep stop can be turned on or off
- Replaceable protective display screen
- User-replaceable batteries
- Planning: decompression curve scrolling
- User can switch units of measure from Metric (meters and C°) to Imperial (feet and F°)
- Visual and auditory alarms
- Graphic CNS oxygen toxicity indicator
- Backlit display
- Built-in calendar and clock.
- Log book (70 hr or 60 dives) complete with dive profile
- Dive history saved
- Option for full reset if needed, helpful when renting the device



BLACK/BLACK



BLACK/WHITE



BLACK/GREY



BLACK/BLUE



BLACK/RED



BLACK/PINK

PRODUCT	CODE
GIOTTO BLACK/BLACK	KS740055
GIOTTO BLACK/WHITE	KS740150
GIOTTO BLACK/GREY	KS740050
GIOTTO BLACK/BLUE	KS740052
GIOTTO BLACK/RED	KS740058
GIOTTO BLACK/PINK	KS740054

ELITE PROTECTIVE CASE



GIOTTO CONSOLE 2



PRODUCT	CODE
GIOTTO CONSOLE 2 BAR	KS750000
GIOTTO CONSOLE 2 PSI	KS750050

PRESSURE GAUGE

Make gauge checks fast and efficient with this two-gauge console especially crafted for the Leonardo. Polycarbonate materials and smart features make this angled console rugged, lightweight and user-friendly. The angled console combines the Leonardo with a brass-housed, mini Submersible Pressure Gauge that has a color-coded scale divers can read at a glance.

TECHNICAL FEATURES

- Polycarbonate and desmopan materials are lightweight and minimize bulk for reduced drag.
- Two connection points, one up top for a clip or bungee and wide loops on the back for connection to any strap, give divers the greatest number of mounting options.
- Angled console fits naturally in the hand and positions both the pressure gauge and computer for optimal viewing.
- Rugged mini-gauge has a chrome-plated brass case.
- Console is easy to assemble with each component.
- Gauge dial is color-coded in red, green and blue for instant readability.
- Reads pressures to 350 bar or 5000 psi.
- Console measures 65 mm x 25 mm.
- Weight with whip and 2 HP tools: 480 g

ELITE
PROTECTIVE
CASE



GIOTTO CONSOLE 3



PRODUCT	CODE
GIOTTO CONSOLE 3 BAR	KS750060
GIOTTO CONSOLE 3 PSI	KS750070

COMPASS
+ PRESSURE GAUGE

ELITE
PROTECTIVE
CASE



LEONARDO

MADE IN ITALY BY
CRESSI ELETTRONICAMADE IN
ITALY

An elegant expression of simple, functional design, the Leonardo is a must-have for divers entering the sport and those who "just want to dive." A single button interface makes it effortless to program Air, Nitrox and Gauge modes the first time a diver picks the computer up, and an edge-to-edge, high-definition screen gives large numerical displays in a computer that is still compact and travel-friendly. The clearly visible battery life indicator and distinct audible alarms deliver critical information as well as peace-of-mind during the dive. The Leonardo can also be fully re-set after each use, making it an excellent choice for rental departments

TECHNICAL FEATURES

- Air, Nitrox and Gauge modes
- FO₂ adjustable between 21% and 50%
- PO₂ adjustable between 1.2 bar and 1.6 bar
- CNS oxygen toxicity graphic indicator
- Single button interface (short push changes function, longer push selects functions)
- Three levels of user-adjustable conservatism
- User-selectable Deep Stop function
- Modified Haldne and Wienke algorithm
- Ascent rate alarm (10 m per minute)
- Log book for 60 dives/75 hours of information with 20-second samplingrate
- Battery life indicator
- Distinct, easy-to-hear audible alarms
- User changeable battery
- Adjustable unit of measure: English or Metric
- Backlit display
- Built-in calendar and clock
- Possibility of eventual total reset, useful for renting purposes
- PC/Mac interface with simulator and dive profile (optional)



BLACK/BLACK



BLACK/GREY



BLACK/BLUE



BLACK/YELLOW



BLACK/PINK



WHITE/BLACK

PRODUCT	CODE
LEONARDO BLACK/BLACK	KS770000
LEONARDO BLACK/GREY	KS770050
LEONARDO BLACK/BLUE	KS770052
LEONARDO BLACK/PINK	KS770054
LEONARDO WHITE/BLACK	KS770150
LEONARDO BLACK/YELLOW	KS770051
LEONARDO DIVE CENTER EDITION	JKS770200



LEONARDO CONSOLE 2



PRODUCT	CODE
LEONARDO CONSOLE 2 BAR	KS780000
LEONARDO CONSOLE 2 PSI	KS780050

PRESSURE GAUGE

Make gauge checks fast and efficient with this two-gauge console especially crafted for the Leonardo. Polycarbonate materials and smart features make this angled console rugged, lightweight and user-friendly. The angled console combines the Leonardo with a brass-housed, mini Submersible Pressure Gauge that has a color-coded scale divers can read at a glance.

TECHNICAL FEATURES

- Polycarbonate and desmopan materials are lightweight and minimize bulk for reduced drag.
- Two connection points, one up top for a clip or bungee and wide loops on the back for connection to any strap, give divers the greatest number of mounting options.
- Angled console fits naturally in the hand and positions both the pressure gauge and computer for optimal viewing.
- Rugged mini-gauge has a chrome-plated brass case.
- Console is easy to assemble with each component.
- Gauge dial is color-coded in red, green and blue for instant readability.
- Reads pressures to 350 bar or 5000 psi.
- Console measures 65 mm x 25 mm.
- Weight with whip and 2 HP tools: 480 g

ELITE
PROTECTIVE
CASE



LEONARDO CONSOLE 3



PRODUCT	CODE
LEONARDO CONSOLE 3 BAR	KS790000
LEONARDO CONSOLE 3 PSI	KS790050

COMPASS
+ PRESSURE GAUGE

Version three instruments of Leonardo Console: Leonardo, mini Submersible Pressure Gauge and Compass. Polycarbonate and Desmopan materials.

ELITE
PROTECTIVE
CASE



BT INTERFACE

BLUETOOTH/USB

- MICHELANGELO



NEW



External docking station to send data to your smartphone – compatible with Android (from OS version 7.0 onwards) and iOS (from OS version 10 onwards) – or to transfer data on PC (from Windows 7 onwards) and Mac (from Yosemite onwards) through USB connection.

The docking station is equipped with a CR 2032 battery included and replaceable by the user, which allows not to consume the internal battery of the dive computer.

The specific App is available on the Google Play Store and App Store.



DOWNLOAD
CRESSI APP
AND EXPLORE
YOUR DIVES
ON YOUR
SMARTPHONE

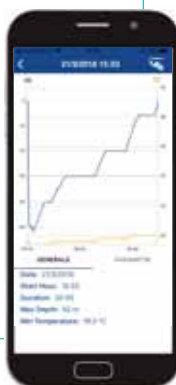

USB CABLE INCLUDED



AVAILABLE FOR



MINIMUM REQUIREMENTS
WINDOWS 7 AND OSX 10.10 (64 BIT)

INTERFACE

- LEONARDO
- GIOTTO



AVAILABLE FOR



WINDOWS XP - VISTA - 7 - 8
MAC FROM OS 10.9 TO OS 10.10

Divers have the ability to fully manage the data and functions of their Leonardo computer with this PC Interface. It's easy to connect both wrist and console mounted units, which simply sit on top of the USB-powered interface. The system is compatible with both Windows and Mac operating systems.

TECHNICAL FEATURES

- Interface works with both wrist and console units
- Connects through any USB port.
- Upload dive data and manage computer functions
- Green indicator light confirms when positive connection established.
- PC interface software compatible with both Windows 7 and Mac operating systems.



PRODUCT	CODE
LEONARDO - GIOTTO INTERFACE	KS771000



DIGI 2

DIGITAL CONSOLE



NEW

PRESSURE GAUGE + DEPTH GAUGE

AUTOMATIC ACTIVATION WITH CONNECTION TO THE TANK

RESIDUAL GAS AUTONOMY INDICATOR (IN MINUTES)

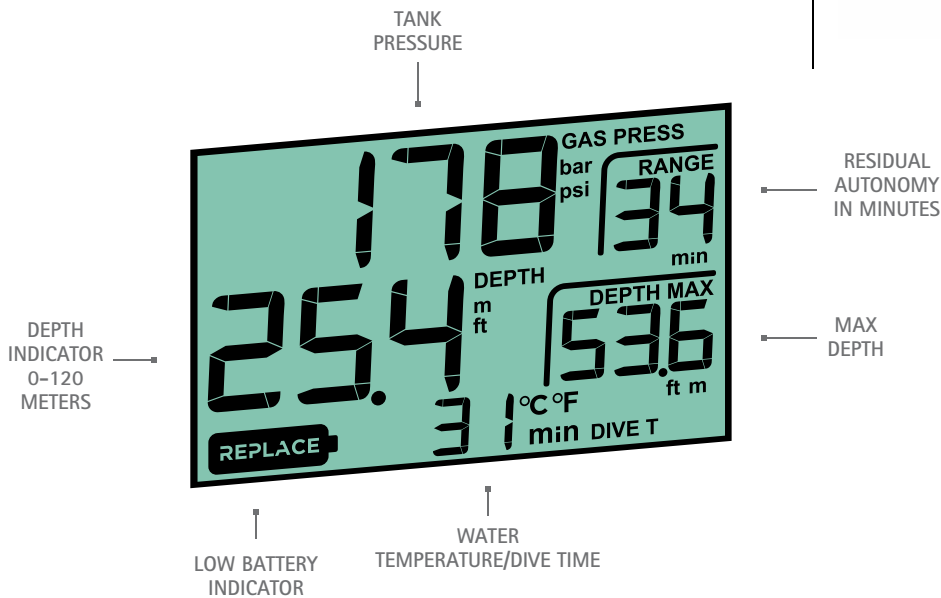

SELF-DIAGNOSIS FOR BATTERY CHANGE (PATENTED)

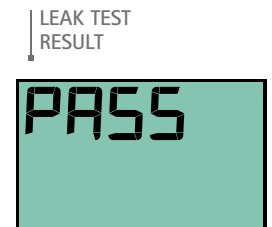
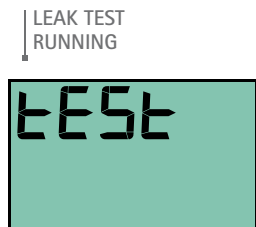

DIGI 2

DIGITAL CONSOLE

NEW



BLACK



WHITE



BLUE



GREY



PINK



Designed for the harshest conditions, this extremely precise console is also easy to be used.

TECHNICAL FEATURES

- Automatic activation with connection to the tank
- High contrast display
- Depth indicator 0-120 meters
- Tank pressure indicator 0-300 bar
- Water temperature indicator -10/+50 °C
- Residual gas autonomy in minutes indicator
- Gas reserve below 50 bar indicator
- Maximum depth of the last dive
- Autonomy up to 1000 hours in immersion
- Low battery indicator
- Self-diagnosis for battery change (patented)
- Dedicated smartbox that allows you to interact (patented)
- User-replaceable silicone protective shell
- Dimensions: 9.9 x 5.2 x 2.8 cm
- Weight: 122 gr

PRODUCT	CODE
DIGI 2 BLACK	KC800055
DIGI 2 WHITE	KC800030
DIGI 2 BLUE	KC800020
DIGI 2 GREY	KC800050
DIGI 2 PINK	KC800040
 DIGI 2 DIVE CENTER EDITION	JKC800058

CONSOLE CP2



COMPASS + PRESSURE GAUGE

Compact and built to last, this console combines a Mini SPG and a compass. The textured boot is easy to handle, even while wearing gloves, and can be rigged with a clip or bungee and secured to the diver's BC for a streamlined profile in the water.

TECHNICAL FEATURES

- Compass with rotating bezel for easy navigation
- Pressure gauge dial is color-coded in red, green and blue for instant readability.
- Reads pressures to 350 bar or 5000 psi.
- Both instruments built with chrome-plated brass case for maximum durability.
- Compact rubber boot is textured for a sure grip.
- Two connection loops, one on each side, for attaching a clip or bungee.
- Weight of console: 420 g (includes hose).

PRODUCT	CODE
CONSOLE CP2 BAR	KC764350
CONSOLE CP2PSI	KC765350

CONSOLE PD2



PRESSURE GAUGE + DEPTH GAUGE

Compact and built to last, this two-gauge console combines a Mini SPG and depth gauge. The textured boot is easy to handle, even while wearing gloves, and can be rigged with a clip or bungee and secured to the diver's BC for a streamlined profile in the water.

TECHNICAL FEATURES

- Pressure gauge dial is color-coded in red, green and blue for instant readability.
- Reads pressures to 350 bar or 5000 psi.
- Mini-depth gauge reads to 70 meters (230 feet)
- Maximum depth indicator.
- Luminescent face on the depth gauge.
- Depth indications spaced out in first 12 meters (40 feet) for precise readings during safety stops.
- Both instruments built with chrome-plated brass case for maximum durability.
- Compact rubber boot is textured for a sure grip.
- Two connection loops, one on each side, for attaching a clip or bungee.
- Weight of console: 420 g (includes hose).

PRODUCT	CODE
CONSOLE PD2 BAR	KC764550
CONSOLE PD2 PSI	KC764650

CONSOLE CPD3



COMPASS + PRESSURE GAUGE + DEPTH GAUGE

- Compass with rotating bezel for easy navigation
- Pressure gauge dial is color-coded in red, green and blue for instant readability.
- Reads pressures to 350 bar or 5000 psi.
- Mini-depth gauge reads to 70 meters (230 feet)
- Maximum depth indicator.
- Compact rubber boot is textured for a sure grip.
- Two connection loops, one on each side, for attaching a clip or bungee.
- Weight of console: 420 g (includes hose)

PRODUCT	CODE
CONSOLE CPD3 BAR	KC764460
CONSOLE CPD3 PSI	KC764455

CONSOLE 2



DEPTH GAUGE + PRESSURE GAUGE

Compact and built to last, this two-gauge console combines a Mini SPG and depth gauge. The textured boot is easy to handle, even while wearing gloves, and can be rigged with a clip or bungee and secured to the diver's BC for a streamlined profile in the water.

TECHNICAL FEATURES

- Pressure gauge dial is color-coded in red, green and blue for instant readability.
- Reads pressures to 350 bar or 5000 psi.
- Mini-depth gauge reads to 70 meters (230 feet)
- Maximum depth indicator.
- Luminescent face on the depth gauge.
- Depth indications spaced out in first 12 meters (40 feet) for precise readings during safety stops.
- Both instruments built with chrome-plated brass case for maximum durability.
- Compact rubber boot is textured for a sure grip.
- Two connection loops, one on each side, for attaching a clip or bungee.
- Weight of console: 420 g (includes hose).

PRODUCT	CODE
CONSOLE 2 BAR	KC764250
CONSOLE 2 PSI	KC765250

PRESSURE GAUGE



TECHNICAL FEATURES

- Gauge dial is color-coded in red, green and blue for instant readability.
- Reads pressures to 350 bar or 5000 psi.
- Rugged mini-gauge has a chrome-plated brass case.
- Compact rubber boot is textured for a sure grip.
- Connection loop up-top is perfect for attaching a clip or bungee.

PRODUCT	CODE
PRESSURE GAUGE BAR	KK760300
PRESSURE GAUGE PSI	KK760400

COMPASS

COMPASS WORKS BOTH
FOR THE NORTHERN AND SOUTHERN HEMISPHERES



WITH STRAP AND BCD HOLDER



Robust and accurate compass for underwater navigation that ensures accuracy and durability for a long time. The compass perfect for travelers.
Scratch-resistant and durable oil-filled polycarbonate case.
Highly luminous dial for easy reference in low light conditions.
Side view window for easy and accurate navigation.

PRODUCT	CODE
COMPASS + FIXING KIT	KB760100

INSTRUMENTS BAGS

CONSOLE BAG

COMPUTER BAG



PRODUCT	CODE
COMPUTER BAG	UB940040
CONSOLE BAG	UB940050

MAIN COMPUTER SPARE PARTS

FOR THE FULL LIST,
SEE OUR
SPARE PARTS
CATALOGUE



WATCHES SPARE PART	CODE
STRAP FOR NEON BLACK	KZ840055
STRAP FOR NEON BLUE	KZ840020
STRAP FOR NEON GREY	KZ840050
STRAP FOR NEON GREEN	KZ840067
STRAP FOR NEON ORANGE	KZ840085
STRAP FOR NEON RED	KZ840058
STRAP FOR NEON WHITE/LILAC	KZ840141
STRAP FOR NEWTON BLACK/GREY	KZ800050
STRAP FOR NEWTON BLACK/BLUE	KZ800052
STRAP FOR NEWTON BLACK/PINK	KZ800054
STRAP FOR NEWTON BLACK	KZ800055
STRAP FOR NEWTON BLACK/YELLOW	KZ800150
STRAP FOR NEWTON BLACK/RED	KZ800058
STRAP FOR DRAKE MIMETIC	KZ800095
STRAP FOR GOA BLACK/GREY	KZ820050
STRAP FOR GOA BLACK/BLUE	KZ820052
STRAP FOR GOA BLACK/WHITE	KZ820053
STRAP FOR GOA WHITE/BLACK	KZ820150
STRAP FOR GOA WHITE/PINK	KZ820140
STRAP FOR CARTESIO BLACK	KZ8230050
BATTERY KIT FOR WATCHES	KZ805094
SCREW WITH NUT FOR WATCHES	KZ805099

COMPUTER SPARE PARTS	CODE
PROTECTIVE PLASTIC COVER FOR MICHELANGELO	KZ850098
PROTECTIVE PLASTIC COVER FOR GIOTTO	KZ740098
STRAP FOR GIOTTO BLACK/GREY	KZ740050
STRAP FOR GIOTTO BLACK/BLUE	KZ740052
STRAP FOR GIOTTO BLACK/RED	KZ740058
STRAP FOR GIOTTO WHITE/BLACK	KZ740150
STRAP FOR GIOTTO BLACK/MICHELANGELO	KZ740055
STRAP FOR LEONARDO BLACK	KZ770000
STRAP FOR LEONARDO BLACK/BLUE	KZ770020
STRAP FOR LEONARDO BLACK/PINK	KZ770040
STRAP FOR LEONARDO BLACK/GREY	KZ770050
STRAP FOR LEONARDO WHITE/BLACK	KZ770150
STRAP FOR LEONARDO BLACK/YELLOW	KZ770051
PROTECTIVE PLASTIC COVER FOR LEONARDO	KZ770098
BATTERY KIT FOR COMPUTERS	KZ770094
SCREW WITH NUT FOR COMPUTERS	KZ760525

INSTRUMENTS SPARE PARTS	CODE
DIGI2 COVER BLACK	KZ790055
DIGI2 COVER BLUE	KZ790020
DIGI2 COVER GREY	KZ790050
DIGI2 COVER WHITE	KZ790030
DIGI2 COVER PINK	KZ790040
DIGI2 COVER RED	KZ790058
HP HOSE	KZ760501
U/W CONT. GAUGE CAPSULE W/HOSE	KZ760502
DEPTH GAUGE CAPSULE MT	KZ760504
COMPASS FOR CONSOLE 3	KZ764199

	CODE
ELITE PROTECTIVE CASE	KZ700000



CRESSI

R E G U L A T O R S

BUYER'S GUIDE 2019



T10 SC CROMO GALAXY ADJUSTABLE

1ST STAGE T10 SC CROMO

2ND STAGE GALAXY ADJUSTABLE



PRODUCT	CODE
T10 SC CROMO GALAXY ADJUSTABLE - INT	HX890000
T10 SC CROMO GALAXY ADJUSTABLE - DIN	HX890100



T10 SC CROMO GALAXY ADJUSTABLE - INT



T10 SC CROMO GALAXY ADJUSTABLE - DIN



CERTIFICATION EN250/2014 FOR COLD WATER

THE T10-SEAL CHAMBER CROMO 1ST STAGE is environmentally sealed, protecting it against icing in cold water and against contamination from particulate matter in silty conditions. When paired with the Master second stage, which includes an internal heat exchanger, this regulator is an excellent choice for divers exploring the most extreme cold water environments.



NEW

RESULTS: INHALE PRESSURE,
EXHALE PRESSURE AND EXT WORK OF BREATHING

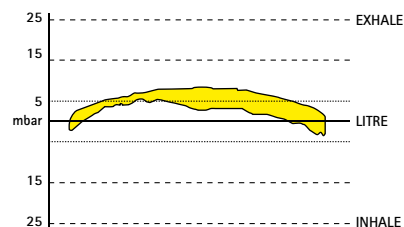

Perf. over 50 mt	
Perf. up to 50 mt	
Lightness	
Easiness of breathing	
Cold water perf. T10-SC	
	0 1 2 3 4 5 6 7 8 9 10
	Certification in accordance with EN250 standard

TOTAL WEIGHT

T10-SC/MASTER CROMO INT HOSE INCLUDED: 1075 GR

T10-SC/MASTER CROMO DIN HOSE INCLUDED: 957 GR

Very high performance regulator, same mechanics as the T10 Master but without the double stage regulator. Ideal for seasoned or professional divers who need extremely high performing equipment that is both simple and resistant, without any of the usual accessories that may get damaged.

TECHNICAL FEATURES 1ST STAGE

- Hyperbalanced diaphragm (Watertight chamber on T10-SC)
- 2 HP 7/16 UNF ports
- 4 MP 3/8 UNF ports
- Operating pressure: 300 bar (4350 psi) DIN Version, 232 bar (3365 psi) International version
- Calibration pressure: 10 bar
- High-capacity conical filter in chemically nickel-plated spherical bronze
- Removable nozzle in AISI 316 steel
- Hyperbalancing system
- Anti-pressure drop pneumatic spring
- Stainless steel calibration spring with micropeening treatment
- Low-friction technopolymer slider shaft
- Body protection in polyurethane thermoplastic
- Quantity of air supplied: 4500 l/min
- Weight, INT version: 720 gr
- Weight, DIN version: 602 gr

TECHNICAL FEATURES 2ND STAGE

- Pneumatically balanced
- Adjustable Venturi
- Adjustable inhalation effort
- Patented elliptical diaphragm
- Patented low-friction lever
- Air delivery system without injector
- Adjuster knob coated with dual OR
- Internal heat exchanger
- Cap opening with Cam-lock
- Noise-absorbing technopolymer body
- Removable technopolymer deflector
- Removable mechanics
- Weight without hose: 202 gr

COMBINATION PERFORMANCE

- Average Cracking effort 3.5 mbar
- Average breathing effort 0.6 J/l

JACKETED HOSE extremely light and flexible weight: 153 gr

CERTIFICATION EN250/2014 FOR COLD WATER



ELITE
PACKAGING

T10 SC CROMO GALAXY

1ST STAGE T10 SC CROMO

2ND STAGE GALAXY



PRODUCT	CODE
T10 SC CROMO GALAXY - INT	HX845000
T10 SC CROMO GALAXY - DIN	HX845100



T10 SC CROMO GALAXY - INT



T10 SC CROMO GALAXY - DIN



NEW

RESULTS: INHALE PRESSURE, EXHALE PRESSURE AND EXT WORK OF BREATHING

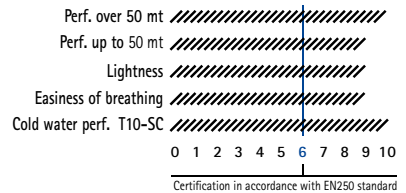
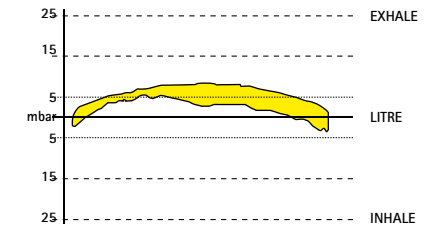

TOTAL WEIGHT

T10 SC CROMO/GALAXY INT HOSE INCLUDED: 1075 GR

T10 SC CROMO/GALAXY DIN HOSE INCLUDED: 957 GR

Very high performance regulator, same mechanics as the T10 Master but without the double stage regulator. Ideal for seasoned or professional divers who need extremely high performing equipment that is both simple and resistant, without any of the usual accessories that may get damaged.

TECHNICAL FEATURES 1ST STAGE

- Hyperbalanced diaphragm (Watertight chamber on T10-SC)
- 2 HP 7/16 UNF ports
- 4 MP 3/8 UNF ports
- Operating pressure: 300 bar (4350 psi) DIN Version, 232 bar (3365 psi) International version
- Calibration pressure: 10 bar
- High-capacity conical filter in chemically nickel-plated spherical bronze
- Removable nozzle in AISI 316 steel
- Hyperbalancing system
- Anti-pressure drop pneumatic spring
- Stainless steel calibration spring with micropeening treatment
- Low-friction technopolymer slider shaft
- Body protection in polyurethane thermoplastic
- Quantity of air supplied: 4500 l/min
- Weight, INT version: 720 gr
- Weight, DIN version: 602 gr

TECHNICAL FEATURES 2ND STAGE

- Pneumatically balanced
- Adjustable Venturi valve
- Patented elliptic diaphragm
- Patented reduced friction lever
- No-injector air release system
- Internal heat exchange system
- Cam-lock cap lock
- Anti noise component made of engineering plastic
- Detachable lip made of engineering plastic
- Removable mechanical parts
- Weight without the hose: 182 gr

COMBINATION PERFORMANCE

- Average Cracking effort 3.5 mbar
- Average breathing effort 0.6 J/l

JACKETED HOSE extremely light and flexible weight: 153 gr

CERTIFICATION EN250/2014 FOR COLD WATER



ELITE PACKAGING



CERTIFICATION EN250/2014 FOR COLD WATER

THE T10-SEAL CHAMBER CROMO 1ST STAGE is environmentally sealed, protecting it against icing in cold water and against contamination from particulate matter in silty conditions. When paired with the Master second stage, which includes an internal heat exchanger, this regulator is an excellent choice for divers exploring the most extreme cold water environments.

T10 SC MASTER

1ST STAGE T10 SC

2ND STAGE MASTER



TITANIUM COVER

PRODUCT	CODE
T10-SC MASTER - INT	HX830000
T10-SC MASTER - DIN 300	HX830100



T10-SC /MASTER INT



T10-SC /MASTER DIN

PVD COATING TREATMENT



CERTIFICATION EN250/2014 FOR COLD WATER

THE T10-SEAL CHAMBER 1ST STAGE is environmentally sealed, protecting it against icing in cold water and against contamination from particulate matter in silty conditions. When paired with the Master second stage, which includes an internal heat exchanger, this regulator is an excellent choice for divers exploring the most extreme cold water environments.

RESULTS: INHALE PRESSURE, EXHALE PRESSURE AND EXT WORK OF BREATHING

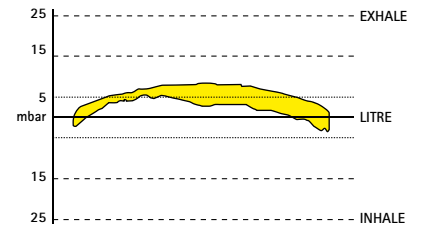

Perf. over 50 mt	
Perf. up to 50 mt	
Lightness	
Easiness of breathing	
Cold water perf. T10-SC	
	0 1 2 3 4 5 6 7 8 9 10
	Certification in accordance with EN250 standard

TOTAL WEIGHT

T10-SC/MASTER INT HOSE INCLUDED: 1.080 GR

T10-SC/MASTER DIN HOSE INCLUDED: 962 GR

TECHNICAL FEATURES 1ST STAGE

- Hyperbalanced diaphragm (Watertight chamber on T10-SC)
- 2 HP 7/16 UNF ports
- 4 MP 3/8 UNF ports
- Operating pressure: 300 bar (4350 psi) DIN Version, 232 bar (3365 psi) International version
- Calibration pressure: 10 bar
- Body coated with PVD process
- High-capacity conical filter in chemically nickel-plated spherical bronze
- Removable nozzle in AISI 316 steel
- Hyperbalancing system
- Anti-pressure drop pneumatic spring
- Stainless steel calibration spring with micropeening treatment
- Low-friction technopolymer slider shaft
- Body protection in polyurethane thermoplastic
- Quantity of air supplied: 4500 l/min
- Weight, INT version: 720 gr
- Weight, DIN version: 602 gr

TECHNICAL FEATURES 2ND STAGE

- Pneumatically balanced
- Adjustable Venturi
- Adjustable inhalation effort
- Patented elliptical diaphragm
- Patented low-friction lever
- Air delivery system without injector
- Adjuster knob coated with PVD process with dual OR
- Laser-etched titanium front piece
- Internal heat exchanger
- Cap opening with Cam-lock
- Noise-absorbing technopolymer body
- Removable technopolymer deflector
- Removable mechanics
- Weight without hose: 207 gr

COMBINATION PERFORMANCE

- Average Cracking effort 3.5 mbar
- Average breathing effort 0.6 J/l

JACKETED HOSE extremely light and flexible weight: 153 gr

CERTIFICATION EN250/2014



ELITE PACKAGING

T10 SC CROMO MASTER CROMO

1ST STAGE T10 SC CROMO

2ND STAGE MASTER CROMO



PRODUCT	CODE
T10-SC / MASTER CROMO - INT	HX840000
T10-SC / MASTER CROMO - DIN300	HX840100



T10-SC / MASTER CROMO INT



T10-SC / MASTER CROMO DIN



CERTIFICATION EN250/2014 FOR COLD WATER

THE T10-SEAL CHAMBER CROMO 1ST STAGE is environmentally sealed, protecting it against icing in cold water and against contamination from particulate matter in silty conditions. When paired with the Master second stage, which includes an internal heat exchanger, this regulator is an excellent choice for divers exploring the most extreme cold water environments.



RESULTS: INHALE PRESSURE, EXHALE PRESSURE AND EXT WORK OF BREATHING

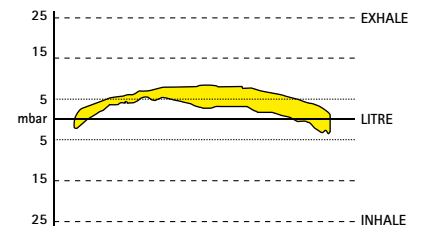

Perf. over 50 mt	
Perf. up to 50 mt	
Lightness	
Easiness of breathing	
Cold water perf. T10-SC	
	0 1 2 3 4 5 6 7 8 9 10
	Certification in accordance with EN250 standard

TOTAL WEIGHT

T10-SC / MASTER CROMO INT HOSE INCLUDED: 1.080 GR

T10-SC / MASTER CROMO DIN HOSE INCLUDED: 962 GR

Version technically identical to the T10 Master, but with a pleasing and durable satin chrome finish on the first stage and a brushed stainless steel cap on the second stage.

TECHNICAL FEATURES 1ST STAGE

- Hyperbalanced diaphragm (Watertight chamber on T10-SC)
- 2 HP 7/16 UNF ports
- 4 MP 3/8 UNF ports
- Operating pressure: 300 bar (4350 psi) DIN Version, 232 bar (3365 psi) International version
- Calibration pressure: 10 bar
- High-capacity conical filter in chemically nickel-plated spherical bronze
- Removable nozzle in AISI 316 steel
- Hyperbalancing system
- Anti-pressure drop pneumatic spring
- Stainless steel calibration spring with micropeening treatment
- Low-friction technopolymer slider shaft
- Body protection in polyurethane thermoplastic
- Quantity of air supplied: 4500 l/min
- Weight, INT version: 720 gr
- Weight, DIN version: 602 gr

TECHNICAL FEATURES 2ND STAGE

- Pneumatically balanced
- Adjustable Venturi
- Adjustable inhalation effort
- Patented elliptical diaphragm
- Patented low-friction lever
- Air delivery system without injector
- Adjuster knob coated with PVD process with dual OR
- Internal heat exchanger
- Cap opening with Cam-lock
- Noise-absorbing technopolymer body
- Removable technopolymer deflector
- Removable mechanics
- Weight without hose: 207 gr

COMBINATION PERFORMANCE

- Average Cracking effort 3.5 mbar
- Average breathing effort 0.6 J/l

JACKETED HOSE extremely light and flexible weight: 153 gr

CERTIFICATION EN250/2014



ELITE
PACKAGING

T10 SC CROMO COMPACT PRO

1ST STAGE T10 SC CROMO

2ND STAGE COMPACT PRO



NEW



STAINLESS STEEL COVER

RESULTS: INHALE PRESSURE, EXHALE PRESSURE AND EXT WORK OF BREATHING EXHALE

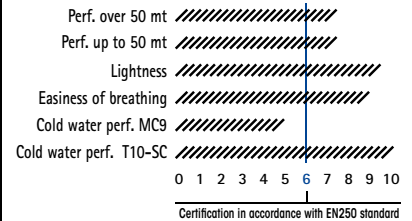
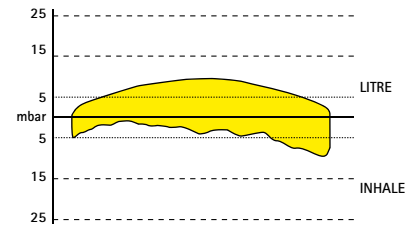

TOTAL WEIGHT

T10 SC CROMO INT/COMPACT PRO HOSE INCLUDED: 1.013 GR

T10 SC CROMO DIN/COMPACT PRO HOSE INCLUDED: 895 GR

TECHNICAL FEATURES 1ST STAGE

- Hyperbalanced diaphragm (Watertight chamber on T10-SC)
- 2 HP 7/16 UNF ports
- 4 MP 3/8 UNF ports
- Operating pressure: 300 bar (4350 psi) DIN Version, 232 bar (3365 psi) International version
- Calibration pressure: 10 bar
- High-capacity conical filter in chemically nickel-plated spherical bronze
- Removable nozzle in AISI 316 steel
- Hyperbalancing system
- Anti-pressure drop pneumatic spring
- Stainless steel calibration spring with micropeening treatment
- Low-friction technopolymer slider shaft
- Body protection in polyurethane thermoplastic
- Quantity of air supplied: 4500 l/min
- Weight, INT version: 720 gr
- Weight, DIN version: 602 gr

TECHNICAL FEATURES 2ND STAGE

- Downstream system
- Adjustable venturi effect
- Patented antifriction lever
- Thermoconductive technopolymer body
- Big purge button
- Anti-scratch surface
- Bayonet-type cap holder with security lock
- Stainless steel cover
- Removable exhaust tee without tools
- Weight without hose: 140 gr

COMBINATION PERFORMANCE

- Average Cracking effort 7.5 mbar
- Average breathing effort 1.2 J/l

JACKETED HOSE extremely light and flexible weight: 153 gr

CERTIFICATION EN250/2014

PRODUCT	CODE
T10 SC CROMO COMPACT PRO - INT	HX782500
T10 SC CROMO COMPACT PRO - DIN 300	HX782600



T10 SC CROMO COMPACT PRO - INT



T10 SC CROMO COMPACT PRO - DIN



CERTIFICATION EN250/2014 FOR COLD WATER

THE T10-SEAL CHAMBER 1ST STAGE is environmentally sealed, protecting it against icing in cold water and against contamination from particulate matter in silty conditions. When paired with the Master second stage, which includes an internal heat exchanger, this regulator is an excellent choice for divers exploring the most extreme cold water environments.



ELITE
PACKAGING

MC9 SC COMPACT PRO

1ST STAGE MC9 SC

2ND STAGE COMPACT PRO



STAINLESS STEEL COVER

In order to achieve extremely high performance in low temperature environments, the second stage in particular was designed with the special Thermoconductive Thermoplastic Neopolymer that has the capacity to transfer heat like a metal while preserving the design flexibility, chemical resistance, and physical and mechanical properties of a conventional thermoplastic. That is, it makes it possible to drastically reduce the weight while delivering heat conductivity on a par with metal cases. Thanks to this material and a specially conceived purge valve, it can pass all the tests for use in cold water with flying colors.

PRODUCT	CODE
MC9-SC COMPACT PRO - INT	HX782000
MC9-SC COMPACT PRO - DIN 300	HX782100



MC9-SC DIN/COMPACT PRO



MC9-SC INT/COMPACT PRO



RESULTS: INHALE PRESSURE, EXHALE PRESSURE AND EXT WORK OF BREATHING EXHALE

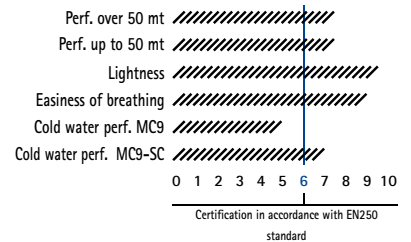
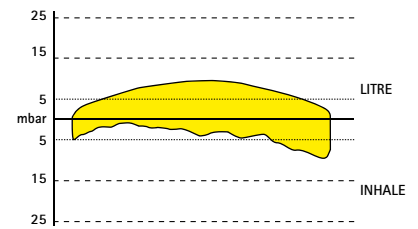

TOTAL WEIGHT

MC9-SC INT/COMPACT PRO HOSE INCLUDED: 943 GR

MC9-SC DIN/ COMPACT PRO HOSE INCLUDED: 803 GR

TECHNICAL FEATURES 1ST STAGE

- Balanced diaphragm (seal chamber for MC9SC)
- 2 outlets HP 7/16 UNF
- 4 outlets MP 3/8 UNF
- Service pressure: 300 bar (4350 psi) DIN version, 232 bar (3365 psi) Yoke version
- Calibration pressure: 10 Bar
- Brass body Electroless Nickel plated
- High capacity conical filter electroless nickel plated
- Aisi 316 removable nozzle
- Hyper-balancing
- Anti-pressure drop pneumatic spring
- Setting spring: stainless steel with micropeening treatment
- Replaceable cylinder with anti-friction and anti-corrosion properties
- Elastomer protector
- Flow rate: 4500 l/min
- Yoke version weight: 650 gr
- Din version weight: 510 gr

TECHNICAL FEATURES 2ND STAGE

- Downstream system
- Adjustable venturi effect
- Patented antifriction lever
- Thermoconductive technopolymer body
- Big purge button
- Anti-scratch surface
- Bayonet-type cap holder with security lock
- Stainless steel cover
- Removable exhaust tee without tools
- Weight without hose: 140 gr

COMBINATION PERFORMANCE

- Average Cracking effort 7.5 mbar
- Average breathing effort 1.2 J/l

JACKETED HOSE extremely light and flexible weight: 153 gr

CERTIFICATION EN250/2014



ELITE
PACKAGING



CERTIFICATION EN250/2014 FOR COLD WATER

THE MC9-SEAL CHAMBER 1ST STAGE is environmentally sealed, protecting it against icing in cold water and against contamination from particulate matter in silty conditions.

MC9 COMPACT

1ST STAGE MC9

2ND STAGE COMPACT



This premiere travel regulator packs maximum performance into minimum space. A true featherweight second stage, the Compact is built from lightweight techno-polymers to eliminate jaw fatigue. Easy to pack and easy to dive, the Compact includes dive/pre-dive Venturi switch for managing freeflow and maximizing performance at depth.

PRODUCT	CODE
MC9 COMPACT - INT	HX783051
MC9 COMPACT - DIN 300	HX784051



MC9 DIN/COMPACT



MC9 INT/COMPACT



RESULTS: INHALE PRESSURE, EXHALE PRESSURE AND EXT WORK OF BREATHING EXHALE

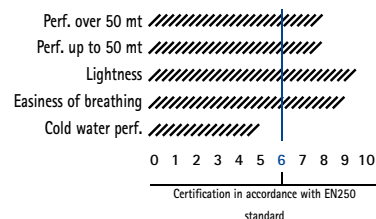
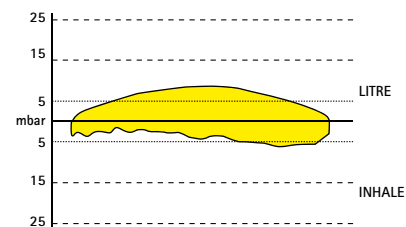

TOTAL WEIGHT

MC9 INT/COMPACT HOSE INCLUDED: 878 GR

MC9 DIN/COMPACT HOSE INCLUDED: 738 GR

TECHNICAL FEATURES 1ST STAGE

- Balanced diaphragm (seal chamber for MC9SC)
- 2 outlets HP 7/16 UNF
- 4 outlets MP 3/8 UNF
- Service pressure: 300 bar (4350 psi) DIN version, 232 bar (3365 psi) Yoke version
- Calibration pressure: 10 Bar
- Brass body Electroless Nickel plated
- High capacity conical filter electroless nickel plated
- Aisi 316 removable nozzle
- Hyper-balancing
- Anti-pressure drop pneumatic spring
- Setting spring: stainless steel with micropeening treatment
- Replaceable cylinder with anti-friction and anti-corrosion properties
- Elastomer protector
- Flow rate: 4500 l/min
- Yoke version weight: 590 gr
- Din version weight: 450 gr

TECHNICAL FEATURES 2ND STAGE

- Downstream system
- Adjustable venturi effect
- Patented antifriction lever
- Big purge button
- Anti-scratch surface
- Bayonet-type cap holder with security lock
- Removable exhaust tee without tools
- Weight without hose: 135 gr

COMBINATION PERFORMANCE

- Average Cracking effort 6 mbar
- Average breathing effort 1 J/l

JACKETED HOSE extremely light and flexible weight: 153 gr

CERTIFICATION EN250/2000



AC2 COMPACT

1ST STAGE AC2

2ND STAGE COMPACT



PRODUCT	CODE
AC2/COMPACT - INT	HX787051
AC2/COMPACT - DIN	HX788051

CRESSI 
dive center



PRODUCT	CODE
AC2/COMPACT DIVE CENTER EDITION - INT	JHX787151
AC2/COMPACT DIVE CENTER EDITION - DIN	JHX788151



TOTAL WEIGHT

AC2 INT/ COMPACT HOSE INCLUDED: 923 GR

AC2 DIN/ COMPACT HOSE INCLUDED: 783 GR

TECHNICAL FEATURES 1ST STAGE

- Piston design
- 1 outlets HP 7/16 UNF
- 4 outlets MP 3/8 UNF
- Service pressure: 300 bar (4350 psi) DIN version, 232 bar (3365 psi) Yoke version
- Calibration pressure: 9,5-10 Bar
- Brass body Electroless Nickel plated
- High capacity conical filter electroless nickel plated
- Aisi 316 long lasting piston
- Adjustable without take a part
- Stainless steel spring
- Flow rate: 2100 l/min
- Yoke version weight: 635 gr
- Din version weight: 495 gr

CERTIFICATION EN250/2000

EXTERIOR LP REGULATION
FACILITATES MANAGING ADJUSTMENTS
AND TECHNICAL MAINTENANCE



AC2 COMPACT + OCTOPUS COMPACT

ALSO
FOR
RENTALMADE IN
ITALY1ST STAGE AC2+ 2ND STAGE COMPACT

+ OCTOPUS COMPACT



PRODUCT	CODE
AC2 COMPACT + OCTOPUS COMPACT - INT	HY787051
AC2 COMPACT + OCTOPUS COMPACT - DIN	HY788051

AC2 / XS2

1ST STAGE AC2 2ND STAGE XS2

PRODUCT	CODE
AC2 XS2 - INT	HX780000



AC2 INT/XS2



TOTAL WEIGHT

AC2 INT/XS2 HOSE INCLUDED: 994 GR

TECHNICAL FEATURES 1ST STAGE

- Piston design
- 1 outlets HP 7/16 UNF
- 4 outlets MP 3/8 UNF
- Service pressure:
 - 232 bar (3365 psi) Yoke version
- Calibration pressure: 9,5-10 Bar
- Brass body Electroless Nickel plated
- High capacity conical filter electroless nickel plated
- Aisi 316 long lasting piston
- Adjustable without take a part
- Stainless steel spring
- Flow rate: 2100 l/min
- Yoke version weight: 635 gr

TECHNICAL FEATURES 2ND STAGE

- Downstream system
- Adjustable venturi effect
- Easy maintenance
- Weight without hose: 206 gr

JACKETED HOSE extremely light and flexible weight: 153 gr

CERTIFICATION EN250/2000

360 REGULATOR BAG



Comfortable padded bag to transport regulators and instruments.
Fitted with shoulder strap.



PRODUCT	CODE
360 REGULATOR BAG	UB940000

OCTOPUS MG BALANCED



Octopus regulator specially designed for the most demanding divers. Its main feature is a pneumatically balanced valve that minimises the breathing effort. The Venturi effect adjuster on the mouthpiece tube increases and decreases the air flow, doing away with the risks associated with free-flow. When scuba diving, breathing is natural and effortless. Thanks to its light weight and ergonomic design, this regulator is very handy and easy to use. Weight without the whip: 182 g.

TECHNICAL FEATURES

- Pneumatically balanced
- Venturi effect adjustment
- Patented elliptical membrane
- Patented low-friction lever
- Air delivery system without injector
- Internal heat exchange
- Cam-lock system to open the case
- Body in noise-absorbent technopolymer
- Removable technopolymer deflector
- Removable mechanical parts
- Weight without whip: 182 g

JACKETED HOSE

extremely light and flexible weight: 153 gr

CERTIFICATION Annex B EN 250:2014 for cold water

PRODUCT	CODE
OCTOPUS MG BALANCED	HX880000

OCTOPUS COMPACT PRO



TECHNICAL FEATURES

- Downstream system
- Adjustable venturi effect
- Patented antifriction lever
- Thermoconductive technopolymer body
- Big purge button
- Anti-scratch surface
- Bayonet-type cap holder with security lock
- Stainless steel cover
- Removable exhaust tee without tools
- Weight without hose: 140 gr

JACKETED HOSE extremely light and flexible weight: 153 gr

CERTIFICATION Annex B EN 250:2014 for cold water

PRODUCT	CODE
OCTOPUS COMPACT PRO	HX789500

OCTOPUS COMPACT



An ideal second stage for use as a safe second, the Compact delivers big-regulator performance in a small, easily stowed package. IT'S UNIQUE SHAPE MAKE IT EASY TO PURGE AND DEPLOY QUICKLY.

TECHNICAL FEATURES

- Downstream system
- Adjustable venturi effect
- Patented antifriction lever
- Big purge button
- Anti-scratch surface
- Bayonet-type cap holder with security lock
- Removable exhaust tee without tools
- Weight without hose :135 gr

JACKETED HOSE

extremely light and flexible weight: 153 gr

CERTIFICATION Annex B EN 250:2014_ A>10°C



PRODUCT	CODE
OCTOPUS COMPACT	HX789000
 OCTOPUS COMPACT DIVE CENTER EDITION	JHX789100

OCTOPUS XS



Proven and highly affordable, the XS Octopus is ideal for any diver looking for maximum value. Its low maintenance and ultra reliable design also make it a favorite among dive schools and rental centers.

TECHNICAL FEATURES

- Downstream system
- Adjustable venturi effect
- Easy maintenance
- Weight without hose: 206 gr

JACKETED HOSE

extremely light and flexible weight: 153 gr

CERTIFICATION Annex B EN 250:2014_ A>10°C

PRODUCT	CODE
OCTOPUS XS	HX770098

SERVICE AND REPAIR COMPLETE KIT

THE COMPLETE KIT TO SERVICE ALL THE CRESSI HARD GOODS!

CRESSI
dive center



REGULATORS TOOLS 1ST STAGE

- 1ST STAGE IP SETTING GAUGE
- + THREADED BAR TO TIGHTEN THE REGULATOR IN THE VICE
- + YOKE NUT REMOVING SOCKET AND WRENCH
- + ALLEN KEY 6 MM
- + EXTRACTION POINT TOOL
- + TOOL TO REMOVE O-RINGS
- + BIG COMPASS S.C. SPANNER
- + ANTIFREEZE/S.C. SPANNER
- + PUSH TOOL
- + OGIVAL TOOL O-RING BULLIT
- + PIN SPANNER
- + UNIVERSAL PUSH TOOL
- + AC2 IP ADJUSTING TOOL
- + REMOVING HP SEAT AC2

REGULATORS TOOLS 2ND STAGE

- 5,5 MM SOCKET DRIVER
- + SPRING PUSH TOOL
- + ALLEN KEY 4 MM
- + ALLEN KEY 6 MM
- + O-RING REMOVAL TOOL
- + 2ND STAGE INLINE ADJUSTER WITH IP GAUGE
- + 2ND STAGE SETTING GAUGE
- + SMALL COMPASS SPANNER
- + EXTRACTION PLIER

JACKETS TOOLS

- 12 MM SOCKET WRENCH
- + EXTRACTION POINT TOOL
- + COMPASS SPANNER
- + ALLEN KEY 2,5 MM
- + ALLEN KEY 6 MM
- + SCHRADER VALVE TOOL

MAIN TOOLS



PRODUCT	CODE
SERVICE AND REPAIR COMPLETE KIT	HZ830102
SPARE PARTS CATALOGUE	VPPART00



MAIN REGULATORS SPARE PARTS

FOR THE FULL LIST,
SEE OUR
SPARE PARTS
CATALOGUE



REGULATORS SPARE PARTS	CODE
MAINTENANCE KIT 1 ST STAGE INT/DIN T10-T10SC	HZ800045
MAINTENANCE KIT 1 ST STAGE INT/DIN MC9-MC9SC-MC5	HZ800047
MAINTENANCE KIT 1 ST STAGE AC10 INT	HZ735050
MAINTENANCE KIT 1 ST STAGE AC10 DIN 300	HZ735052
MAINTENANCE KIT 1 ST STAGE AC2 INT	HZ730150
MAINTENANCE KIT 1 ST STAGE AC2 DIN 300	HZ730149
MAINTENANCE KIT 2 ND STAGE COMPACT PRO-XS	HZ780060
MAINTENANCE KIT 2 ND STAGE MASTER/GALAXY/GALAXY R/ ELLIPSE BALANCED/ OCTOPUS MG BALANCED	HZ820080
MAINTENANCE KIT 2 ND STAGE ELLIPSE TITANIUM/ STEEL/BLACK/OCTOPUS	HZ810067
MAINTENANCE KIT 2 ND STAGE XS/OCTOPUS	HZ790090
LP BLACK HOSE 80 CM	HZ730222
LP YELLOW HOSE 100 CM	HZ730225
COVER COMPACT GREY	HZ780067
COVER COMPACT WHITE	HZ780064
COVER COMPACT PINK	HZ780065
COVER COMPACT LILAC	HZ780049
COVER COMPACT YELLOW	HZ780066

REGULATOR TOOLS	CODE
1 ST STAGE SETTING PRESSURE GAUGE	HZ710010
THREADED BAR TO TIGHTEN THE REGULATOR IN THE VICE	HZ709008
BIG COMPASS MC9 SC SPANNER	HZ739003

	CODE
ELITE PROTECTIVE CASE	HZ700000

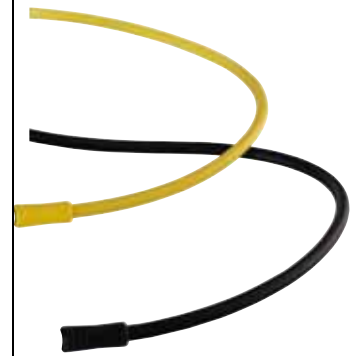

CRESSI

B . C . D . ' S

BUYER'S GUIDE 2019

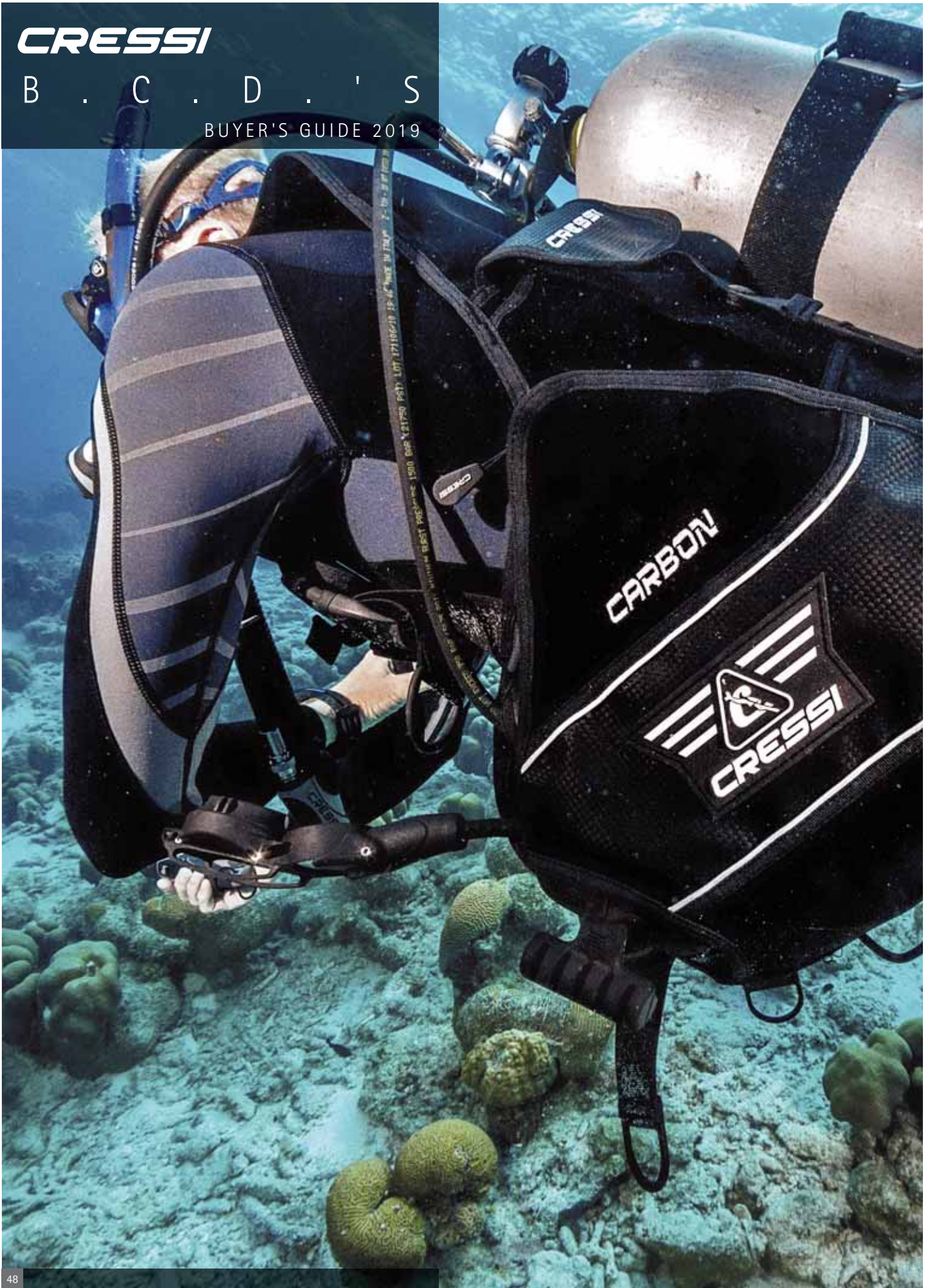

COMMANDER EVOLUTION



WEIGHT	XS	S	M	L	XL
KG	3.05	3.10	3.20	3.30	3.40
LBS	6,70	6,83	7,05	7,27	7,50

TECHNICAL FEATURES

- Development of rear-mounted air cell
- Air cell material: 420 denier nylon
- Integrated Cressi Flat-lock Aid weight System
- 2 rear ballast pouches
- 3 pressure relief valves
- Four 50mm aluminium D-rings on the shoulder straps
- Four 25 mm stainless steel D-rings (2 on the pockets and 2 on the lower part of the harness)
- Ultralight rigid back plate with carrying handle.
- Next generation anatomical inflator with hose retainer.
- Multipurpose zip pockets
- 50 mm quick-release buckled shoulder straps.



HIGH LIFT CAPACITY

The Commander Evolution Jacket is an impressively light high-buoyancy rear-mounted BC, anatomically designed for maximum comfort and wearability. Its main features are its detachable harness and air cell. The rear-mounted air cell interferes neither with the main underwater component nor the adjustment straps, not even when it is inflated to the maximum. This means extra freedom of movement and buoyancy for the diver. The special air cell compression strap guarantees extra quick deflation and volume control. The ultralight rigid back plate with its integrated carrying handle ensures optimal stability. Its integrated Cressi Flat-Lock-Aid weight system makes it extra easy to release the pockets and rear ballast bags (attached to the tank-block band). Accessories include four 50mm shoulder aluminium D-rings and four 25mm aluminium D-rings (of which two on the pockets and two on the lower part of the harness). There are 3 pressure relief valves: one on the upper part of the hose, one reel-operated valve on the right-hand side of the shoulder and a third on the lower right-hand side of the air cell.

PRODUCT	SIZE	CODE
COMMANDER EVOLUTION	XS	IC771000
COMMANDER EVOLUTION	S	IC771001
COMMANDER EVOLUTION	M	IC771002
COMMANDER EVOLUTION	L	IC771003
COMMANDER EVOLUTION	XL	IC771004
FLAT LOCK AID SYSTEM WEIGHT POCKET		IZ750094

NEW

BUOYANCY	XS	S	M	L	XL
NEWTON	130	130	190	225	225
KG	13.3	13.3	19.4	23.0	23.0
POUNDS	29.2	29.2	42.7	50.6	50.6

ADJUSTABLE WAIST BAND



REAR ATTACHMENT HARNESS FOR MAXIMUM STABILITY



BLACK ALU D-RINGS



50 MM BUCKLES



ZIPPERED POCKETS



BACK WEIGHT POCKETS



FLAT LOCK SYSTEM

CARBON

WEIGHT	XS	S	M	L	XL
KG	3.00	3.10	3.20	3.30	3.40
LBS	6.61	6.83	7.05	7.27	7.50

TECHNICAL FEATURES

- 420 denier nylon air cell
- Ultralight, rigid back plate with carrying handle.
- Next generation ergonomic inflator with hose retainer.
- 2 multipurpose zip pockets
- Rear ballast pockets.
- Shoulder straps with 50 mm quick-release buckles.
- 3 pressure relief valves



PRODUCT	SIZE	CODE
CARBON	XS	IC741300
CARBON	S	IC741301
CARBON	M	IC741302
CARBON	L	IC741303
CARBON	XL	IC741304
FLAT LOCK AID SYSTEM WEIGHT POCKET		IZ750094

BUOYANCY	XS	S	M	L	XL
NEWTON	80	90	130	160	190
KG	8.2	9.2	13.3	16.3	19.4
POUNDS	18.0	20.2	29.2	36.0	42.7



BLACK
ALU D-RINGS



50 MM
BUCKLES



ZIPPED
POCKETS



BACK WEIGHT
POCKETS



FLAT LOCK
SYSTEM

The Carbon jacket is a classically built BCD. Its intermediate buoyancy level makes it extremely versatile and suitable in any situation. The ergonomic design of the inflator mechanism makes inflating and deflating extra easy and the practical hose retainer keeps it compact and safe. Its special ultralight back plate maintains the tank body compact which significantly improves both underwater and surface buoyancy and comfort.

SCORPION

TECHNICAL FEATURES

- Development of rear-mounted air cell
- Air cell material: 420 denier nylon
- Integrated Cressi Flat-Lock-Aid Weight System on a back vertical position
- 3 pressure relief valves: one on the upper part of the hose, one reel-operated valve on the right-hand side of the shoulder and a third on the lower right-hand side of the air cell
- Two 50 mm aluminium D-rings on the shoulder straps
- Two 25 mm aluminium D-rings on the pockets
- Ultralight semi-rigid harness
- Next generation anatomical inflator with hose retainer
- Multipurpose zip pockets with weight pockets inside
- 40 mm quick-release buckled shoulder straps
- Side adjustable lumbar flaps



VERTICAL FLAT LOCK SYSTEM



The Scorpion Jacket is an impressively light high-buoyancy rear-mounted BC, anatomically designed for maximum comfort and wearability. Its main features are its detachable harness and air cell. The rear-mounted air cell interferes neither with the main underwater component nor with the adjustment straps, not even when it is inflated to the maximum: this means extra freedom of movement and buoyancy for the diver. The special air cell compression strap guarantees extra quick deflation and volume control. The ultralight semi-rigid harness ensures optimal stability and high comfort with its air-net fabric. Its integrated Cressi Flat-Lock-Aid Weight System makes extra easy to release the pockets.

PRODUCT	SIZE	CODE
SCORPION	XS	IC770000
SCORPION	S	IC770001
SCORPION	M	IC770002
SCORPION	L	IC770003
SCORPION	XL	IC770004
FLAT LOCK AID SYSTEM WEIGHT POCKET		IZ750094

NEW

BUOYANCY	XS	S	M	L	XL
NEWTON	130	130	160	160	160
KG	13.3	13.3	16.3	16.3	16.3
POUNDS	29.2	29.2	36.0	36.0	36.0

ULTRALIGHT SEMI-RIGID HARNESS



REAR ATTACHMENT HARNESS FOR MAXIMUM STABILITY



BLACK ALU D-RINGS



40 MM BUCKLES

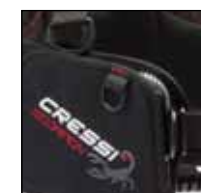

LARGE ZIPPED POCKETS

AQUARIDE

WEIGHT	XS	S	M	L	XL
KG	3.00	3.10	3.20	3.30	3.40
LBS	6.61	6.83	7.05	7.27	7.50



BUOYANCY	XS	S	M	L	XL
NEWTON	80	90	130	160	190
KG	8.2	9.2	13.3	16.3	19.4
POUNDS	18.0	20.2	29.2	36.0	42.7



STEEL
D-RINGS



50 MM
BUCKLES



ZIPPED
POCKETS



BACK WEIGHT
POCKETS



FLAT LOCK
SYSTEM

PRODUCT	SIZE	CODE
AQUARIDE	XS	IC740700
AQUARIDE	S	IC740701
AQUARIDE	M	IC740702
AQUARIDE	L	IC740703
AQUARIDE	XL	IC740704
FLAT LOCK AID SYSTEM WEIGHT POCKET		IZ750094

Aquaride is a semi-classic structured BC with a special feature: it has adjustable shoulder straps that aren't restricted by the air cell, improving the grip on the tank and improving comfort. Thanks to their anatomical, preformed profile, they are much easier to put on and make resting the tank more comfortable on the shoulders. The BC features the Flat type Lock Aid System of integrated weight. It is very effective and comfortable thanks to its extremely flat profile and the easy and intuitive arrangement of the pockets. Finally, the anatomical control has a hose retainer, making all inflation and deflation operations very easy and intuitive.

TECHNICAL FEATURES

- Adjustable shoulder straps
- 420 Denari Nylon bag.
- Flat system Lock Aid System integrated weight.
- Superlight rigid backpack with handle.
- Next generation anatomical inflator with hose retainer.
- Expandable sundries pocket with zip closure.
- Quick-attach rear weight pockets (capacity 2 kg).
- 3 purge and overpressure valves.

R 1

WEIGHT	XS	S	M	L	XL
KG	2.85	2.90	3.00	3.10	3.20
LBS	6.28	6.39	6.61	6.83	7.05



BUOYANCY	XS	S	M	L	XL
NEWTON	75	90	105	150	160
KG	7.7	9.2	10.7	15.3	16.3
POUNDS	16.9	20.2	23.6	33.7	36.0

STEEL
D-RINGS50 MM
BUCKLESZIPPED
POCKETSFLAT LOCK
SYSTEM

Rugged BCD with integrated movable weight pockets.

TECHNICAL FEATURES

- New "flat" Lock Aid System
- Two large sundries pockets
- Rigid back
- 3 release valves
- Sizes XS - S - M - L - XL

PRODUCT	SIZE	CODE
R1	XS	IC730000
R1	S	IC730001
R1	M	IC730002
R1	L	IC730003
R1	XL	IC730004
FLAT LOCK AID SYSTEM WEIGHT POCKET		IZ750094

AQUAPRO



WEIGHT	XS	S	M	L	XL
KG	2.60	2.70	2.90	2.90	2.95
LBS	5.73	5.95	6.39	6.39	6.50



BUOYANCY	XS	S	M	L	XL
NEWTON	75	90	105	150	160
KG	7.7	9.2	10.7	15.3	16.3
POUNDS	16.9	20.2	23.6	33.7	36.0



STEEL
D-RINGS



50 MM
BUCKLES



ZIPPED
POCKETS



FIXED
GRAVITY
POCKET
SYSTEM

This moderately priced BC offers exceptional value and a wide range of capabilities. The jacket-style air cell is stable in all diving conditions, especially at the surface. Low-profile "gravity" integrated weight pockets are easy to load and release, and the rigid backpack and updated harness provide good load distribution in and out of the water.

TECHNICAL FEATURES

- Durable 420 Denier nylon construction
- Gravity weight pockets use large Fastex buckles.
- Rigid, padded backpack with carry handle
- Quick-release shoulder buckles for fast donning and doffing
- Special harness design eliminates squeeze when BC is fully inflated
- Three exhaust valves for buoyancy adjustment in any position
- Two zippered cargo pockets
- 2 stainless D-rings
- 2 technopolymer D-rings
- 2 spring-clip holding rings
- Streamlined power inflator
- Sizes Adult XS - S - M - L - XL

PRODUCT	SIZE	CODE
AQUAPRO	XS	IC721200
AQUAPRO	S	IC721201
AQUAPRO	M	IC721202
AQUAPRO	L	IC721203
AQUAPRO	XL	IC721204

TRAVELIGHT



WEIGHT	XS	S	M	L	XL
KG	2.40	2.40	2.50	2.50	2.60
LBS	5.29	5.29	5.51	5.51	5.73



MAN



LADY

PRODUCT	SIZE	CODE
TRAVELIGHT MAN BLUE	XS	IC740600
TRAVELIGHT MAN BLUE	S	IC740601
TRAVELIGHT MAN BLUE	M	IC740602
TRAVELIGHT MAN BLUE	L	IC740603
TRAVELIGHT MAN BLUE	XL	IC740604
TRAVELIGHT LADY PINK	XS	IC740620
TRAVELIGHT LADY PINK	S	IC740621
TRAVELIGHT LADY PINK	M	IC740622
FLAT LOCK AID SYSTEM WEIGHT POCKET		IZ750094

BUOYANCY	XS	S	M	L	XL
NEWTON	60	80	90	130	160
KG	6.1	8.2	9.2	13.3	16.3
POUNDS	13.5	18.0	20.2	29.2	36.0



LIGHT ALLOY D-RINGS



40 MM BUCKLES



ZIPPED POCKETS



FAST FOLDING SYSTEM



FLAT LOCK SYSTEM

TECHNICAL FEATURES

- 210 denier nylon material, rubbery material (rear)
- 2 zip up pockets for accessories
- 2 rear weight carrying pockets
- Soft, padded back, with double strap for fixing the tank
- D-rings and rings in light alloy.
- Three discharge and pressure valves
- Rear release valve with control brought to the front
- FAST system for folding and compacting the BC
- Velcro strap, closed in a lower zip up pocket for packing the BC.

PATROL

WEIGHT	XS	S	M	L	XL
KG	2.60	2.60	2.75	2.90	2.90
LBS	5.73	5.73	6.06	6.39	6.39



BUOYANCY	XS	S	M	L	XL
NEWTON	130	130	190	225	225
KG	13.3	13.3	19.4	23.0	23.0
POUNDS	29.2	29.2	42.7	50.6	50.6



SHOULDER HARNES FULLY ADJUSTABLE



40 MM BUCKLES



WAIST HARNES FULLY ADJUSTABLE



HIDEAWAY POCKET



FLAT LOCK SYSTEM

PRODUCT	SIZE	CODE
PATROL	XS	IC741600
PATROL	S	IC741601
PATROL	M	IC741602
PATROL	L	IC741603
PATROL	XL	IC741604
FLAT LOCK AID SYSTEM WEIGHT POCKET		IZ750094
BACK WEIGHT POCKETS		IC760099

The Patrol BC is an impressively light weight, rear inflation BC that is anatomically designed for maximum comfort and durability. The special air cell compression strap guarantees extra quick deflation and volume control. The ultralight rigid back plate with its integrated carrying handle ensures optimal stability. The Patrol also features Cressi's Flat-Lock-Aid integrated weight system that makes it easy to release the pockets. There are 3 pressure relief valves: one on the upper part of the hose, one valve on the right-hand side of the shoulder and a third on the lower right-hand side of the air cell. The Patrol also features plastic d-rings to help reduce weight and the shoulder and waist harness are fully adjustable to one full size up or down from the stated size.



BACK WEIGHT POCKETS OPTIONAL

START PRO



WEIGHT	XS	S	M	L	XL
KG	2.45	2.50	2.70	2.80	2.85
LBS	5.40	5.51	5.95	6.17	6.28



HIGH LIFT CAPACITY

BUOYANCY	XS	S	M	L	XL
NEWTON	130	140	150	170	200
KG	13.3	14.3	15.3	17.3	20.4
POUNDS	29.2	31.5	33.7	38.2	45.0



ENGINEERING PLASTIC D-RINGS



50 MM BUCKLES



ZIPPED POCKETS



OCTOPUS AND GAUGE HOLDER



FIXED GRAVITY POCKET SYSTEM

PRODUCT	SIZE	CODE
START PRO	XXS - KID	IC721905
START PRO	XS	IC721900
START PRO	S	IC721901
START PRO	M	IC721902
START PRO	L	IC721903
START PRO	XL	IC721904

Its high level of buoyancy (notably in the smaller models) makes this jacket ideal for beginners, diving schools or renting.

TECHNICAL FEATURES

- 500 denier cordura (exterior) and 420 denier nylon (interior)
- External ballast-carrying pockets with quick-release safety buckle
- 2 very big multipurpose zip pockets
- ultralight rigid backplate with carrying handle.
- 3 pressure relief valves.
- Four 40 mm engineering plastic D-rings (2 on the shoulder straps and 2 on the lower part of the air cell.
- Two 25mm engineering plastic D-rings on the pockets.
- Size indicated clearly on the shoulder strap.
- Shoulder straps with 50mm buckles.

START

ALSO FOR RENTAL

WEIGHT	XS	S	M	L	XL
KG	2.40	2.50	2.60	2.70	2.80
LBS	5.29	5.51	5.73	5.95	6.17

BUOYANCY	XS	S	M	L	XL
NEWTON	130	140	150	170	200
KG	13.3	14.3	15.3	17.3	20.4
POUNDS	29.2	31.5	33.7	38.2	45.0



↑
HIGH LIFT CAPACITY



OCTOPUS HOLDER



GAUGE HOLDER

PRODUCT	SIZE	CODE
START	XS	IC721700
START	S	IC721701
START	M	IC721702
START	L	IC721703
START	XL	IC721704

SOLID

WEIGHT	XS	S	M	L	XL
KG	2.40	2.50	2.60	2.70	2.80
LBS	5.29	5.51	5.73	5.95	6.17

Jacket Solid: Good buoyancy, ideal for scuba diving schools and equipment rental centres. It features a coloured reinforcement band in the upper part of the back, at neck level, to enhance visibility in the water and protect the jacket from the abrasive action of the first stage. The sternal attachment is closed by a buckle which also serves as a safety whistle.

Technical data:

- 500D Cordura (exterior part) and 420D Nylon (interior)
- 2 large accessory holder zip-up pockets
- Light-weight, rigid backplate with carry handle.
- 3 overpressure dump valves
- 2 25 mm technopolymer D-rings on the pockets
- Size shown on shoulder straps
- 50 mm shoulder straps with buckles.



↑
HIGH LIFT CAPACITY

PRODUCT	SIZE	CODE
SOLID DIVE CENTER EDITION	XXS - KID	JIC741705
SOLID DIVE CENTER EDITION	XS	JIC741700
SOLID DIVE CENTER EDITION	S	JIC741701
SOLID DIVE CENTER EDITION	M	JIC741702
SOLID DIVE CENTER EDITION	L	JIC741703
SOLID DIVE CENTER EDITION	XL	JIC741704

BUOYANCY	XS	S	M	L	XL
NEWTON	130	140	150	170	200
KG	13.3	14.3	15.3	17.3	20.4
POUNDS	29.2	31.5	33.7	38.2	45.0



**HIGH
VISIBILITY
SAFETY
BACK PAD**



**ULTRA
RESISTANT
MATERIAL**



**50 MM
BUCKLES**



**ZIPPED
POCKETS**



**OCTOPUS
& GAUGE
HOLDER**



START PRO SCUBA SET



PRODUCT	SIZE	CODE
START PRO SCUBA SET - INT	XS	IY721800
START PRO SCUBA SET - INT	S	IY721801
START PRO SCUBA SET - INT	M	IY721802
START PRO SCUBA SET - INT	L	IY721803
START PRO SCUBA SET - INT	XL	IY721804

PRODUCT	SIZE	CODE
START PRO SCUBA SET - DIN	XS	IY721810
START PRO SCUBA SET - DIN	S	IY721811
START PRO SCUBA SET - DIN	M	IY721812
START PRO SCUBA SET - DIN	L	IY721813
START PRO SCUBA SET - DIN	XL	IY721814

NEW

A COMPLETE SCUBA SET
INCLUDING:

- B.C.D. START PRO
- + 1ST STAGE MC9
- + 2ND STAGE COMPACT
- + OCTOPUS COMPACT
- + CONSOLE 2



START SCUBA SET



A COMPLETE SCUBA SET INCLUDING:

- B.C.D. START
- + 1ST STAGE AC2
- + 2ND STAGE COMPACT
- + OCTOPUS COMPACT
- + PRESSURE GAUGE



PRODUCT	SIZE	CODE
START SCUBA SET - INT	XS	IY721700
START SCUBA SET - INT	S	IY721701
START SCUBA SET - INT	M	IY721702
START SCUBA SET - INT	L	IY721703
START SCUBA SET - INT	XL	IY721704

PRODUCT	SIZE	CODE
START SCUBA SET - DIN	XS	IY721710
START SCUBA SET - DIN	S	IY721711
START SCUBA SET - DIN	M	IY721712
START SCUBA SET - DIN	L	IY721713
START SCUBA SET - DIN	XL	IY721714

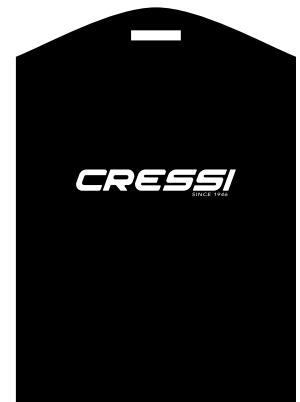

MAIN B.C.D.'S SPARE PARTS

FOR THE FULL LIST,
SEE OUR
SPARE PARTS
CATALOGUE



B.C.D.'S SPARE PARTS	CODE
BY-PASS INFLATOR COMPLETE (NM)	IZ750244
COMPLETE INFLATOR B.C.'D (NM)	IZ750243
CONVOLUTED HOSE B.C.'D	IZ750272
CAM BAND TRIM WEIGHT POCKETS	IC760099
LOCK AID SYSTEM (S300 SIZE M/L/XL)	IZ750097
LOCK AID SYSTEM (S300 SIZE XS-S TRAVELIGHT/AIRTRAVEL)	IZ750096
2012 FLAT LOCK AID SYSTEM WEIGHT POCKETS (NEW AQUARIDE/NEW BACK JAC)	IZ750094
WEIGHT POCKETS S2011	IZ750095



CRESSI B.C.D.'S TECHNICAL FEATURES



	COMMANDER EVO	CARBON	SCORPION	AQUARIDE	PATROL	TRAVELIGHT	R1	AQUAPRO	START PRO	START	SOLID
TYPE OF AIR CELL-MATERIAL	BACK CELL-NYLON 420 DENARI	STANDARD -NYLON 420 DENARI	BACK CELL-NYLON 420 DENARI	STANDARD -NYLON 420 DENARI	BACK CELL-NYLON 420 DENARI	STANDARD -NYLON 210 DENARI	STANDARD -NYLON 420 DENARI	STANDARD -NYLON 420 DENARI	STANDARD -CORDURA 500 DENARI	STANDARD -CORDURA 500 DENARI	STANDARD -CORDURA 500 DENARI
BUOYANCY IN NEWTON											
XXS									70		70
XS	130	80	130	80	130	60	75	75	130	130	130
S	130	90	130	90	130	60	90	90	140	140	140
M	190	130	160	130	190	90	110	105	150	150	150
L	225	160	160	160	225	130	160	150	170	170	170
XL	225	190	160	190	225	160	160	160	200	200	200
TYPE OF BACKPLATE/ CYLINDER FIXING	RIGID/SINGLE STRAP	RIGID/SINGLE STRAP	SOFT/DOUBLE STRAP	RIGID/SINGLE STRAP	RIGID/SINGLE STRAP	SOFT/DOUBLE STRAP	RIGID/SINGLE STRAP	RIGID/SINGLE STRAP	RIGID/SINGLE STRAP	RIGID/SINGLE STRAP	RIGID/SINGLE STRAP
COMPATIBLE CYLINDERS LITRES-DIAMETER mm	MONO 10/12/15/18-171/203/216	MONO 10/12/15/18-171/203/216	MONO 10/12/15/18-171/203/216	MONO 10/12/15/18-171/203/216	MONO 10/12/15/18-171/203/216	MONO 10/12/15/18-171/203/216	MONO 10/12/15/18-171/203/216	MONO 10/12/15/18-171/203/216	MONO 10/12/15/18-171/203/216	MONO 10/12/15/18-171/203/216	MONO 10/12/15/18-171/203/216
INTEGRATED WEIGHT POCKETS - MAX kg FOR POCKET	FLAT LOCK AID - 4.5+4.5	FLAT LOCK AID - 4.5+4.5	VERTICAL FLAT LOCK AID - 4.5+4.5	FLAT LOCK AID - 4.5+4.5	FLAT LOCK AID - 4.5+4.5	FLAT LOCK AID - 4.5+4.5	FLAT LOCK AID - 4.5+4.5	FIXED GRAVITY POCKET - 2+2 (XXS, XS, S) 3+3 (M, L, XL)	FIXED GRAVITY POCKET - 2+2 (XXS, XS, S) 3+3 (M, L, XL)	NO	NO
ABDOMINAL ADJUSTMENT	ADJUSTABLE WAIST BAND + BUCKLE	STANDARD WAIST BAND + BUCKLE	REVERSE BUCKLE	STANDARD WAIST BAND + BUCKLE	BUCKLE + LAS (LENGHT ADJ. SYSTEM)	STANDARD WAIST BAND + BUCKLE	STANDARD WAIST BAND + BUCKLE	STANDARD WAIST BAND + BUCKLE	STANDARD WAIST BAND + BUCKLE	STANDARD WAIST BAND + BUCKLE	STANDARD WAIST BAND + BUCKLE
STERNAL ADJUSTMENT	MOVABLE	FIXED	MOVABLE	FIXED	FIXED	FIXED	FIXED	FIXED	FIXED	FIXED	FIXED
SHOULDER STRAP ADJUSTMENT	STANDARD	STANDARD	STANDARD	STANDARD	STANDARD+LAS	STANDARD	STANDARD	STANDARD	STANDARD	STANDARD	STANDARD
QUICK DUMP AND OVER-PRESSURE VALVES											
N°	DISCHARGE KNOB POSITION 2/3	At the back, lower right area At the front, upper right Area 2/3	At the back, lower right area At the front, upper right Area 2/3	At the back, lower right area At the front, upper right Area 2/3	At the back, lower right area At the front, upper right Area 2/3	At the back, lower right area At the front, upper right Area 2/3	At the back, lower right area At the front, upper right Area 2/3	At the back, lower right area At the front, upper right Area 2/3	At the back, lower right area At the front, upper right Area 2/3	At the back, lower right area At the front, upper right Area 2/3	At the back, lower right area At the front, upper right Area 2/3
TOTAL DUMP VALVES	4	4	4	4	4	4	4	4	4	4	4
N° CHARGE VALVES	2	2	2	2	2	2	2	2	2	2	2
TYPE OF CONTROL UNIT	FLAT	FLAT	FLAT	FLAT	FLAT	FLAT	FLAT	FLAT	FLAT	FLAT	FLAT
N° OF POCKETS	2	2	2	2	1	2	2	2	2	2	2
N° OF BACK POCKETS	2	2		2		2					
N° OF "D" RINGS	8	8	6	8	6	6	6	6	6	4	4
B.C.D. WEIGHT TOTAL BALLAST THAT CAN BE USED (kg)											
XXS									2.3 - 4		
XS	3.05 - 14	3.0 - 14	N.A. - 9	3.0 - 14	2.6 - 9	2.4 - 14	2.85 - 9	2.6 - 4	2.45 - 4	2.4 - NO	2.4 - NO
S	3.1 - 14	3.1 - 14	N.A. - 9	3.1 - 14	2.6 - 9	2.4 - 14	2.9 - 9	2.7 - 4	2.5 - 4	2.5 - NO	2.5 - NO
M	3.2 - 14	3.2 - 14	N.A. - 9	3.2 - 14	2.75 - 9	2.5 - 14	3.0 - 9	2.9 - 6	2.7 - 6	2.6 - NO	2.6 - NO
L	3.3 - 14	3.3 - 14	N.A. - 9	3.3 - 14	2.9 - 9	2.5 - 14	3.1 - 9	2.9 - 6	2.8 - 6	2.7 - NO	2.7 - NO
XL	3.4 - 14	3.4 - 14	N.A. - 9	3.4 - 14	2.9 - 9	2.6 - 14	3.2 - 9	2.93 - 6	2.85 - 6	2.8 - NO	2.8 - NO
WEARABILITY: CHEST (cm) - WAIST (cm) - WEIGHT (kg)											
XXS									70/85 70/80 48/60		70/85 70/80 48/60
XS	80/90 75/90 55/65	80/90 75/90 55/65	80/90 75/90 55/65	80/90 75/90 55/65	80/90 75/90 55/65	80/90 75/90 55/65	80/90 75/90 55/65	80/90 75/90 55/65	80/90 75/90 55/65	80/90 75/90 55/65	80/90 75/90 55/65
S	90/100 85/95 63/78	90/100 85/95 63/78	90/100 85/95 63/78	90/100 85/95 63/78	90/100 85/95 63/78	90/100 85/95 63/78	90/100 85/95 63/78	90/100 85/95 63/78	90/100 85/95 63/78	90/100 85/95 63/78	90/100 85/95 63/78
M	100/110 95/105 75/85	100/110 95/105 75/85	100/110 95/105 75/85	100/110 95/105 75/85	100/110 95/105 75/85	100/110 95/105 75/85	100/110 95/105 75/85	100/110 95/105 75/85	100/110 95/105 75/85	100/110 95/105 75/85	100/110 95/105 75/85
L	105/115 100/110 80/100	105/115 100/110 80/100	105/115 100/110 80/100	105/115 100/110 80/100	105/115 100/110 80/100	105/115 100/110 80/100	105/115 100/110 80/100	105/115 100/110 80/100	105/115 100/110 80/100	105/115 100/110 80/100	105/115 100/110 80/100
XL	115/125 110/120 110/120	115/125 110/120 110/120	115/125 110/120 110/120	115/125 110/120 110/120	115/125 110/120 110/120	115/125 110/120 110/120	115/125 110/120 110/120	115/125 110/120 110/120	115/125 110/120 110/120	115/125 110/120 110/120	115/125 110/120 110/120

CRESSI

DIVE SUITS

BUYER'S GUIDE 2019



DESERT DRY SUIT WITH LIQUID SEAL TECHNOLOGY



- THICKNESS 4 MM HIGH DENSITY
- METALLIC BACK ZIP
- HIGH STRETCH SPANFLEX MATERIAL



A LAYER OF POLYMER IS SPREAD ALONG THE SEAMS TO PROTECT AND SEAL THEM, THEREBY INCREASING THE RESISTANCE TO WEAR, THE LIFETIME OF THE SUIT, AND ITS INSULATING POWER.



SMOOTH SKIN NEOPRENE
(neck, wrists)



ULTRA DURABLE
X-DIAMOND PAD
(shoulders, chest, knees)



HIGH VOLUME
POCKET D-RING
AND HOOD HOLDER



SOFT NEOPRENE SOCKS



Comfortable and resistant thanks to its 4mm thick High-Density pre-compressed neoprene dry suit and Liquid Seal lining are covered with a special layer of elastomer so as to simultaneously create an impermeable obstacle for the water and increased resistance at the joints. On the inside, an additional sealing strip guarantees total waterproof-ability. This double sealing system has been carefully designed to meet the needs of the most discerning and seasoned divers that often require their dry suits to be able to adapt to extreme working or weather conditions. The special Spanflex material has also been used in the outer part so as to increase elasticity and abrasion resistance. The cuffs are made of smooth 3,5 mm-thick neoprene on the inside in order to improve sealability and from Ultraspan on the outside in order to improve elasticity. The collar is made of the same materials but with 2,5mm-thick neoprene for more comfort and breathability when turned-up. The shoulder neck and knee lines are reinforced with a special anti-abrasion X-Diamond Pad lining. The suit comes with a practical multipurpose pocket placed on the right leg as well as a comfortable hood.

TECHNICAL FEATURES

- 4 mm-thick High-Density pre-compressed neoprene.
- Soft neoprene socks.
- Internal suspender system.
- Fly with concealed zip.
- Heavy duty kneepads
- Side action rotating inflation valve.
- Adjustable discharge relief valve.



ALL-IN-ONE MAN 4mm H-D

SIZE	CODE
S/2	LQ401002
M/3	LQ401003
L/4	LQ401004
XL/5	LQ401005
XXL/6	LQ401006
XXXL/7	LQ401007

ALL-IN-ONE LADY 4mm H-D

SIZE	CODE
XS/1	LQ401101
S/2	LQ401102
M/3	LQ401103
L/4	LQ401104
XL/5	LQ401105

UNISEX UNDERSUIT

SIZE	CODE
XS/1	LW475002
S/2	LW475003
M/3	LW475004
L/4	LW475005
XL/5	LW475006
XXL/6	LW475007

HOOD INCLUDED



DRY SUIT OPTIONAL ACCESSORIES

UNDERSUIT



LUX BOOTS
5 mm page 87



COMFORT WETSUIT

7mm

- BACK ZIP
- 100% ELASTIC SPAN
- ELASTIC PLUSH INSIDE



PREMIUM
ULTRASTRETCH
NEOPRENE

10-18° C | CE Certification
50-64° F | EN 14225-1: B

One piece cold water wetsuit made of 7 mm neoprene, with an outer layer in Elastic-Span and inner lining in Elastic-Plush. These materials make the suit warm and extremely elastic, making it very easy to put on. A YKK zipper (ensuring optimal quality) runs vertically on the back. The knees are reinforced with special protective patches. A very handy pocket on the right leg has two compartments and a useful D-ring. Double sleeves and zippers on wrists and ankles. A special sealing system on the collar minimises water infiltration.

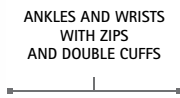
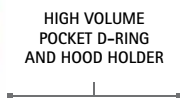
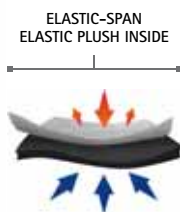

ANTI-SEEPAGE COLLAR

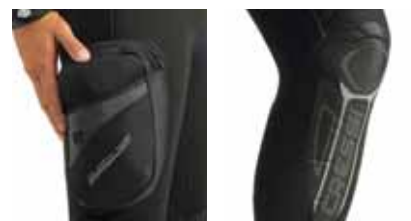

ALL-IN-ONE MAN - 7mm

SIZE	CODE
S/2	LS507202
M/3	LS507203
L/4	LS507204
XL/5	LS507205
XXL/6	LS507206
XXXL/7	LS507207

ALL-IN-ONE LADY - 7mm

SIZE	CODE
XS/1	LS507301
S/2	LS507302
M/3	LS507303
L/4	LS507304
XL/5	LS507305
XXL/6	LS507306

COMFORT WETSUIT

5mm

- BACK ZIP
- 100% ELASTIC SPAN
- ELASTIC PLUSH INSIDE



ELASTIC-SPAN
ELASTIC PLUSH INSIDE

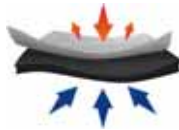

HOOD HOLDER



ALL-IN-ONE MAN - 5mm

SIZE	CODE
S/2	LS507002
M/3	LS507003
L/4	LS507004
XL/5	LS507005
XXL/6	LS507006
XXXL/7	LS507007

ALL-IN-ONE LADY - 5mm

SIZE	CODE
XS/1	LS507101
S/2	LS507102
M/3	LS507103
L/4	LS507104
XL/5	LS507105



PREMIUM
ULTRASTRETCH
NEOPRENE

16-24° C | CE Certification
61-75° F | EN 14225-1: C

One piece wet suit for temperate waters.
Made of 5mm-thick neoprene with Elastic-Span external lining and Elastic-Plush internal lining.
These materials enhance elasticity, heat level and wearability.
The zip is a YKK in order to guarantee maximum quality and is placed vertically on the rear-side of the suit.
The suit includes heavy duty kneepads for extra protection.



ICE SEMI DRY WETSUIT

7mm

- DRY BACK ZIP
- 100% HIGH STRETCH CONCEPT
- ELASTIC SPAN/ELASTIC PLUSH



PREMIUM ULTRASTRETCH NEOPRENE

10-18° C CE Certification
50-64° F EN 14225-1: B

One-piece 7 mm semi-dry suit for cold water. Very easy to wear thanks to special outer ELASTIC SPAN cover and internal ELASTIC PLUSH lining.
To facilitate the diver who carries important accessories, the suit is equipped with a convenient double compartment side pocket. One of them has a zipper closure while the other, intended for objects needing faster retrieval, has a Velcro closing. Two D-RINGS allow you to secure objects.
It has a HOOD HOLDER for attaching the hood and special SMALL DYMOND anti-abrasion reinforcements on the shoulders, knees and on the back side.
Double cuffs on wrists and ankles.
Comfortable waterproof MASTER SEAL rear zip.



HORIZONTAL DRY BACK TIZIP® MASTERSEAL



ELASTIC PLUSH INSIDE

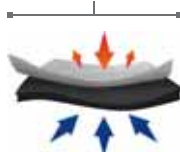

HIGH VOLUME POCKET D-RING AND HOOD HOLDER



ANKLES AND WRISTS WITH DOUBLE CUFFS



HIGH VOLUME POCKET D-RING AND HOOD HOLDER



HORIZONTAL DRY BACK TIZIP® MASTERSEAL



REINFORCED NEOPRENE



ALL-IN-ONE MAN - 7mm

SIZE	CODE
S/2	LQ403002
M/3	LQ403003
L/4	LQ403004
XL/5	LQ403005
XXL/6	LQ403006
XXXL/7	LQ403007

ALL-IN-ONE LADY - 7mm

SIZE	CODE
XS/1	LQ403101
S/2	LQ403102
M/3	LQ403103
L/4	LQ403104
XL/5	LQ403105

PLUS HOOD INCLUDED



FACILE WETSUIT

7mm

- FRONT ZIP
- 100% HIGH STRETCH CONCEPT
- ELASTIC SPAN/ELASTIC PLUSH



PREMIUM
ULTRASTRETCH
NEOPRENE

10-18° C | CE Certification
50-64° F | EN 14225-1: B

One-piece 7 mm wetsuit with attached hood for cold water. The suit is characterized by the WATER STOP SYSTEM whereby a particular bib inside creates a double barrier against water infiltration and improves thermal insulation. Transverse front zipper, along with the special ELASTIC SPAN cover and ELASTIC PLUSH lining, greatly facilitate the fit and donning. Special 5 mm inserts on the arms and legs improve the joint anatomy, enabling smoother motion. SMALL DYMOND anti abrasion reinforcements on the shoulder and back side. Hood with Airfree valve to remove the air. Wrists and ankles have double cuffs with a zip.



HOOD WITH
AIR FREE VALVE SYSTEM



ELASTIC-SPAN
ELASTIC PLUSH INSIDE

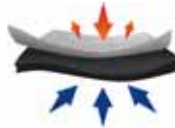

ANKLES AND WRISTS
WITH ZIPS
AND DOUBLE CUFFS

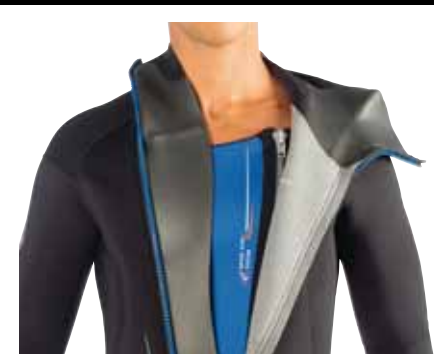

ALL-IN-ONE MAN - 7mm

SIZE	CODE
S/2	LT472802
M/3	LT472803
L/4	LT472804
XL/5	LT472805
XXL/6	LT472806

ALL-IN-ONE LADY - 7mm

SIZE	CODE
XS/1	LT472901
S/2	LT472902
M/3	LT472903
L/4	LT472904
XL/5	LT472905

FAST WETSUIT

7mm

BACK ZIP

NEW

10-18° C | CE Certification
50-64° F | EN 14225-1: B

Stylish, warm and versatile, the Fast can be used in the widest range of temperate and cold waters. Durable 7 mm, double-lined neoprene, stands up well to compression at depth for maximum heat retention. Pre-shaped legs improve flexibility for easier kicking.

TECHNICAL FEATURES

- One-piece 7 mm wetsuit in double lined neoprene
- Ultraspan neoprene on arms and calves
- Pre-shaped legs
- YKK back zip with under zip lining and water-stop system
- Anti-abrasion reinforcement on the knees
- Wrists and ankles with water-stop system / watertight seals



ULTRASOFT
NEOPRENE
ON ARMS

ANTI-ABRASION
REINFORCEMENT

ULTRASOFT
NEOPRENE
ON CALVES



UNDER ZIP LINING



WATERTIGHT SEALS



NEW DESIGN KNEEPAD



ALL-IN-ONE MAN - 7mm

SIZE	CODE
S/2	LR108702
M/3	LR108703
L/4	LR108704
XL/5	LR108705
XXL/6	LR108706
XXXL/7	LR108707

ALL-IN-ONE LADY - 7mm

SIZE	CODE
XS/1	LR109701
S/2	LR109702
M/3	LR109703
L/4	LR109704
XL/5	LR109705

FAST WETSUIT

5mm

BACK ZIP



NEW

16-24° C | CE Certification
61-75° F | EN 14225-1: C

Stylish, warm and versatile, the Fast can be used in the widest range of temperate waters. Durable 5 mm, double-lined neoprene, stands up well to compression at depth for maximum heat retention. Pre-shaped legs improve flexibility for easier kicking.

TECHNICAL FEATURES

- One-piece wetsuit in 5 mm double lined neoprene
- Pre-shaped legs
- YKK back zip with under zip lining and water-stop system
- Anti-abrasion reinforcement on the knees
- Wrists and ankles with water-stop system / watertight seals



UNDER ZIP LINING



WATERTIGHT SEALS



NEW DESIGN KNEEPAD



ALL-IN-ONE MAN - 5mm

SIZE	CODE
S/2	LR108502
M/3	LR108503
L/4	LR108504
XL/5	LR108505
XXL/6	LR108506
XXXL/7	LR108507

ALL-IN-ONE LADY - 5mm

SIZE	CODE
XS/1	LR109501
S/2	LR109502
M/3	LR109503
L/4	LR109504
XL/5	LR109505

FAST WETSUIT

3mm

BACK ZIP

CRESSI
Specialized
Retailer-Product

NEW

TECHNICAL FEATURES

- One-piece wetsuit in 3 mm double lined neoprene
- Pre-shaped legs
- YKK back zip with under zip lining
- Anti-abrasion reinforcement on the knees



ALL-IN-ONE MAN - 3mm

SIZE	CODE
S/2	LR108302
M/3	LR108303
L/4	LR108304
XL/5	LR108305
XXL/6	LR108306
XXXL/7	LR108307

ALL-IN-ONE LADY - 3mm

SIZE	CODE
XS/1	LR109301
S/2	LR109302
M/3	LR109303
L/4	LR109304
XL/5	LR109305

FISTERRA ULTRA DURABLE NEOPRENE



5-8mm

- └ DURABLE NEOPRENE
- └ PLUSH INSIDE



TWO PIECES wetsuit man - 5mm

SIZE	CODE
S/2	LK489002
M/3	LK489003
L/4	LK489004
XL/5	LK489005
XXL/6	LK489006

TWO PIECES wetsuit man - 8mm

SIZE	CODE
S/2	LK489502
M/3	LK489503
L/4	LK489504
XL/5	LK489505
XXL/6	LK489506

Double-lined, with nylon outside and Plush High Stretch inside.

Made with double-thick neoprene to protect against the cold while simultaneously allowing for good freedom of movement.

Watertight edges and Powertex reinforcement on the knees. Farmer John trousers

PLUSH INSIDE

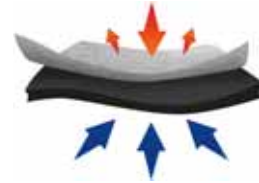

MEDAS WETSUIT

5mm

FRONT ZIP



16-24° C | CE Certification
61-75° F | EN 14225-1: C

TECHNICAL FEATURES

- Two-piece 5 mm wetsuit
- Double-lined with nylon outside and plush inside, thus providing a warm and comfortable feel
- YKK front zip with under zip lining
- Powertex anti-abrasion reinforcement on the knees
- Smooth skin with watertight seals around wrists and ankles



RESTYLING



TWO PIECES WETSUIT MAN - 5mm

SIZE	CODE
S/2	LK486502
M/3	LK486503
L/4	LK486504
XL/5	LK486505
XXL/6	LK486506

TWO PIECES WETSUIT LADY - 5mm

SIZE	CODE
XS/1	LK486401
S/2	LK486402
M/3	LK486403
L/4	LK486404
XL/5	LK486405



FREE FREEDIVING WETSUIT

3.5mm

- └ SECOND SKIN SMOOTH NEOPRENE
- └ X-THERMIC MATERIAL LINING



TWO PIECES WETSUIT MAN - 3,5mm

SIZE	CODE
XS/1	LF451001
S/2	LF451002
M/3	LF451003
L/4	LF451004
XL/5	LF451005

TWO PIECES WETSUIT LADY - 3,5mm

SIZE	CODE
XS/1	LF451101
S/2	LF451102
M/3	LF451103
L/4	LF451104

Cullmanery
-126m

PREMIUM
ULTRASTRETCH
NEOPRENE

This two-piece wetsuit has been specially conceived for free diving. Designed to facilitate penetration into the water, it features a very smooth outer surface made of neoprene that has undergone the "Second Skin" treatment, for greatly reduced friction in the water. The low-waist pants without shoulder straps do not apply pressure to the chest and promote effective ventilation.



SINGLE-PIECE UNDERARM SECTION
To improve arm extension



DOUBLE VELCRO SYSTEM



COMPLETE FREEDIVING RANGE



Cullmanery
-126m

MOREA WETSUIT

3mm
 BACK ZIP

TECHNICAL FEATURES

- 3-mm neoprene with Ultraspun ends on the arms and legs.
- Rubberized neoprene on the chest and protection on the knees.

NEW

MIXED ULTRASPAN MATERIAL

MAN ALL-IN-ONE MAN - 3mm

SIZE	CODE
S/2	LU476002
M/3	LU476003
L/4	LU476004
XL/5	LU476005
XXL/6	LU476006

KID ALL-IN-ONE JUNIOR - 3mm

AGE	SIZE	CODE
3-4	XXXS	LU476611
5-6	XXS	LU476612
6-7	XS	LU476601
8-9	S	LU476602
10-11	M	LU476603
12-13	L	LU476604
13-14	XL	LU476605

LADY ALL-IN-ONE LADY - 3mm

SIZE	CODE
XS/1	LU476501
S/2	LU476502
M/3	LU476503
L/4	LU476504
XL/5	LU476505

LUI - LEI WETSUIT

2.5mm

FRONT ZIP

TECHNICAL FEATURES

- Separate anatomical cuts for both men and women
- Front zip entry for easier donning
- YKK zipper and Aquastop under zip lining
- Aquastop wrist and ankle seals limit water exchange
- Pre-shaped legs improve flexibility for easy kicking



ALL-IN-ONE MAN - 2.5mm

SIZE	CODE
S/2	LU479002
M/3	LU479003
L/4	LU479004
XL/5	LU479005
XXL/6	LU479006

ALL-IN-ONE LADY - 2.5mm

SIZE	CODE
XS/1	LU478001
S/2	LU478002
M/3	LU478003
L/4	LU478004
XL/5	LU478005



MED X SHORTY WETSUIT

2,5mm

BACK ZIP



KID SHORTY JUNIOR - 2,5mm

AGE	SIZE	CODE
3-4	XXXS	LV438011
5-6	XXS	LV438012
6-7	XS	LV438001
8-9	S	LV438002
10-11	M	LV438003
12-13	L	LV438004
13-14	XL	LV438005



MAN SHORTY MAN - 2,5mm

SIZE	CODE
XS/1	LV437001
S/2	LV437002
M/3	LV437003
L/4	LV437004
XL/5	LV437005
XXL/6	LV437006



LADY SHORTY LADY - 2,5mm

SIZE	CODE
XS/1	LV437501
S/2	LV437502
M/3	LV437503
L/4	LV437504

Lightweight and easy to put on, it offers excellent freedom of movement.

TECHNICAL FEATURES

- Rear zip.
- Adjustable collar with Velcro closure.
- Children's sizes available.



LIDO SHORTY WETSUIT

2mm

FRONT ZIP



SHORTY JUNIOR - 2mm

AGE	SIZE	CODE
6-7	XS	LV458001
8-9	S	LV458002
10-11	M	LV458003
12-13	L	LV458004



SHORTY MAN - 2mm

SIZE	CODE
XS/1	LV455001
S/2	LV455002
M/3	LV455003
L/4	LV455004
XL/5	LV455005
XXL/6	LV455006
XXXL/7	LV455007



SHORTY LADY - 2mm

SIZE	CODE
XS/1	LV457001
S/2	LV457002
M/3	LV457003
L/4	LV457004
XL/5	LV457005

Highly flexible 2 mm neoprene and a flattering cut conform easily to most body shapes for a great fit.

TECHNICAL FEATURES

- Separate anatomical cuts for both men and women
- Double-lined neoprene
- Front zip entry for easier donning

PLAYA SHORTY WETSUIT

2.5mm

FRONT ZIP



SHORTY MAN - 2.5 mm

SIZE	CODE
XS/1	LV445001
S/2	LV445002
M/3	LV445003
L/4	LV445004
XL/5	LV445005
XXL/6	LV445006



SHORTY LADY - 2.5 mm

SIZE	CODE
XS/1	LV446001
S/2	LV446002
M/3	LV446003
L/4	LV446004

TECHNICAL FEATURES

- Separate anatomical cuts for both men and women
- Single neoprene cuff seals
- Front zip entry for easier donning

DIVER WETSUIT

7mm

5mm

FRONT ZIP



7mm

10-18° C | CE Certification
50-64° F | EN 14225-1: B

5mm

16-24° C | CE Certification
61-75° F | EN 14225-1: C

All-in-one suit available in 5 and 7 mm double lined neoprene, with incorporated hood and front zip fastening which has recently been up dated, both technically and aesthetically. Traditional all-in-one suit for dives in warm waters, very easy to put on and take off, designed to offer great freedom of movement. The legs are pre-shaped to allow the natural, typical bending of the limbs when swimming. The front zip stretches from the waist to the right cheek. A smooth neoprene seal runs along the edge of the facial profile of the hood thus limiting water infiltration and increasing comfort. There are reinforced anti-wear pads on the knees. At the wrists the seal is guaranteed by double lined cuffs, the same solution is also used at the ankles, in this case, however, they have handy zips to help the user put on and take off the suit. Available in men's, women's and children's versions.

WHO IT IS FOR

Diver is a wetsuit that has been designed for scuba diving in warm waters, like those of the Mediterranean during the summer months, or those of the tropics during the winter seasons.

Quick and easy to put on and take off, it offers great freedom of movement and is much appreciated by diving guides and by those who have to perform several dives on the same day.

KID ALL-IN-ONE JUNIOR - 5mm

AGE	SIZE	CODE
8	XXXS	LU489001
10	XXS	LU489002
12	XS	LU489003

MAN ALL-IN-ONE MAN - 5mm

SIZE	CODE
S/2	LU489502
M/3	LU489503
L/4	LU489504
XL/5	LU489505
XXL/6	LU489506
XXXL/7	LU489507

ALL-IN-ONE MAN - 7mm

SIZE	CODE
S/2	LU489602
M/3	LU489603
L/4	LU489604
XL/5	LU489605
XXL/6	LU489606

LADY ALL-IN-ONE LADY - 5mm

SIZE	CODE
XS/1	LU488001
S/2	LU488002
M/3	LU488003
L/4	LU488004
XL/5	LU488005

ALL-IN-ONE LADY - 7mm

SIZE	CODE
XS/1	LU489701
S/2	LU489702
M/3	LU489703
L/4	LU489704
XL/5	LU489705

REINFORCED NEOPRENE



ANKLE ZIPPER

ENDURANCE WETSUIT

5mm

- FRONT ZIP
- JUNIOR & LADY SIZES AVAILABLE



5 mm one piece double lined neoprene diving suit. Conceived for intensive use in tepid waters. Easy to put on thanks to its YKK zippers: a heavy duty one on the front and two on the ankles. In the areas most exposed to wear on the part of the jacket, such as the belly and the shoulders, "Xdiamond", a special neoprene ensuring superior resistance to abrasion, is used. Special neoprene also covers the back and the knees, which are subjected to high stresses.

REINFORCED PADS X DIAMOND ULTRARESISTANT MATERIAL

SHOULDERS



WAIST



BACK

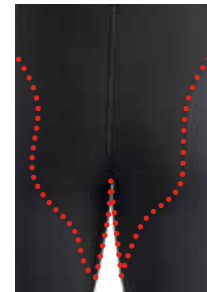

KNEES



ANKLE ZIPPER



3 MM HOOD OPTIONAL: PAGE 85



3 mm double lined neoprene hood.

KID

ALL-IN-ONE JUNIOR - 5mm

AGE	SIZE	CODE
8	XS	JLV498001
10	S	JLV498002
12	M	JLV498003
14	L	JLV498004

MAN

ALL-IN-ONE MAN - 5mm

SIZE	CODE
S/2	JLV495002
M/3	JLV495003
L/4	JLV495004
XL/5	JLV495005
XXL/6	JLV495006

LADY

ALL-IN-ONE LADY - 5mm

SIZE	CODE
XS/1	JLV497001
S/2	JLV497002
M/3	JLV497003
L/4	JLV497004

ENDURANCE SHORTY

SHORTY WETSUIT

3mm

- FRONT ZIP
- JUNIOR & LADY SIZES AVAILABLE



CRESSI
dive center

REINFORCED PADS
X DIAMOND ULTRARESISTANT MATERIAL

SHOULDERS



WAIST



BACK

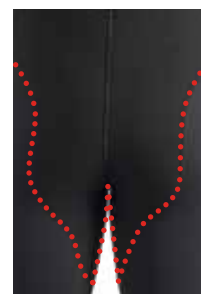

KID SHORTY JUNIOR - 3mm

AGE	SIZE	CODE
8	XS	JLV478001
10	S	JLV478002
12	M	JLV478003
14	L	JLV478004

MAN SHORTY MAN - 3mm

SIZE	CODE
S/2	JLV475002
M/3	JLV475003
L/4	JLV475004
XL/5	JLV475005
XXL/6	JLV475006

LADY SHORTY LADY - 3mm

SIZE	CODE
XS/1	JLV477001
S/2	JLV477002
M/3	JLV477003
L/4	JLV477004

RASH GUARD

LONG SLEEVE



NEW



MAN

SIZE	CODE
S/2	JLW478502
M/3	JLW478503
L/4	JLW478504
XL/5	JLW478505
XXL/6	JLW478506
XXXL/7	JLW478507

LADY

SIZE	CODE
XS/1	JLW478601
S/2	JLW478602
M/3	JLW478603
L/4	JLW478604
XL/5	JLW478605



WHITE PAD
TO WRITE
NAME
OR NUMBER

RASH GUARD

SHORT SLEEVE



NEW



MAN

SIZE	CODE
S/2	JLW478302
M/3	JLW478303
L/4	JLW478304
XL/5	JLW478305
XXL/6	JLW478306
XXXL/7	JLW478307

LADY

SIZE	CODE
XS/1	JLW478401
S/2	JLW478402
M/3	JLW478403
L/4	JLW478404
XL/5	JLW478405



WHITE PAD
TO WRITE
NAME
OR NUMBER

SHELL JACKET

MULTI THICKNESS

5mm - 3.5mm



JACKET MAN

SIZE	CODE
S/2	LS560002
M/3	LS560003
L/4	LS560004
XL/5	LS560005
XXL/6	LS560006
XXXL/7	LS560007

JACKET LADY

SIZE	CODE
XS/1	LS561001
S/2	LS561002
M/3	LS561003
L/4	LS561004
XL/5	LS561005

CORE VEST

3mm

REVERSE FRONT ZIP



SIZE	CODE
XS/1	LW476301
S/2	LW476302
M/3	LW476303
L/4	LW476304
XL/5	LW476305
XXL/6	LW476306

ZIP VEST

3mm

FRONT ZIP



SIZE	CODE
XS/1	LW476401
S/2	LW476402
M/3	LW476403
L/4	LW476404
XL/5	LW476405
XXL/6	LW476406

BALA HOOD

5mm

- └ INTEGRATED AIR / WATER RELEASE SYSTEM
- └ 100% HIGH-STRETCH MATERIAL



MAN - 5mm

SIZE	CODE
S/2	LS600001
M/3-4	LS600002
L/5-6-7	LS600003

LADY - 5mm

SIZE	CODE
XS/1	LS600100
S/2-3	LS600101
M/4-5	LS600102

NEW

Hood with an oversized crew neck that allows a better water tightness for those who want to use it by inserting it under the neck of the wetsuit. It is particularly suitable for one-piece wetsuits with a front zip. Anatomical cut. 100% high-stretch material. 3 mm smooth skin with watertight seals around the face and the neck. Integrated air / water release system on the upper part of the hood. Hidden hood holder on the back.



PLUS HOOD

5mm



MAN - 5mm

SIZE	CODE
S/2	LS550601
M/3-4	LS550602
L/5-6-7	LS550603

LADY - 5mm

SIZE	CODE
XS/1	LS551200
S/2-3	LS551201
M/4-5	LS551202

STANDARD HOOD

5mm

3mm



UNISEX - 3mm

SIZE	CODE
XS/1	LR108001
S/2	LR108002
M/3-4	LR108003
L/5-6-7	LR108004

MAN - 5mm

SIZE	CODE
S/2	LR107401
M/3-4	LR107402
L/5-6-7	LR107403

LADY - 5mm

SIZE	CODE
XS/1	LR107500
S/2-3	LR107501
M/4-5	LR107502

TRACTION BOOTS

CRESSI
Atelier
offline product

5mm



NEW

HARD SOLE



HARD
SOLE

SIZE	EU	MM	CODE
XS	36-37	5	LX432900
S	38-39	5	LX432901
M	40-41	5	LX432902
L	42-43	5	LX432903
XL	44-45	5	LX432904
XXL	46-47	5	LX432905



GRIPPER GLOVES

CRESSI
Atelier
offline product

5mm



NEW

EMBOSSED GRIP



SIZE	MM	CODE
S	5	LX476401
M	5	LX476402
L	5	LX476403



LUX DRY DRYSUIT BOOTS

5mm

SIZE	EU	MM	CODE
S	38-39	5	LX432801
M	40-41	5	LX432802
L	42-43	5	LX432803
XL	44-45	5	LX432804
XXL	46-47	5	LX432805



ISLA BOOTS

3mm 5mm 7mm

These boots are designed to be used with open heel fins. They are made from soft, double-lined neoprene and have a practical zip from the sole to the ankle, making them easy to slip on and off. Water seepage is reduced to the minimum thanks to a thin flap seal under the zip, which acts as an effective barrier against any water that may seep through the zip. Strong non-slip moulding covers the entire sole. Reinforcements on the back of the foot and the heel provide protection against wear and tear.



SIZE	EU	MM	CODE
XS	36-37	3	LX432000
S	38-39	3	LX432001
M	40-41	3	LX432002
L	42-43	3	LX432003
XL	44-45	3	LX432004

SIZE	EU	MM	CODE
XS	36-37	5	LX432500
S	38-39	5	LX432501
M	40-41	5	LX432502
L	42-43	5	LX432503
XL	44-45	5	LX432504
XXL	46-47	5	LX432505

SIZE	EU	MM	CODE
XS	36-37	7	LX432600
S	38-39	7	LX432601
M	40-41	7	LX432602
L	42-43	7	LX432603
XL	44-45	7	LX432604
XXL	46-47	7	LX432605

ULTRASPAN BOOTS

5mm

Boots with non-slip soles are ideal for use with open heel fins. Reinforcements on the back of the foot and the heel provide protection against wear and tear.

SIZE	EU	MM	CODE
XS	36-37	5	LX432700
S	38-39	5	LX432701
M	40-41	5	LX432702
L	42-43	5	LX432703
XL	44-45	5	LX432704
XXL	46-47	5	LX432705



LOW BOOTS

SHORT BOOTS

3mm

3 mm neoprene boots, with non-slip soles, highly elastic and comfortable.

SIZE	EU	MM	CODE
XS	36-37	3	XLX430900
S	38-39	3	XLX430901
M	40-41	3	XLX430902
L	42-43	3	XLX430903
XL	44-45	3	XLX430904
XXL	46-47	3	XLX430905



METALLITE

NEOPRENE SOCKS - NON SLIP SOLE

2.5mm

These are single-lined, thin, high stretch neoprene boots. The inner is lined in Metallite so they are easy to put on. The sole has an effective non-slip lining. They can be used with both closed foot fins to protect the skin from scratches and chafing, as well as with firm-soled boots, using open-heel fins.

SIZE	EU	MM	CODE
S	36-38	2.5	LX433001
M	39-40	2.5	LX433002
L	41-43	2.5	LX433003
XL	44-46	2.5	LX433004



ULTRA STRETCH

NEOPRENE SOCKS - NON SLIP SOLE

1.5mm

Created in extremely supple, 1.5 mm thick, double-lined Ultraspan neoprene, these boots have non-slip and anti-wear soles and an Aquastop sealin single-lined neoprene at the top.

SIZE	EU	MM	CODE
S	36-39	1.5	DF200030
M	40-42	1.5	DF200031
L	43-45	1.5	DF200032



FINS SOCKS

ULTRA STRECH TEXTILE MATERIAL

These fin-socks are designed for people who live in their fins and need that perfect snug fit of a full foot fin. But also for people who seldom use fins or have sensitive feet. These socks are the solution that will allow you wearing your fins for hours an more without chafing your feet.

SIZE	EU	CODE
S/M	36-41	USW030000K
L/XL	42-46	USW031000K



SVALBARD GLOVES

6mm

Five fingered gloves in 6 mm thick neoprene, created for use in cold and freezing waters. Entirely made from very supple Ultraspán material, they allow an excellent grip despite their considerable thickness. The back is black while the palm is grey and they are sewn and glued with non-pass-through stitching.

SIZE	MM	CODE
S	6	LX476201
M	6	LX476202
L	6	LX476203



ULTRASPAN GLOVES

3.5mm

5 finger neoprene gloves Ultraspán in addition to the already 'full range of gloves Cressi want to combine the flexibility of these new materials come onto the market over the past years with the wear resistance of previous models.

TECHNICAL FEATURES For this particular model have been studied as important as the depth of the fingers, perfect closing of the wrist, not through seams.

SIZE	MM	CODE
XS	3.5	LX476310
S	3.5	LX476311
M	3.5	LX476312
L	3.5	LX476313
XL	3.5	LX476314



HIGH STRETCH GLOVES

2.5mm **3.5mm** **5mm**

5-finger gloves made from single-lined soft, high-stretch neoprene. The inside is covered in Metallite to make them easy to put on. The preformed shape favours the natural position of the hand, with semi-bent fingers. The entire surface is covered with a non-slip finish for a sure grip in all situations.

SIZE	MM	CODE
S	2.5	LX475701
M	2.5	LX475702
L	2.5	LX475703
XL	2.5	LX475704

SIZE	MM	CODE
S	3.5	LX475801
M	3.5	LX475802
L	3.5	LX475803
XL	3.5	LX475804



SIZE	MM	CODE
S	5	LX475901
M	5	LX475902
L	5	LX475903
XL	5	LX475904

TROPICAL GLOVES

2mm

Five fingered gloves 2 mm thick neoprene, made from two different soft and light materials. The palm and finger area uses a light grey napa that becomes extraordinarily soft upon contact with the water. However, the upper part of the glove and the wrist area are made from very thin, supple neoprene. A large area that corresponds to the upper side of the wrist allows for instant adjustment, both before and during the dive. These are particularly suitable gloves when you need the very best touch sensitivity in the fingers. The palm also offers good resistance to abrasions.

SIZE	MM	CODE
S	2	LX475301
M	2	LX475302
L	2	LX475303
XL	2	LX475304



SIZE CHART

DRY SUITS SIZE CHART MEN'S

SIZE	WEIGHT		HEIGHT		CHEST		WAIST		HIP		FOOT		
	kg	lbs	cm	inch	cm	inch	cm	inch	cm	inch	EU	UK	US
S/II/48	60/68	132/150	164/170	65/67	78/83	31/33	65/71	25/28	78/83	31/33	40/42	7/8	7,5/8,5
M/III/50	70/78	154/172	169/175	67/69	86/91	34/36	71/77	28/30	84/89	33/35	41/43	7,5/8,5	8/9
L/IV/52	80/88	176/194	174/180	69/71	94/99	37/39	77/83	30/33	90/95	35/37	42/44	8/10	8,5/10,5
XLV/54	90/98	198/216	179/185	71/73	102/107	40/42	83/89	33/35	96/101	38/40	43/45	8,5/11	9/11,5
XXLVI/56	100/108	220/238	184/190	73/75	110/115	43/45	89/95	35/37	102/107	40/42	44/46	10/11,5	10,5/12

DRY SUITS SIZE CHART WOMEN'S

SIZE	WEIGHT		HEIGHT		CHEST		WAIST		HIP		FOOT		
	kg	lbs	cm	inch	cm	inch	cm	inch	cm	inch	EU	UK	US
XS/I/42	47/52	104/115	157/162	62/64	77/82	30/32	56/61	22/24	83/87	32/34	37/39	4,5/6,5	5/7
S/II/44	53/58	117/128	162/167	64/66	82/87	32/34	60/65	24/26	87/91	34/36	38/40	5,5/7	6/7,5
M/III/46	59/64	130/141	167/172	66/68	87/92	34/36	64/69	25/27	91/95	36/37	39/41	6,5/7,5	7/8
L/IV/48	64/70	141/154	172/177	68/70	92/97	36/38	68/73	27/29	95/99	37/39	40/42	7/8	7,5/8,5
XLV/50	70/80	154/176	177/182	70/72	97/102	38/40	72/77	28/30	99/103	39/41	41/43	7,5/8,5	8/9

DIVE SUITS SIZE CHART MEN'S (semi-dry all-in-one two-pieces jacket/pants)

SIZE	WEIGHT		HEIGHT		CHEST		WAIST		HIP	
	kg	lbs	cm	inch	cm	inch	cm	inch	cm	inch
S/II/48	60/68	132/150	164/173	65/68	78/83	31/33	65/71	25/28	78/83	31/33
M/III/50	70/78	154/172	169/178	67/70	86/91	34/36	71/77	28/30	84/89	33/35
L/IV/52	80/88	176/194	174/183	69/72	94/99	37/39	77/83	30/33	90/95	35/37
XLV/54	90/98	198/216	179/188	71/74	102/107	40/42	83/89	33/35	96/101	38/40
XXLVI/56	100/108	220/238	184/193	72/76	110/115	43/45	89/95	35/37	102/107	40/42
XXXLVII/58	105/115	231/254	191/198	75/78	118/123	46/48	95/101	37/40	108/113	43/45

DIVE SUITS SIZE CHART WOMEN'S (semi-dry all-in-one two-pieces jacket/pants)

SIZE	WEIGHT		HEIGHT		CHEST		WAIST		HIP	
	kg	lbs	cm	inch	cm	inch	cm	inch	cm	inch
XS/I/40	47/52	104/115	160/165	63/65	77/82	30/32	56/61	22/24	83/87	32/34
S/II/42	53/58	117/128	165/170	65/67	82/87	32/34	60/65	24/26	87/91	34/36
M/III/44	59/64	130/141	170/175	67/69	87/92	34/36	64/69	25/27	91/95	36/37
L/IV/46	64/70	141/154	175/180	69/71	92/97	36/38	68/73	27/29	95/99	37/39
XLV/48	70/80	154/176	180/185	71/73	97/102	38/40	72/77	28/30	99/103	39/41

SHORTY WETSUITS SIZE CHART MEN'S

SIZE	WEIGHT		HEIGHT		CHEST		WAIST		HIP	
	kg	lbs	cm	inch	cm	inch	cm	inch	cm	inch
XS/I/46	50/58	110/128	156/165	61/65	70/75	28/30	59/65	23/26	72/77	28/30
S/II/48	60/68	132/150	164/173	65/68	78/83	31/33	65/71	26/28	78/83	31/33
M/III/50	70/78	154/172	169/178	67/70	86/91	34/36	71/77	28/30	84/89	33/35
L/IV/52	80/88	176/194	174/183	69/72	94/99	37/39	77/83	30/33	90/95	35/37
XLV/54	90/98	198/216	179/188	71/74	102/107	40/42	83/89	33/35	96/101	38/40
XXLVI/56	100/108	220/238	184/193	72/76	110/115	43/45	89/95	35/37	102/107	40/42

SHORTY WETSUITS SIZE CHART WOMEN'S

SIZE	WEIGHT		HEIGHT		CHEST		WAIST		HIP	
	kg	lbs	cm	inch	cm	inch	cm	inch	cm	inch
XS/I/40	47/52	104/115	160/165	63/65	77/82	30/32	56/61	22/24	83/87	32/34
S/II/42	53/58	117/128	165/170	65/67	82/87	32/34	60/65	24/26	87/91	34/36
M/III/44-46	59/64	130/141	170/175	67/69	87/92	34/36	64/69	25/27	91/95	36/37
L/IV/48-50	64/70	141/154	175/180	69/71	92/97	36/38	68/73	27/29	95/99	37/39

TRITON SWIMMING WETSUIT

1.5mm

- BACK ZIP
- OPEN WATER
- UV PROTECTION
- QUICK DRYING
- SUPER STRETCH



ALL-IN-ONE MAN - 1,5mm

SIZE	CODE
XS/1	DG002201
S/2	DG002202
M/3	DG002203
L/4	DG002204
XL/5	DG002205
XXL/6	DG002206

ALL-IN-ONE LADY - 1,5mm

SIZE	CODE
XS/1	DG002301
S/2	DG002302
M/3	DG002303
L/4	DG002304

18-26° C
70-80° F

Wetsuit made of 1.5 mm neoprene ULTRASKIN for swimming in open water. For safety, it has a special insert in the forearms, fluorescent green for men or fluorescent orange for women, that allows immediate sighting during the activity. It also features a key pocket and a label for a name.

HIGH VISIBILITY PADS
FOR IMPROVED SECURITY

ANTI-SEEPAGE COLLAR

YKK REAR ZIP

DEA

SWIMMING NEOPRENE WETSUIT

Cressi
swim

1mm

- ZIPLESS
- 100% HIGH STRETCH CONCEPT
- OPEN WATER
- AQUA GYM
- SWIMMING POOL



BLACK

SIZE	CODE
XS/1	DG005401
S/2	DG005402
M/3	DG005403
L/4	DG005404
XL/5	DG005405



BLACK/WHITE/ORANGE

SIZE	CODE
XS/1	DG005601
S/2	DG005602
M/3	DG005603
L/4	DG005604
XL/5	DG005605



BLACK/WHITE

SIZE	CODE
XS/1	DG005501
S/2	DG005502
M/3	DG005503
L/4	DG005504
XL/5	DG005505

NEW

18-26° C
70-80° F

Designed specifically for swimming, snorkeling and water sports in general, it is a valid alternative to traditional lycra bathing suits, particularly when better thermal comfort is required.

This model offers a great freedom of movement, thanks to the special cut and elasticity of the materials, that allow you to easily wear the costume without the use of zips. Upper part in single lined neoprene with smooth skin inside, which acts as aqua stop, and double lined in the lower part.

TECHNICAL FEATURES

- Anatomically designed to give women maximum comfort and wearability
- Stylish, without zip
- 100% ultra stretch concept
- Upper part with smooth skin inside
- Suitable for open waters, swimming pool and aquagym

TERMICO LADY

SWIMMING WETSUIT

Cressi
swim

2mm

18-26° C
70-80° F

- FRONT ZIP
- 100% HIGH STRETCH CONCEPT
- OPEN WATER
- AQUA GYM
- SWIMMING POOL



2mm
ULTRASPAN LINED
NEOPRENE

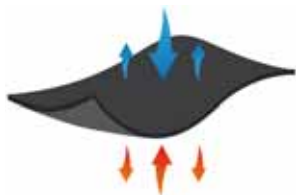

Women's all-in-one suit that is shaped like a one-piece swimsuit. The first suit that provides thermal comfort. In soft 2 mm neoprene. Designed specifically for swimming, snorkeling and water sports in general, it allows great freedom of movement thanks to the special style and elasticity of the material. It is made from double lined 2 mm neoprene and comes with a front zip that makes it easy to put on and take off.

ALL-IN-ONE LADY - 2mm

SIZE	CODE
XS/1	DG000501
S/2	DG000502
M/3	DG000503
L/4	DG000504
XL/5	DG000505

TERMICO MAN

SWIMMING SHORTY WETSUIT

Cressi
swim

2mm

18-26° C
70-80° F

- FRONT ZIP
- 100% HIGH STRETCH CONCEPT
- OPEN WATER
- AQUA GYM
- SWIMMING POOL



ANTI-FRICTION GLIDE-SKIN

2mm
ULTRASPAN LINED
NEOPRENE



Thermal comfort shorty for swimming, in highly elastic 2-mm Ultraspan lined neoprene. Glide-skin anti-friction treatment in the underarm area. Glide-skin anti-seepage seals at the neck and legs.

SHORTY MAN - 2mm

SIZE	CODE
S/2	DG000902
M/3	DG000903
L/4	DG000904
XL/5	DG000905
XXL/6	DG000906

DIVA

SWIMMING WETSUIT

Cressi
swim

2mm

- FRONT ZIP
- 100% HIGH STRETCH CONCEPT
- OPEN WATER
- AQUA GYM
- SWIMMING POOL

18-26° C
70-80° F



ALL-IN-ONE LADY - 2mm

SIZE	CODE
XS/1	DG001301
S/2	DG001302
M/3	DG001303
L/4	DG001304
XL/5	DG001305



CRESSI

F I N S

BUYER'S GUIDE 2019

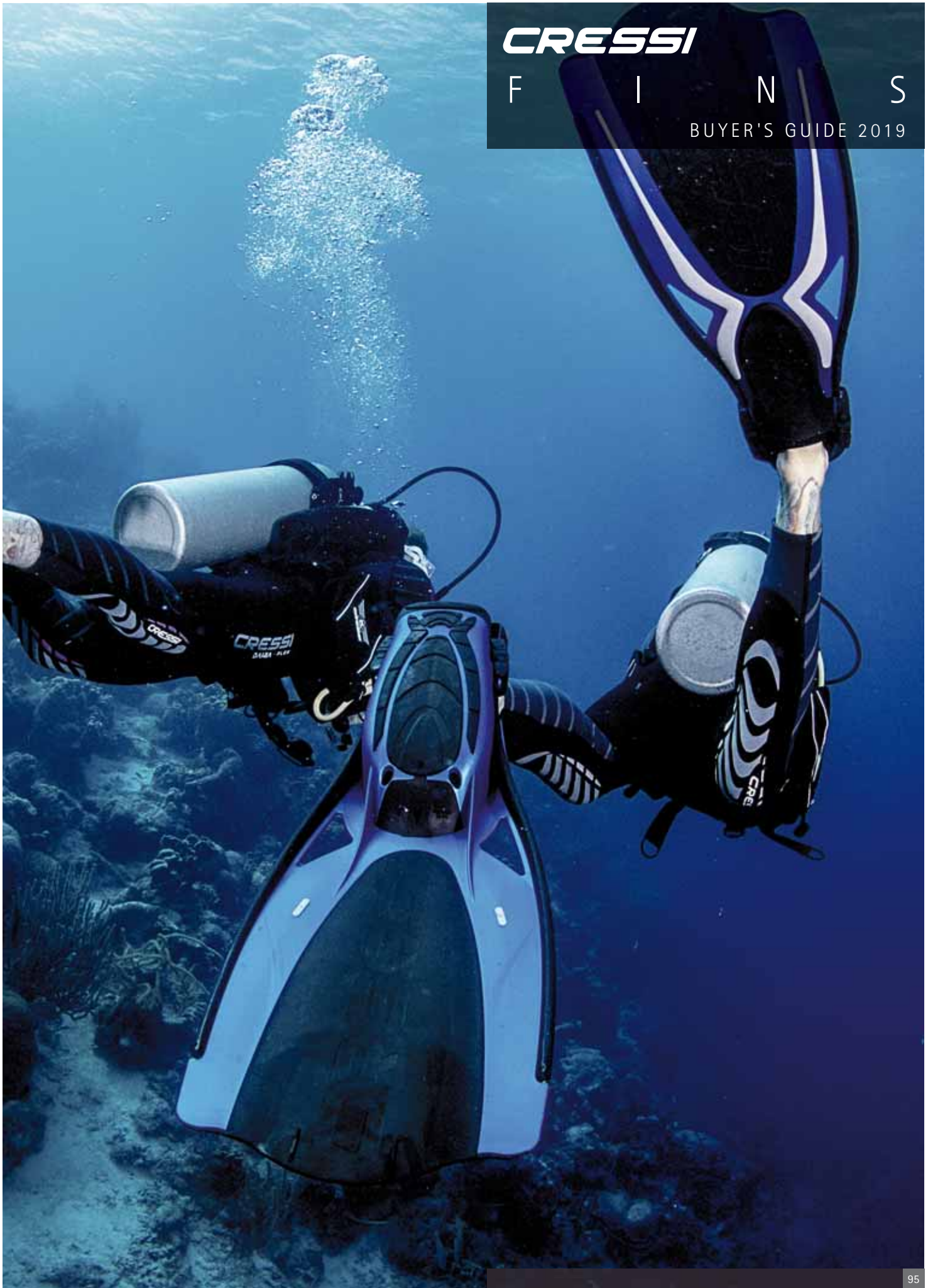

THOR EBS

EBS ELASTIC BUNGEE SYSTEM



FLOW CONVECTION EFFECT

SPECIAL ARCHED PROFILE

Brand new design for this extremely effective and yet very easy to use fin. The special arched profile of the fins combined with the two central ribs promote a significant flow convection effect, known as "spoon effect", which stabilises and boosts propulsion. Two lateral holes discharge the negative forces typically associated with this area and at the same time make for enhanced stability. The blades are moulded from two different materials for improved reactivity. These fins are perfect for scuba diving, whether you are an experienced diver or a novice.



Cressi has developed this special strap to meet the needs of the most demanding divers, who need a comfortable fastening for their foot but one that is still practical and manageable. Its special amply sized slot makes it very easy to put on, even when wearing thick gloves or three-fingered gloves for winter water.

The wrapping section is highly flexible, making adjustments unnecessary, and as a result it's much easier to get all your equipment right in the first few meters of your descent and the fin stays in place against your foot despite the increase in hydrostatic pressure.

THOR EBS

EBS ELASTIC BUNGEE SYSTEM

NEW



NEW



NEW



	COLOURS	SIZE	SIZE EU	PACK	CODE
	THOR EBS BLACK/SILVER	XS/S	36/38	3	BE155036
	THOR EBS BLACK/SILVER	S/M	39/41	3	BE155039
	THOR EBS BLACK/SILVER	L	42/44	3	BE155042
	THOR EBS BLACK/SILVER	XL	45/49	3	BE155045
N!	THOR EBS BLACK/YELLOW	XS/S	36/38	3	BE151036
N!	THOR EBS BLACK/YELLOW	S/M	39/41	3	BE151039
N!	THOR EBS BLACK/YELLOW	L	42/44	3	BE151042
N!	THOR EBS BLACK/YELLOW	XL	45/49	3	BE151045
N!	THOR EBS BLUE	XS/S	36/38	3	BE152036
N!	THOR EBS BLUE	S/M	39/41	3	BE152039
N!	THOR EBS BLUE	L	42/44	3	BE152042
N!	THOR EBS BLUE	XL	45/49	3	BE152045
N!	THOR EBS PINK	XS/S	36/38	3	BE154036
N!	THOR EBS PINK	S/M	39/41	3	BE154039



ARA EBS

EBS ELASTIC BUNGEE SYSTEM



WIDER FOOTPOCKET
FOR INCREASED COMFORT



EBS STRAP

Cressi has developed this special strap to meet the needs of the most demanding divers, who need a comfortable fastening for their foot but one that is still practical and manageable. Its special amply sized slot makes it very easy to put on, even when wearing thick gloves or three-fingered gloves for winter water.

The wrapping section is highly flexible, making adjustments unnecessary, and as a result it's much easier to get all your equipment right in the first few meters of your descent and the fin stays in place against your foot despite the increase in hydrostatic pressure.

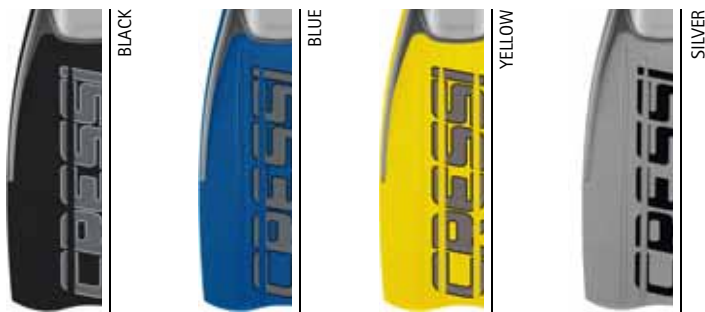

COLOURS	SIZE	SIZE EU	PACK	CODE
ARA BLACK	S/M	39/41	3	BE135540
ARA BLACK	M/L	41/43	3	BE135542
ARA BLACK	L/XL	44/47	3	BE135544
ARA BLUE	S/M	39/41	3	BE136240
ARA BLUE	M/L	41/43	3	BE136242
ARA BLUE	L/XL	44/47	3	BE136244
ARA YELLOW	S/M	39/41	3	BE131040
ARA YELLOW	M/L	41/43	3	BE131042
ARA YELLOW	L/XL	44/47	3	BE131044
ARA SILVER	S/M	39/41	3	BE135140
ARA SILVER	M/L	41/43	3	BE135142
ARA SILVER	L/XL	44/47	3	BE135144

REACTION EBS

EBS ELASTIC BUNGEE SYSTEM



Cressi's most technically advanced fin, the Reaction uses a completely new polypropylene blade material that is more reactive, flexible and trim than previous designs. It kicks easily yet powerfully and is suitable for divers of every experience level.

The new, longer blade efficiently transfers energy from the computer-designed foot pocket, and like other Cressi fins, the blade extends from the top of the foot pocket to maximize its effective surface area for more thrust. Other innovations include new locking strap buckles and no-slip material for better traction out of the water.



EBS STRAP

Cressi has developed this special strap to meet the needs of the most demanding divers, who need a comfortable fastening for their foot but one that is still practical and manageable. Its special amply sized slot makes it very easy to put on, even when wearing thick gloves or three-fingered gloves for winter water.

The wrapping section is highly flexible, making adjustments unnecessary, and as a result it's much easier to get all your equipment right in the first few meters of your descent and the fin stays in place against your foot despite the increase in hydrostatic pressure.



COLOURS	SIZE	SIZE EU	PACK	CODE
REACTION EBS BLUE/AZURE	XS/S	36/39	3	BE092038
REACTION EBS BLUE/AZURE	S/M	39/42	3	BE092040
REACTION EBS BLUE/AZURE	M/L	42/45	3	BE092042
REACTION EBS BLUE/AZURE	L/XL	45/47	3	BE092044
REACTION EBS FINS BLACK/SILVER	XS/S	36/39	3	BE095538
REACTION EBS FINS BLACK/SILVER	S/M	39/42	3	BE095540
REACTION EBS FINS BLACK/SILVER	M/L	42/45	3	BE095542
REACTION EBS FINS BLACK/SILVER	L/XL	45/47	3	BE095544
REACTION EBS WHITE/PINK	XS/S	36/39	3	BE096438
REACTION EBS WHITE/PINK	S/M	39/42	3	BE096440
REACTION EBS YELLOW/SILVER	XS/S	36/39	3	BE091038
REACTION EBS YELLOW/SILVER	S/M	39/42	3	BE091040
REACTION EBS YELLOW/SILVER	M/L	42/45	3	BE091042
REACTION EBS YELLOW/SILVER	L/XL	45/47	3	BE091044



FROG PLUS



- DOUBLE DENSITY TECHNOLOGY
- SUPERIOR PERFORMANCE



The Frog Plus utilizes Cressi's patented three material injection molding process.

The three materials consist of a nice comfortable rubber on the foot pocket that extends up the side rails of the blade.

The second material is the revolutionary new dual density techno polymer which forms the blade, and in conjunction with the third silicone based material creates a channeling effect.

Cressi's latest addition to its extensive line of world renowned fins is the Frog Plus open heel scuba diving fin.

The Frog Plus features many of the great characteristics of a traditional paddle fin along with introducing a revolutionary new blade material that is both extremely durable and nearly indestructible.

The Frog Plus utilizes Cressi's patented three material injection molding process.

The three materials consist of a nice comfortable rubber on the foot pocket that extends up the side rails of the blade.

The second material is the revolutionary new dual density techno polymer which forms the blade, and in conjunction with the third silicone based material creates a channeling effect.



BLACK/SILVER



BLACK/YELLOW



BLUE/SILVER



BLACK/PINK



BLACK/WHITE

COLOURS	SIZE	SIZE EU	PACK	CODE
FROG PLUS BLACK/SILVER	XS/S	36/39	3	BF205538
FROG PLUS BLACK/SILVER	S/M	39/42	3	BF205540
FROG PLUS BLACK/SILVER	M/L	42/45	3	BF205542
FROG PLUS BLACK/SILVER	L/XL	45/47	3	BF205544
FROG PLUS BLACK/YELLOW	XS/S	36/39	3	BF205138
FROG PLUS BLACK/YELLOW	S/M	39/42	3	BF205140
FROG PLUS BLACK/YELLOW	M/L	42/45	3	BF205142
FROG PLUS BLACK/YELLOW	L/XL	45/47	3	BF205144
FROG PLUS BLUE/SILVER	XS/S	36/39	3	BF202038
FROG PLUS BLUE/SILVER	S/M	39/42	3	BF202040
FROG PLUS BLUE/SILVER	M/L	42/45	3	BF202042
FROG PLUS BLUE/SILVER	L/XL	45/47	3	BF202044
FROG PLUS BLACK/PINK	XS/S	36/39	3	BF205438
FROG PLUS BLACK/PINK	S/M	39/42	3	BF205440
FROG PLUS BLACK/WHITE	XS/S	36/39	3	BF203038
FROG PLUS BLACK/WHITE	S/M	39/42	3	BF203040
FROG PLUS BLACK/WHITE	M/L	42/45	3	BF203042
FROG PLUS BLACK/WHITE	L/XL	45/47	3	BF203044

OPTIONAL EBS STRAP

EBS STRAP - PAIR	SIZE	CODE
REACTION - FROG PLUS	SHORT FIT (XS/S - S/M)	BZ150001
REACTION - FROG PLUS	REGULAR FIT (S/M - M/L)	BZ150002
REACTION - FROG PLUS	EXTENDED FIT (M/L - L/XL)	BZ150003



PRO LIGHT



A highly advanced design for this fin that is moulded from two materials with very different characteristics: a strong polypropylene for the blade and soft elastomers (thermo rubber) for the foot and protective inserts. The result is an extremely light and well-balanced fin, of average size, with surprising reaction time and a formidable thrust.

The side stringers that extend all along the blade and two flaps situated along the end of the blade itself make the fin very directional.

The blade originates from the upper part of the foot pocket, with a 20% increase in useful surface area compared to a traditional fin of the same length.

The foot pocket is computer designed and guarantees ideal transmission of the leg-fin thrust.

The lightness and perfect balance of the materials, together with the extremely modern design, make Rondine Pro Light a generous fin that provides exuberant performance without too much physical effort.

These fins are perfect both for beginners and for professionals and are very common amongst instructors and technical divers.



COLOURS	SIZE	SIZE EU	PACK	CODE
PRO LIGHT BLACK	XS/S	37/39	3	BG175038
PRO LIGHT BLACK	S/M	40/41	3	BG175040
PRO LIGHT BLACK	M/L	41/43	3	BG175042
PRO LIGHT BLACK	L/XL	44/45	3	BG175044
PRO LIGHT BLACK	XL/XXL	46/47	3	BG175046
PRO LIGHT BLACK/BLUE	XS/S	37/39	3	BG172038
PRO LIGHT BLACK/BLUE	S/M	40/41	3	BG172040
PRO LIGHT BLACK/BLUE	M/L	41/43	3	BG172042
PRO LIGHT BLACK/BLUE	L/XL	44/45	3	BG172044
PRO LIGHT BLACK/YELLOW	XS/S	37/39	3	BG171038
PRO LIGHT BLACK/YELLOW	S/M	40/41	3	BG171040
PRO LIGHT BLACK/YELLOW	M/L	41/43	3	BG171042
PRO LIGHT BLACK/YELLOW	L/XL	44/45	3	BG171044

OPTIONAL EBS STRAP

EBS STRAP - PAIR	SIZE	CODE
THOR - ARA - PRO LIGHT	SHORT FIT (XS/S - S/M)	BZ150004
THOR - ARA - PRO LIGHT	REGULAR FIT (S/M - M/L)	BZ150005
THOR - ARA - PRO LIGHT	EXTENDED FIT (M/L - L/XL)	BZ150006



FROG

CRESSI
dive center



A classic in the Cressi range, this has been on the market for many years and has a huge number of appreciators in every corner of the planet.

The fin is made with a skilful combination of a strong copolymer and a soft elastomer, the latter used for the foot pocket, for the side stringers and for some inserts.

The blade originates from the upper part of the foot pocket, with a 20% increase in useful surface area compared to a traditional fin of the same length.

The foot pocket is computer designed and offers great comfort; it guarantees excellent transmission of the leg-fin thrust. The Frog is heavier than the more recently designed equivalent Cressi models. It is this feature that makes it agreeable to whoever uses very thick suits or watertight suits. Anyone who works underwater will appreciate this fin a great deal because it is strong and comfortable, very popular also in diving schools and excellent for rental

COLOURS	SIZE	SIZE EU	PACK	CODE
FROG BLACK	XS/S	36/39	3	BF195038
FROG BLACK	S/M	39/42	3	BF195040
FROG BLACK	M/L	42/45	3	BF195042
FROG BLACK	L/XL	45/47	3	BF195044

FREE FROG



BLACK



BLACK/RED

COLOURS	SIZE	PACK	CODE
FREE FROG BLACK	37/38	3	BR155037
FREE FROG BLACK	39/40	3	BR155039
FREE FROG BLACK	41/42	3	BR155041
FREE FROG BLACK	43/44	3	BR155043
FREE FROG BLACK	45/46	3	BR155045
FREE FROG BLACK/RED	37/38	3	JBR155837
FREE FROG BLACK/RED	39/40	3	JBR155839
FREE FROG BLACK/RED	41/42	3	JBR155841
FREE FROG BLACK/RED	43/44	3	JBR155843
FREE FROG BLACK/RED	45/46	3	JBR155845

GARA MODULAR CARBON MD



FOR ADVANCED FREEDIVING AND SPEARFISHING

- └ INTERCHANGEABLE BLADE
- └ SUPERIOR PERFORMANCE
- └ SUPERIOR COMFORT
- └ SELF ADJUSTING FOOT POCKET



└ CARBON BLADE

Gara Modular's footpocket is wider than the other gara fin models. we suggest to use it with neoprene socks in order to have a proper fit. for use without neoprene socks, we recommend to buy one smaller size.

PRODUCT	SIZE	CODE
GARA MODULAR CARBON MD	38/39	BH109238
GARA MODULAR CARBON MD	40/41	BH109240
GARA MODULAR CARBON MD	42/43	BH109242
GARA MODULAR CARBON MD	44/45	BH109244
GARA MODULAR CARBON MD	46/47	BH109246

NEW INCLUDED GARA MODULAR INSOLE



- └ DOWN-SIZE GARA FINS FOOT POCKETS
- └ PREFORMED INSOLE
- └ EASILY ADJUST SIZE NON-CORROSIVE PLASTIC CONSTRUCTION



The new insole for Gara Modular fins is recommended for use with thin boots in temperate waters, because it improves the kick performance. The semi-rigid material of the insole is completely recycled. The insoles are supplied as a pair (right and left foot) and can be cut into their shape in three different sizes, according to pre-printed guidelines.

PRODUCT	CODE
INSOLE FOR GARA FINS	BZ180022



This fin with interchangeable carbon blade is very lightweight and extremely effective. Ideally suited for advanced free diving and underwater fishing at considerable depths. The blade in directional carbon has a tapered profile to ensure a special degree of reactivity and the efficacy that only composite fibres can attain. Medium hardness makes this fin suitable for all diving activities, including deep diving. The Modular "Self Adjusting Foot Pocket" is moulded in 2 different materials and has an extra soft zone that stretches to improve fit, even when wearing very thick boots. Like all the other fins in the Cressi range, the Gara Modular Carbon MD relies on an industrial production system that ensures extremely high standards of precision and conformity to stringent technical parameters, that could not be achieved with traditional artisan processes. Another significant and exclusive feature of the material used is its great durability and constant efficiency over time: even after intensive and prolonged use, the blade retains its strength and maintains its initial technical characteristics unaltered.

BACK SIDE TRACINA CAMOUFLAGE DARK DIGITAL SPECTER PAT



GARA MODULAR FOOT POCKET

SELF ADJUSTING FOOT POCKET



PRODUCT	SIZE	CODE
GARA MODULAR FOOT POCKET	38/39	BH005038
GARA MODULAR FOOT POCKET	40/41	BH005040
GARA MODULAR FOOT POCKET	42/43	BH005042
GARA MODULAR FOOT POCKET	44/45	BH005044
GARA MODULAR FOOT POCKET	46/47	BH005046
GARA MODULAR ASSEMBLY KIT		BZ180020

GARA MODULAR BLADES



PRODUCT	CODE
GARA MODULAR CARBON BLADE MD (SINGLE BLADE)	BH060000
GARA MODULAR NERY BLADE (SINGLE BLADE)	BH055100
GARA MODULAR GREEN LD BLADE (SINGLE BLADE)	BH059810
GARA MODULAR BLACK BLADE (SINGLE BLADE)	BH055000

GARA MODULAR NERY



- ▣ INTERCHANGEABLE BLADE
- ▣ SUPERIOR PERFORMANCE
- ▣ SUPERIOR COMFORT
- ▣ SELF ADJUSTING FOOT POCKET



▣ SOFTER LD BLADE

Cullmanbery
-126m



COMPLETE FREEDIVING RANGE

Cullmanbery
-126m



Gara Modular's footpocket is wider than the other gara fin models. we suggest to use it with neoprene socks in order to have a proper fit. for use without neoprene socks, we recommend to buy one smaller size.

PRODUCT	SIZE	PACK	CODE
GARA MODULAR NERY	38/39	3	BH105138
GARA MODULAR NERY	40/41	3	BH105140
GARA MODULAR NERY	42/43	3	BH105142
GARA MODULAR NERY	44/45	3	BH105144
GARA MODULAR NERY	46/47	3	BH105146

NEW INCLUDED GARA MODULAR INSOLE



- ▣ DOWN-SIZE GARA FINS FOOT POCKETS
- ▣ PREFORMED INSOLE
- ▣ EASILY ADJUST SIZE
- ▣ NON-CORROSIVE PLASTIC CONSTRUCTION



The new insole for Gara Modular fins is recommended for use with thin boots in temperate waters, because it improves the kick performance. The semi-rigid material of the insole is completely recycled. The insoles are supplied as a pair (right and left foot) and can be cut into their shape in three different sizes, according to pre-printed guidelines.



PRODUCT	CODE
INSOLE FOR GARA FINS	BZ180022

GARA MODULAR LD

LONG DISTANCE - SOFTER THERMOPLASTIC BLADE
MINIMUM EFFORT »» MAXIMUM POWER TRANSFER



- INTERCHANGEABLE BLADE
- SUPERIOR PERFORMANCE
- SUPERIOR COMFORT
- SELF ADJUSTING FOOT POCKET



GREEN CAMOU
BLADE



Gara Modular's footpocket is wider than the other gara fin models. we suggest to use it with neoprene socks in order to have a proper fit. for use without neoprene socks, we recommend to buy one smaller size.

PRODUCT	SIZE	PACK	CODE
GARA MODULAR LD	38/39	3	BH109838
GARA MODULAR LD	40/41	3	BH109840
GARA MODULAR LD	42/43	3	BH109842
GARA MODULAR LD	44/45	3	BH109844
GARA MODULAR LD	46/47	3	BH109846

TOTAL LENGHT

SIZE	CM	INCH
38/39 (5/6)	85,00	33,50
40/41 (7/8)	86,00	33,90
42/43 (8/9)	88,00	34,60
44/45 (10/11)	89,50	35,20
46/47 (12/13)	90,50	35,60

BLADE LENGHT

SIZE	CM	INCH
38/39 (5/6)	76,00	29,90
40/41 (7/8)	76,00	29,90
42/43 (8/9)	76,00	29,90
44/45 (10/11)	76,00	29,90
46/47 (12/13)	76,00	29,90

MAX WIDTH

SIZE	CM	INCH
38/39 (5/6)	21,50	8,50
40/41 (7/8)	21,50	8,50
42/43 (8/9)	21,50	8,50
44/45 (10/11)	21,50	8,50
46/47 (12/13)	21,50	8,50

SINGLE FIN WEIGHT

SIZE	GR	LB
38/39 (5/6)	890	1,96
40/41 (7/8)	940	2,07
42/43 (8/9)	990	2,18
44/45 (10/11)	1040	2,29
46/47 (12/13)	1135	2,50

NEW INCLUDED GARA MODULAR INSOLE



- DOWN-SIZE GARA FINS FOOT POCKETS
- PREFORMED INSOLE
- EASILY ADJUST SIZE
- NON-CORROSIVE PLASTIC CONSTRUCTION

The new insole for Gara Modular fins is recommended for use with thin boots in temperate waters, because it improves the kick performance. The semi-rigid material of the insole is completely recycled. The insoles are supplied as a pair (right and left foot) and can be cut into their shape in three different sizes, according to pre-printed guidelines.

PRODUCT	CODE
INSOLE FOR GARA FINS	BZ180022

GARA MODULAR



- INTERCHANGEABLE BLADE
- SUPERIOR PERFORMANCE
- SUPERIOR COMFORT
- SELF ADJUSTING FOOT POCKET



REGULAR
STIFFNESS
BLADE

Gara Modular's footpocket is wider than the other gara fin models. we suggest to use it with neoprene socks in order to have a proper fit. for use without neoprene socks, we recommend to buy one smaller size.

PRODUCT	SIZE	PACK	CODE
GARA MODULAR BLACK	38/39	3	BH105038
GARA MODULAR BLACK	40/41	3	BH105040
GARA MODULAR BLACK	42/43	3	BH105042
GARA MODULAR BLACK	44/45	3	BH105044
GARA MODULAR BLACK	46/47	3	BH105046

NEW INCLUDED GARA MODULAR INSOLE



- DOWN-SIZE GARA FINS FOOT POCKETS
- PREFORMED INSOLE
- EASILY ADJUST SIZE
- NON-CORROSIVE PLASTIC CONSTRUCTION



The new insole for Gara Modular fins is recommended for use with thin boots in temperate waters, because it improves the kick performance. The semi-rigid material of the insole is completely recycled. The insoles are supplied as a pair (right and left foot) and can be cut into their shape in three different sizes, according to pre-printed guidelines.

PRODUCT	CODE
INSOLE FOR GARA FINS	BZ180022



CRESSI introduces its GARA MODULAR long Blade/Footpocket system. The GARA MODULAR system makes this a perfect choice for deep freediving and spearfishing for divers of all levels.

The modular design lets the user replace/interchange blades for specific diving purposes, which make the perfect fin to grow with, as the diver can change blades as the divers skills increase.

Any standard Fiberglass or Carbon Fiber long blade will interchange in minutes without any modifications to either.

The self adjusting footpocket is constructed with the most modern multi compound joining process to deliver a footpocket that can offer comfort and suppleness around the foot where desired and yet have stiffer compounds under the footpocket and heel area where power transfer takes place. The angle of the blade provides the ultimate in efficiency during the kick cycle requiring less energy to load the blade. Can be comfortably worn with or without neoprene socks.

The footpocket is available separately for the user to install any standard aftermarket angled or straight blade assemblies.

The footpocket is constructed with the most modern multi compound joining process to deliver a footpocket

that can offer comfort and suppleness around the foot where desired and yet have stiffer compounds under the footpocket

and heel area where power transfer takes place, and the self adjusting foot pocket expands to be comfortable with or without socks. The

Cressi modular blade is available separately for the user to install in almost any standard angled footpocket assembly either for an upgrade or replacement.

TOTAL LENGHT

SIZE	CM	INCH
38/39 (5/6)	87,00	34,28
40/41 (7/8)	88,00	34,67
42/43 (8/9)	90,00	35,46
44/45 (10/11)	91,50	36,05
46/47 (12/13)	92,50	36,45

BLADE LENGHT

SIZE	CM	INCH
38/39 (5/6)	78,00	30,73
40/41 (7/8)	78,00	30,73
42/43 (8/9)	78,00	30,73
44/45 (10/11)	78,00	30,73
46/47 (12/13)	78,00	30,73

MAX WIDTH

SIZE	CM	INCH
38/39 (5/6)	21,50	8,50
40/41 (7/8)	21,50	8,50
42/43 (8/9)	21,50	8,50
44/45 (10/11)	21,50	8,50
46/47 (12/13)	21,50	8,50

SINGLE FIN WEIGHT

SIZE	GR	LB
38/39 (5/6)	920	2,03
40/41 (7/8)	970	2,14
42/43 (8/9)	1020	2,25
44/45 (10/11)	1070	2,36
46/47 (12/13)	1165	2,57

GARA 3000 LD

SOFTER LONG BLADE FOR EASE OF USE!



- └ LONG DISTANCE
- └ SUPERIOR PERFORMANCE
- └ SUPERIOR COMFORT



└ SOFT BLADE

PRODUCT	SIZE	PACK	CODE
GARA 3000 LD SILVER	40/41	3	BH135140
GARA 3000 LD SILVER	42/43	3	BH135142
GARA 3000 LD SILVER	44/45	3	BH135144
GARA 3000 LD SILVER	46/47	3	BH135146

GARA 3000 LD is CRESSI's entry-level long blade fin designed with softer blades, which make the GARA 3000 a perfect choice for the beginning diver or those not familiar using long blade fins. The GARA 3000 is constructed with durability in mind and long soft plastic blades that can effectively transfer power with minimum effort, which make this fin very comfortable and easy on the legs for the beginner or during long duration dives. The GARA 3000 is an extremely comfortable and is a full footpocket style fin. This fin is also constructed using CRESSI's unique three material molding process where different compounds are bonded together to provide flexibility in the foot area and while being able to deliver power thru the blade due to the stiffness that the multi compound molding process can provide. Can comfortably be worn with or without neoprene socks.

TECHNICAL FEATURES

- Durable construction designed to take abuse
- Soft long blade for ease of use
- Full footpocket for comfort
- Long blade for efficiency

TOTAL LENGHT

SIZE	CM	INCH
40/41 (7/8)	87,00	34.28
42/43 (8/9)	88,50	34.87
44/45 (10/11)	90,50	35.66
46/47 (12/13)	92,50	36.45

BLADE LENGHT

SIZE	CM	INCH
40/41 (7/8)	69,50	27.38
42/43 (8/9)	70,50	27.78
44/45 (10/11)	71,50	28.17
46/47 (12/13)	72,50	28.57

MAX WIDTH

SIZE	CM	INCH
40/41 (7/8)	21,00	8.27
42/43 (8/9)	21,00	8.27
44/45 (10/11)	21,50	8.47
46/47 (12/13)	22,50	8.87

SINGLE FIN WEIGHT

SIZE	GR	LB
40/41 (7/8)	925	2.04
42/43 (8/9)	980	2.16
44/45 (10/11)	1070	2.36
46/47 (12/13)	1165	2.57

GARA 2000 HF

STIFF LONG BLADE DESIGNED FOR MAXIMUM POWER!



- HIGH FREQUENCY
- SUPERIOR PERFORMANCE
- SUPERIOR COMFORT



GARA 2000 HF is a staple in the diving industry, and is the first fin in the industry to be manufactured using a three material molding process. Due to its lightweight and durability, it is an excellent choice for those looking for a fin that can provide the ultimate in performance while deep freediving and spearfishing, and those looking for obtaining maximum depths. The GARA 2000 has the stiffest blade in the CRESSI line and is an extremely comfortable full footpocket style fin, with long firm blades with built in stringers and runners to effectively direct water flow down the blade aiding in efficiency. This fin is constructed using multiple compounds bonded together to provide comfort and suppleness in the foot area and strength and rigidity in the heel and blade area. Can comfortably be worn with or without neoprene socks.

TECHNICAL FEATURES

- Stiff Long Blade designed for maximum depths
- Full footpocket for comfort
- Long blade for efficiency

TOTAL LENGTH

SIZE	CM	INCH
40/41 (7/8)	84.50	33.29
42/43 (8/9)	86.00	33.88
44/45 (10/11)	87.50	34.48
46/47 (12/13)	89.00	35.07

BLADE LENGTH

SIZE	CM	INCH
40/41 (7/8)	66.00	26.00
42/43 (8/9)	66.00	26.00
44/45 (10/11)	67.50	26.60
46/47 (12/13)	67.50	26.60

MAX WIDTH

SIZE	CM	INCH
40/41 (7/8)	21.50	8.47
42/43 (8/9)	21.50	8.47
44/45 (10/11)	22.00	8.67
46/47 (12/13)	22.30	8.79

SINGLE FIN WEIGHT

SIZE	GR	LB
40/41 (7/8)	790	1.74
42/43 (8/9)	895	1.97
44/45 (10/11)	970	2.14
46/47 (12/13)	1030	2.27

PRODUCT	SIZE	PACK	CODE
GARA 2000 HF BLACK	40/41	3	BH115040
GARA 2000 HF BLACK	42/43	3	BH115042
GARA 2000 HF BLACK	44/45	3	BH115044
GARA 2000 HF BLACK	46/47	3	BH115046

GARA PROFESSIONAL LD

LONG DISTANCE



- BLADE DESIGNED TO RUN OVER THE FOOTPOCKET FOR EASE OF USE
- THERMO-RUBBER SOLES FOR EXTRA GRIP ON WET SURFACES



PRODUCT	SIZE	PACK	CODE
GARA PROFESSIONAL LD	40/41	3	BH145140
GARA PROFESSIONAL LD	42/43	3	BH145142
GARA PROFESSIONAL LD	44/45	3	BH145144
GARA PROFESSIONAL LD	46/47	3	BH145146

The Gara Professional LD is a high performance fin, requiring minimum effort to load the long blades. They are more forgiving than other long blade fins for untrained legs, making this an excellent choice for deep free divers and spearfishers of all levels. They are ideal for long distance swimming, while ultimately providing the power and efficiency needed for deep free-diving and spearfishing. Due to the multi compound bonding process used during the manufacturing process, the Gara Pro LD is an exceptionally soft full footpocket style fin, which provides comfort during prolonged use on those long days in the water. Gara Pro LD delivers maximum power with minimum energy through its long firm blade that runs over the footpocket. Can comfortably be worn with or without neoprene socks.

TOTAL LENGTH

SIZE	CM	INCH
40/41 (7/8)	87.00	34.28
42/43 (8/9)	89.00	35.07
44/45 (10/11)	90.00	35.46
46/47 (12/13)	91.50	36.05

BLADE LENGTH

SIZE	CM	INCH
40/41 (7/8)	73.00	28.76
42/43 (8/9)	75.00	29.55
44/45 (10/11)	75.00	29.55
46/47 (12/13)	77.00	30.34

MAX WIDTH

SIZE	CM	INCH
40/41 (7/8)	22.00	8.67
42/43 (8/9)	22.50	8.87
44/45 (10/11)	23.30	9.18
46/47 (12/13)	24.20	9.53

SINGLE FIN WEIGHT

SIZE	GR	LB
40/41 (7/8)	890	1.96
42/43 (8/9)	960	2.12
44/45 (10/11)	990	2.18
46/47 (12/13)	1055	2.33

REACTION PRO

MADE IN ITALY

— SUPERIOR PERFORMANCE



BLUE/AZURE



BLACK/SILVER



YELLOW/SILVER

COLOURS	SIZE	PACK	CODE
REACTION PRO BLUE/AZURE	36/37	3	BG192036
REACTION PRO BLUE/AZURE	38/39	3	BG192038
REACTION PRO BLUE/AZURE	40/41	3	BG192040
REACTION PRO BLUE/AZURE	42/43	3	BG192042
REACTION PRO BLUE/AZURE	44/45	3	BG192044
REACTION PRO BLUE/AZURE	46/47	3	BG192046
REACTION PRO BLACK/SILVER	36/37	3	BG195036
REACTION PRO BLACK/SILVER	38/39	3	BG195038
REACTION PRO BLACK/SILVER	40/41	3	BG195040
REACTION PRO BLACK/SILVER	42/43	3	BG195042
REACTION PRO BLACK/SILVER	44/45	3	BG195044
REACTION PRO BLACK/SILVER	46/47	3	BG195046
REACTION PRO YELLOW/SILVER	36/37	3	BG191036
REACTION PRO YELLOW/SILVER	38/39	3	BG191038
REACTION PRO YELLOW/SILVER	40/41	3	BG191040
REACTION PRO YELLOW/SILVER	42/43	3	BG191042
REACTION PRO YELLOW/SILVER	44/45	3	BG191044
REACTION PRO YELLOW/SILVER	46/47	3	BG191046

REACTION PRO is a great all around fin for scuba, snorkeling and freediving. The REACTION PRO is a full footpocket style fin, with a longer blade and built in runners to effectively direct water flow down the blade. REACTION PRO is constructed using multiple materials bonded together with a patented three material molding process to provide comfort and suppleness in the foot area and strength and rigidity in the heel and blade area, where the foot pocket is beneath the blade for added power and efficiency. The soles are completely covered in thermo-rubber to give them exceptional grip on boat decks. Can comfortably be worn with or without neoprene socks.

TECHNICAL FEATURES

- Full footpocket for comfort
- Long blade for efficiency
- Thermo-Rubber soles for extra grip on wet surfaces

TOTAL LENGTH

SIZE	CM	INCH
36/37 (3/4)	60,00	23,64
38/39 (5/6)	62,00	24,43
40/41 (7/8)	64,00	25,22
42/43 (8/9)	66,50	26,20
44/45 (10/11)	68,00	26,79
46/47 (12/13)	70,00	27,58

BLADE LENGTH

SIZE	CM	INCH
36/37 (3/4)	47,50	18,72
38/39 (5/6)	49,50	19,50
40/41 (7/8)	50,00	19,70
42/43 (8/9)	52,00	20,49
44/45 (10/11)	54,50	21,47
46/47 (12/13)	55,50	21,87

MAX WIDTH

SIZE	CM	INCH
36/37 (3/4)	20,30	8,00
38/39 (5/6)	21,00	8,27
40/41 (7/8)	21,50	8,47
42/43 (8/9)	22,50	8,87
44/45 (10/11)	23,00	9,06
46/47 (12/13)	23,70	9,34

SINGLE FIN WEIGHT

SIZE	GR	LBS
36/37 (3/4)	625	1,38
38/39 (5/6)	710	1,57
40/41 (7/8)	765	1,69
42/43 (8/9)	830	1,83
44/45 (10/11)	880	1,94
46/47 (12/13)	935	2,06

PRO STAR

MADE IN
ITALY

FINS SWIMMING



COLOURS	SIZE	PACK	CODE
PRO STAR BLACK	37/38	4	BG185037
PRO STAR BLACK	39/40	4	BG185039
PRO STAR BLACK	41/42	4	BG185041
PRO STAR BLACK	43/44	4	BG185043
PRO STAR BLACK	45/46	4	BG185045
PRO STAR YELLOW	37/38	4	BG181037
PRO STAR YELLOW	39/40	4	BG181039
PRO STAR YELLOW	41/42	4	BG181041
PRO STAR YELLOW	43/44	4	BG181043
PRO STAR YELLOW	45/46	4	BG181045

PRO STAR is yet another versatile fin in the CRESSI line and is an exceptional choice for Scuba, Snorkeling and Freediving. Inspired by the PRO LIGHT, The PRO STAR is a lightweight and comfortable full footpocket style fin. For power transference, it incorporates the blade beneath the footpocket and the angle of the blade provides the ultimate in efficiency during the kick cycle requiring less energy to load the blade. This fin is constructed using multiple compounds bonded together to provide comfort around the foot, yet strong enough to transfer strength where needed. Can comfortably be worn with or without neoprene socks.

TECHNICAL FEATURES

- Full footpocket for comfort
- Long blade for efficiency

TOTAL LENGTH

SIZE	CM	INCH
37/38 (4/5)	60,00	23,64
39/40 (5,5/6,5)	62,50	24,63
41/42 (7/8)	64,50	25,41
43/44 (8,5/9,5)	66,50	26,20
45/46 (10/11)	68,50	26,99

BLADE LENGTH

SIZE	CM	INCH
37/38 (4/5)	50,00	19,70
39/40 (5,5/6,5)	50,50	19,90
41/42 (7/8)	52,00	20,49
43/44 (8,5/9,5)	54,50	21,47
45/46 (10/11)	56,50	22,26

MAX WIDTH

SIZE	CM	INCH
37/38 (4/5)	20,00	7,88
39/40 (5,5/6,5)	20,50	8,08
41/42 (7/8)	21,00	8,27
43/44 (8,5/9,5)	21,50	8,47
45/46 (10/11)	22,00	8,67

SINGLE FIN WEIGHT

SIZE	GR	LB
37/38 (4/5)	575	1,27
39/40 (5,5/6,5)	615	1,36
41/42 (7/8)	645	1,42
43/44 (8,5/9,5)	710	1,57
45/46 (10/11)	790	1,74

PLUMA

MADE IN
ITALY

- LONG BLADE
- BELOW BLADE FOOT POCKET



This high-tech fin designed specifically for snorkeling benefits from the best technologies used in free diving and scuba diving. Cressi's unique molding process also allows for the use of three separate materials to create a highly-responsive blade. Now, snorkelers can power through current and enjoy hours on the water without undue muscle strain. The Pluma's computer-designed foot pocket provides excellent power transmission and unparalleled comfort.

TECHNICAL FEATURES

- Patented Cressi molding technology used to create lightweight, responsive blade
- Computer designed foot pocket with stiff base better transmits power down the blade
- Soft thermo-rubber foot pocket material is comfortable for extended wear
- Lightweight polypropylene blade is easy to pack
- Blade ribs provide precise flex control for maximum thrust
- Excellent value



BLUE/AZURE



BLACK/SILVER



CLEAR/PINK

COLOURS	SIZE	PACK	CODE
PLUMA BLUE/AZURE	33/34	6	CA172033
PLUMA BLUE/AZURE	35/36	6	CA172035
PLUMA BLUE/AZURE	37/38	6	CA172037
PLUMA BLUE/AZURE	39/40	6	CA172039
PLUMA BLUE/AZURE	41/42	6	CA172041
PLUMA BLUE/AZURE	43/44	6	CA172043
PLUMA BLUE/AZURE	45/46	6	CA172045
PLUMA BLACK/SILVER	35/36	6	CA175035
PLUMA BLACK/SILVER	37/38	6	CA175037
PLUMA BLACK/SILVER	39/40	6	CA175039
PLUMA BLACK/SILVER	41/42	6	CA175041
PLUMA BLACK/SILVER	43/44	6	CA175043
PLUMA BLACK/SILVER	45/46	6	CA175045
PLUMA CLEAR/PINK	33/34	6	CA176433
PLUMA CLEAR/PINK	35/36	6	CA176435
PLUMA CLEAR/PINK	37/38	6	CA176437
PLUMA CLEAR/PINK	39/40	6	CA176439

AGUA

- LONG BLADE
- ABOVE BLADE FOOT POCKET
- SELF ADJUSTING FOOT POCKET



Agua is a very easy fin to use, and doesn't require any special athletic or water-sport abilities, yet it still delivers excellent performance without tiring your feet. Thanks to the latest technology and Cressi's experience in developing these products, we've been able to markedly decrease the weight of this fin compared to others in its category, while still preserving excellent responsiveness. The foot pocket features the original Self Adjusting Foot Pocket system, which thanks to the special softness and elasticity of the blends makes for a consistently soft and adherent fit.

KID



AQUAMARINE



PINK

ADULT



BLACK



BLUE



YELLOW



AQUAMARINE



PINK

NEW

KID SIZE!

COLOURS	SIZE	PACK	CODE
AGUA KID PINK	31/32	6	CA204031
AGUA KID PINK	33/34	6	CA204033
AGUA KID AQUAMARINE	31/32	6	CA206331
AGUA KID AQUAMARINE	33/34	6	CA206333

ADULT SIZE

COLOURS	SIZE	PACK	CODE
AGUA BLACK	35/36	6	CA205035
AGUA BLACK	37/38	6	CA205037
AGUA BLACK	39/40	6	CA205039
AGUA BLACK	41/42	6	CA205041
AGUA BLACK	43/44	6	CA205043
AGUA BLACK	45/46	6	CA205045
AGUA BLUE	35/36	6	CA206235
AGUA BLUE	37/38	6	CA206237
AGUA BLUE	39/40	6	CA206239
AGUA BLUE	41/42	6	CA206241
AGUA BLUE	43/44	6	CA206243
AGUA BLUE	45/46	6	CA206245
AGUA YELLOW	35/36	6	CA201035
AGUA YELLOW	37/38	6	CA201037
AGUA YELLOW	39/40	6	CA201039
AGUA YELLOW	41/42	6	CA201041
AGUA YELLOW	43/44	6	CA201043
AGUA YELLOW	45/46	6	CA201045
AGUA AQUAMARINE	35/36	6	CA206335
AGUA AQUAMARINE	37/38	6	CA206337
AGUA AQUAMARINE	39/40	6	CA206339
AGUA AQUAMARINE	41/42	6	CA206341
AGUA AQUAMARINE	43/44	6	CA206343
AGUA AQUAMARINE	45/46	6	CA206345
N AGUA PINK	35/36	6	CA206435
N AGUA PINK	37/38	6	CA206437
N AGUA PINK	39/40	6	CA206439

RONDINELLA

MADE IN ITALY

- LONG BLADE
- ABOVE BLADE FOOT POCKET
- FINS SWIMMING

**KID
SIZE!**

COLOURS	SIZE	PACK	CODE
RONDINELLA YELLOW	29/30	6	CA181029
RONDINELLA YELLOW	31/32	6	CA181031
RONDINELLA YELLOW	33/34	6	CA181033
RONDINELLA BLUE	29/30	6	CA182029
RONDINELLA BLUE	31/32	6	CA182031
RONDINELLA BLUE	33/34	6	CA182033
RONDINELLA AQUAMARINE	29/30	6	CA186329
RONDINELLA AQUAMARINE	31/32	6	CA186331
RONDINELLA AQUAMARINE	33/34	6	CA186333

**ADULT
SIZE**

COLOURS	SIZE	PACK	CODE
RONDINELLA YELLOW	35/36	6	CA181035
RONDINELLA YELLOW	37/38	6	CA181037
RONDINELLA YELLOW	39/40	6	CA181039
RONDINELLA YELLOW	41/42	6	CA181041
RONDINELLA YELLOW	43/44	6	CA181043
RONDINELLA YELLOW	45/46	6	CA181045
RONDINELLA BLUE	35/36	6	CA182035
RONDINELLA BLUE	37/38	6	CA182037
RONDINELLA BLUE	39/40	6	CA182039
RONDINELLA BLUE	41/42	6	CA182041
RONDINELLA BLUE	43/44	6	CA182043
RONDINELLA BLUE	45/46	6	CA182045
RONDINELLA BLUE	47/48	6	CA182047
RONDINELLA AQUAMARINE	35/36	6	CA186335
RONDINELLA AQUAMARINE	37/38	6	CA186337
RONDINELLA AQUAMARINE	39/40	6	CA186339
RONDINELLA AQUAMARINE	41/42	6	CA186341
RONDINELLA AQUAMARINE	43/44	6	CA186343
RONDINELLA AQUAMARINE	45/46	6	CA186345
RONDINELLA AQUAMARINE	47/48	6	CA186347

11 of Cressi's fifty-year experience has gone into these fins, which are a modern revival of the successful principles of the glorious light blue rubber Rondine fins. The blade is made from light and at the same time reactive polypropylene and during moulding is coalesced with a soft, flexible thermo-rubber (elastomer), used for the foot pocket, for the frames and for some inserts. This mix makes the Rondinella fins light and powerful: they are easy to use, not too demanding, and perform generously at the same time. The computer-designed foot is enveloping and anatomical, making it easy to put them on and perfect for extended use. Rondinella fins are perfect for snorkelling, free diving, and long swims.



YELLOW



BLUE



AQUAMARINE

CLIO



- LONG BLADE
- ABOVE BLADE FOOT POCKET



**KID
SIZE!**

COLOURS	SIZE	PACK	CODE
CLIO YELLOW	27/29	6	CA101027
CLIO YELLOW	30/32	6	CA101030
CLIO YELLOW	33/34	6	CA101033
CLIO BLUE	27/29	6	CA102027
CLIO BLUE	30/32	6	CA102030
CLIO BLUE	33/34	6	CA102033

**ADULT
SIZE**

COLOURS	SIZE	PACK	CODE
CLIO YELLOW	35/36	6	CA101035
CLIO YELLOW	37/38	6	CA101037
CLIO YELLOW	39/40	6	CA101039
CLIO YELLOW	41/42	6	CA101041
CLIO YELLOW	43/44	6	CA101043
CLIO YELLOW	45/46	6	CA101045
CLIO BLUE	35/36	6	CA102035
CLIO BLUE	37/38	6	CA102037
CLIO BLUE	39/40	6	CA102039
CLIO BLUE	41/42	6	CA102041
CLIO BLUE	43/44	6	CA102043
CLIO BLUE	45/46	6	CA102045
CLIO BLUE	47/48	6	CA102047
CLIO BLACK	37/38	6	CA105037
CLIO BLACK	39/40	6	CA105039
CLIO BLACK	41/42	6	CA105041
CLIO BLACK	43/44	6	CA105043
CLIO BLACK	45/46	6	CA105045
CLIO BLACK	47/48	6	CA105047

Simple to use and highly durable, the Clio is a favorite snorkel fin for anyone on a budget. It combines a responsive blade and soft, easy-to-don foot pocket and works well for all ages. The Clio's great value also makes it a good choice for dive schools and rental departments.

TECHNICAL FEATURES

- Responsive blade delivers good power with any kicking style
- Supple, elastomer foot pocket is easy to slip on and off
- Durable and economical, ideal for rental departments

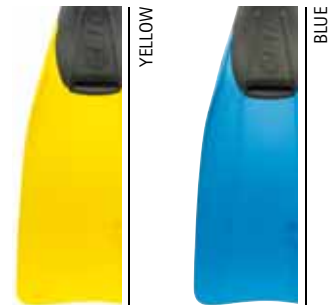

PALAU

ADJUSTABLE FINS

- SUPERIOR COMFORT
- LONG BLADE
- BELOW BLADE FOOT POCKET



These open heel snorkel fins are made for use with bare feet and provide outstanding comfort and versatility. The open-heel design means each fin can accommodate a wider range of sizes, so family members or friends can share equipment more easily. It also allows dive schools or rental departments to stock fewer sizes while providing very high-quality fins to customers. The Palau's blade delivers excellent thrust with a modest kicking effort.

TECHNICAL FEATURES

- Open heel foot pocket designed for bare feet
- Soft elastomer material delivers outstanding comfort
- Ideal for sharing among family and friends or for rental departments
- Easy-kicking blade responds well to any kicking style
- Blade extends from the top of the foot pocket for maximum surface area
- 5 fin sizes cover shoe sizes from 32 to 47 (European).



BLUE/AZURE



BLACK/YELLOW



BLACK/PINK

COLOURS	SIZE	SIZE EU	PACK	CODE
PALAU BLUE/AZURE	KID	29/32	6	CA112029
PALAU BLUE/AZURE	XXS/XS	32/35	6	CA112032
PALAU BLUE/AZURE	XS/S	35/38	6	CA112035
PALAU BLUE/AZURE	S/M	38/41	6	CA112038
PALAU BLUE/AZURE	M/L	41/44	6	CA112041
PALAU BLUE/AZURE	L/XL	44/47	6	CA112044
PALAU BLACK/YELLOW	XXS/XS	32/35	6	CA115132
PALAU BLACK/YELLOW	XS/S	35/38	6	CA115135
PALAU BLACK/YELLOW	S/M	38/41	6	CA115138
PALAU BLACK/YELLOW	M/L	41/44	6	CA115141
PALAU BLACK/YELLOW	L/XL	44/47	6	CA115144
PALAU WHITE/PINK	KID	29/32	6	CA115429
PALAU WHITE/PINK	XXS/XS	32/35	6	CA115432
PALAU BLACK/PINK	XS/S	35/38	6	CA115435
PALAU BLACK/PINK	S/M	38/41	6	CA115438

PALAU SAF

IDEAL FOR SWIM AND SNORKELING
SHORT ADJUSTABLE FINS

- ▣ SUPERIOR COMFORT
- ▣ SHORT BLADE
- ▣ BELOW BLADE FOOT POCKET



BLUE/AZURE



BLACK/YELLOW



BLACK/PINK

COLOURS	SIZE	SIZE EU	PACK	CODE
PALAU SAF BLUE/AZURE	XS/S	35/38	6	CA132035
PALAU SAF BLUE/AZURE	S/M	38/41	6	CA132038
PALAU SAF BLUE/AZURE	M/L	41/44	6	CA132041
PALAU SAF BLUE/AZURE	L/XL	44/47	6	CA132044
PALAU SAF BLACK/YELLOW	XS/S	35/38	6	CA135135
PALAU SAF BLACK/YELLOW	S/M	38/41	6	CA135138
PALAU SAF BLACK/YELLOW	M/L	41/44	6	CA135141
PALAU SAF BLACK/YELLOW	L/XL	44/47	6	CA135144
PALAU SAF BLACK/PINK	XS/S	35/38	6	CA135435
PALAU SAF BLACK/PINK	S/M	38/41	6	CA135438



A true sports fin, the Palau Short Adjustable Fin (SAF) is ideal for active water sports enthusiasts. Short and easy to pack, it's the ultimate travel companion and is suitable for snorkeling, swimming, body surfing, boogie boards and much more. The soft open-heel foot pockets are designed for bare feet and provide a great fit for multiple sizes.

TECHNICAL FEATURES

- Open heel foot pocket designed for bare feet
- Soft elastomer material delivers outstanding comfort
- Ideal for sharing among family and friends or for rental departments
- Short blade
- Blade extends from the top of the foot pocket for maximum surface area

AGUA SHORT

FINS SWIMMING



- SHORT BLADE
- ABOVE BLADE FOOT POCKET
- SELF ADJUSTING FOOT POCKET



Version of the Agua fin with a short blade, developed especially for swimming and snorkeling.



SOFT ULTRA FLEXIBLE MATERIAL

**KID
SIZE!**

COLOURS	SIZE	PACK	CODE
AGUA SHORT BLUE	31/32	6	DP206231
AGUA SHORT BLUE	33/34	6	DP206233

**ADULT
SIZE**

COLOURS	SIZE	PACK	CODE
AGUA SHORT BLUE	35/36	3	DP206235
AGUA SHORT BLUE	37/38	3	DP206237
AGUA SHORT BLUE	39/40	3	DP206239
AGUA SHORT BLUE	41/42	3	DP206241
AGUA SHORT BLUE	43/44	3	DP206243
AGUA SHORT BLUE	45/46	3	DP206245
AGUA SHORT BLUE	47/48	3	DP206247
AGUA SHORT BLACK/SILVER	35/36	3	DP205035
AGUA SHORT BLACK/SILVER	37/38	3	DP205037
AGUA SHORT BLACK/SILVER	39/40	3	DP205039
AGUA SHORT BLACK/SILVER	41/42	3	DP205041
AGUA SHORT BLACK/SILVER	43/44	3	DP205043
AGUA SHORT BLACK/SILVER	45/46	3	DP205045
AGUA SHORT BLACK/SILVER	47/48	3	DP205047



BLUE



BLACK/SILVER



LIGHT

FINS SWIMMING

Cressi
swim

MADE IN
ITALY

- SHORT BLADE
- BELOW BLADE FOOT POCKET



**KID
SIZE!**

COLOURS	SIZE	PACK	CODE
LIGHT WHITE	31/32	3	DP183031
LIGHT WHITE	33/34	3	DP183033
LIGHT BLUE	31/32	3	DP182031
LIGHT BLUE	33/34	3	DP182033

**ADULT
SIZE**

COLOURS	SIZE	PACK	CODE
LIGHT WHITE	35/36	3	DP183035
LIGHT WHITE	37/38	3	DP183037
LIGHT WHITE	39/40	3	DP183039
LIGHT WHITE	41/42	3	DP183041
LIGHT WHITE	43/44	3	DP183043
LIGHT WHITE	45/46	3	DP183045
LIGHT BLUE	35/36	3	DP182035
LIGHT BLUE	37/38	3	DP182037
LIGHT BLUE	39/40	3	DP182039
LIGHT BLUE	41/42	3	DP182041
LIGHT BLUE	43/44	3	DP182043
LIGHT BLUE	45/46	3	DP182045

The Cressi Light are specifically designed for pool use and for swim training, but can also be used adequately for recreational swimming and snorkeling. The short blade is made of a highly reactive and light material which guarantees agile and effective kicking while not tiring out your legs. The length of the blade has been researched and studied by Cressi to ensure perfect muscle training without causing cramps or discomfort. The anatomically designed foot pocket is made from soft rubber elastomers, and it houses the foot with a great deal of comfort, even during long swimming sessions.

WHO IT IS FOR

The Light Fins have been specifically designed for training and to build up muscles, but they can also be used for recreational swimming and snorkeling.



SOFT ULTRA FLEXIBLE
MATERIAL



BLUE



WHITE

MINI LIGHT

KID
SIZE!

- SHORT BLADE
- BELOW BLADE FOOT POCKET



NEW

100% NATURAL RUBBER

SIZE: 25/28 - 29/31



COLOURS	SIZE	PACK	CODE
MINI LIGHT BLUE	25/28	6	DP302025
MINI LIGHT BLUE	29/31	6	DP302029
MINI LIGHT YELLOW	25/28	6	DP301025
MINI LIGHT YELLOW	29/31	6	DP301029
MINI LIGHT ORANGE	25/28	6	DP308525
MINI LIGHT ORANGE	29/31	6	DP308529

MINI BONETE

SHORT ADJUSTABLE FINS

NEW

KID
SIZE!

- ▶ SHORT BLADE
- ▶ ABOVE BLADE FOOT POCKET



COLOURS	SIZE	SIZE EU	PACK	CODE
MINI BONETE BLUE/WHITE	S/M	32/34	6	CA272032
MINI BONETE BLUE/WHITE	L/XL	34/36	6	CA272034
MINI BONETE LILAC/WHITE	S/M	32/34	6	CA274132
MINI BONETE LILAC/WHITE	L/XL	34/36	6	CA274134



CRESSI

S E T S

BUYER'S GUIDE 2019



GARA PROFESSIONAL BAG



SET:

fins GARA PROFESSIONAL LD
+ mask MATRIX
+ snorkel CORSICA

NEW

BAG
 cm 94x17,5x24,5



PRODUCT	SIZE	PACK	CODE
GARA PRO BAG	40/41	3	SE401040
GARA PRO BAG	42/43	3	SE401042
GARA PRO BAG	44/45	3	SE401044
GARA PRO BAG	46/47	3	SE401046

PRO STAR BAG

SET:

fins PRO STAR
+ mask MATRIX
+ snorkel GAMMA



NET BAG



COLOURS	SIZE	PACK	CODE
PRO STAR BAG BLACK	37/38	6	BG189537
PRO STAR BAG BLACK	39/40	6	BG189539
PRO STAR BAG BLACK	41/42	6	BG189541
PRO STAR BAG BLACK	43/44	6	BG189543
PRO STAR BAG BLACK	45/46	6	BG189545

PLUMA BAG

SET:

fins PLUMA

+ mask PERLA

+ snorkel GAMMA



BAG
cm 32x70



PRODUCT	SIZE	PACK	CODE
PLUMA BAG SET	35/36	6	CA179535
PLUMA BAG SET	37/38	6	CA179537
PLUMA BAG SET	39/40	6	CA179539
PLUMA BAG SET	41/42	6	CA179541
PLUMA BAG SET	43/44	6	CA179543
PLUMA BAG SET	45/46	6	CA179545

AGUA BAG

SET:

fins AGUA

+ mask ONDA

+ snorkel MEXICO



NEW

NET BAG
cm 25x65



PRODUCT	SIZE	PACK	CODE
AGUA BAG SET	35/36	6	XCA312035
AGUA BAG SET	37/38	6	XCA312037
AGUA BAG SET	39/40	6	XCA312039
AGUA BAG SET	41/42	6	XCA312041
AGUA BAG SET	43/44	6	XCA312043
AGUA BAG SET	45/46	6	XCA312045

RONDINELLA BAG

SET: fins RONDINELLA + mask ONDA + snorkel GRINGO



NET BAG
cm 25x65



PRODUCT	SIZE	PACK	CODE
RONDINELLA BAG SET	35/36	6	CA189235
RONDINELLA BAG SET	37/38	6	CA189237
RONDINELLA BAG SET	39/40	6	CA189239
RONDINELLA BAG SET	41/42	6	CA189241
RONDINELLA BAG SET	43/44	6	CA189243
RONDINELLA BAG SET	45/46	6	CA189245
RONDINELLA BAG SET	47/48	6	CA189247

RONDINELLA BAG

SET: fins RONDINELLA + mask ONDINA + snorkel MINIGRINGO



NET BAG



PRODUCT	SIZE	PACK	CODE
RONDINELLA BAG SET	31/32	6	CA189231
RONDINELLA BAG SET	33/34	6	CA189233

PALAU BAG

SET: fins PALAU + mask MAREA + snorkel GAMMA



BAG
cm 30x60



COLOURS	SIZE	PACK	CODE
PALAU MAREA BAG SET	XXS/XS (32/35)	6	CA122632
PALAU MAREA BAG SET	XS/S (35/38)	6	CA122635
PALAU MAREA BAG SET	S/M (38/41)	6	CA122638
PALAU MAREA BAG SET	M/L (41/44)	6	CA122641
PALAU MAREA BAG SET	L/XL (44/47)	6	CA122644

MINI PALAU BAG

SET: fins PALAU KID + mask ESTRELLA JR + snorkel TOP COLORAMA



NEW



COLOUR BAG



COLOURS	SIZE	PACK	CODE
MINI PALAU BAG BLUE	29/32	6	CA123029
MINI PALAU BAG BLUE	32/35	6	CA123032
MINI PALAU BAG PINK	29/32	6	CA123129
MINI PALAU BAG PINK	32/35	6	CA123132

FINS BAGS

ADULT



CODE
BZ175003



CODE
BZ175007



CODE
BZ175017

KID



CODE
BZ175030



CODE
BZ175031

MAIN FINS SPARE PARTS

FOR THE FULL LIST,
SEE OUR
SPARE PARTS
CATALOGUE



FINS SPARE PARTS	SIZE	CODE
EBS STRAP SHORT FIT (PAIR) THOR - ARA - PRO LIGHT	SHORT	BZ150004
EBS STRAP REGULAR FIT (PAIR) THOR - ARA - PRO LIGHT	REGULAR	BZ150005
EBS STRAP EXTENDED FIT (PAIR) THOR - ARA - PRO LIGHT	EXTENDED	BZ150006
EBS STRAP SHORT FIT (PAIR) REACTION-FROG PLUS	SHORT	BZ150001
EBS STRAP REGULAR FIT (PAIR) REACTION-FROG PLUS	REGULAR	BZ150002
EBS STRAP EXTENDED FIT (PAIR) REACTION-FROG PLUS	EXTENDED	BZ150003
BUCKLES FOR REACTION/FROG PLUS (PAIR)		BZ170016
BUCKLES FOR THOR/ARA/PRO LIGHT (PAIR)		BZ170015
STRAPS FOR ALL FINS (EXCEPT PALAU/PALAU SAF)		BZ170002
BUCKLES FOR PALAU/PALAU SAF (PAIR)		BZ170004
PALAU STRAPS/PALAU SAF		BZ170003

CRESSI

M A S K S

BUYER'S GUIDE 2019



ZEUS

- U.S. PAT 6272693 B1
- DOUBLE INJECTION TECHNOLOGY
- IDF-TECHNOLOGY INTEGRATED DUAL FRAME
- INCLINED LENSES
- FLEXIBLE BUCKLE
- TEMPERED GLASS

NEW



NEW BUCKLE WITH A LARGER BUTTON



Contemporary
-126m



IRIDIUM LENSES
OPTICAL GLASS UV 420
PROTECTION FILTER

100% HIGH QUALITY SILICONE MATTE COATING

Zeus is the perfect mask for diving. This mask has a particular tapered structure deriving directly from the highly popular Nano-mask patent. The same IDF-INTEGRATED DUAL FRAME TECHNOLOGY SYSTEM allows you to join the silicone skirt to the lens frame without major interruptions of the curvature continuity. The result is a mask with an extremely hydrodynamic shape and, visibility being equal, a significantly smaller size. The field of view obtained is particularly wide, laterally and in the lower zone. Thanks to its matte coating the mask's components all match, enhancing the underwater experience since it prevents reflections in the water that may disturb marine life. The new micrometric adjustable buckles with a larger button allow a more easily regulation also wearing dive gloves. The new strap is made of two different silicone colors.

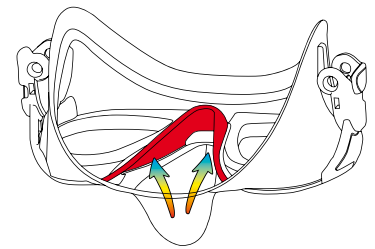
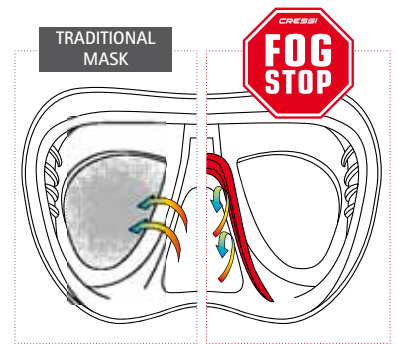

FOG STOP SYSTEM: INNER NOSE POCKET NEW PATENT PENDING

A patented membrane surrounding the inner nose pocket which acts as a barrier and traps any moisture escaping from the diver's nose involuntarily when breathing through the mouth. The result is that not only is the moisture channeled away from the lenses, thus avoiding the fogging up of them, but it also reduces the need to compensate for pressure. To further improve the anti-fog effect, Cressi suggests, the first times that the dive mask is used, to spray some anti-fog solution or to apply some saliva on the inside of the lenses and then to rinse them with water.

COLOURS	PACK	CODE
ZEUS BLACK/GOLD	6	DS475009
ZEUS BLUE NERY	6	DS475550
ZEUS BLACK/BLACK	6	DS475050
ZEUS DARK GREY/BLACK	6	DS475150
ZEUS BLACK/RED	6	DS475058
ZEUS BLACK/SILVER	6	DS475051
ZEUS BLACK/BLACK IRIDIUM	6	DS4750509

AIR CRYSTAL®

BUILT WITH THE NEW IDF TECHNOLOGY INTEGRATED DUAL FRAME

- U.S. PAT 6272693 B1
- DOUBLE INJECTION TECHNOLOGY
- INTEGRATED DUAL FRAME
- TEMPERED GLASS
- MICROMETRIC ADJUSTABLE BUCKLE
- FLEXIBLE BUCKLE
- INCLINED LENSES



COLOURS	PACK	CODE
AIR CLEAR/BLACK/YELLOW	6	DS400010
AIR CLEAR/BLUE/WHITE	6	DS400020
AIR CLEAR/BLACK/PINK	6	DS400040
AIR CLEAR/BLACK/LILAC	6	DS400041
AIR CLEAR/BLACK/BLACK	6	DS400050
AIR CLEAR/BLACK/WHITE	6	DS400060
AIR CLEAR/BLACK/BLUE	6	DS400062
ASSORTED	12	DS400099



100% HIGH QUALITY SOFT SILICONE crystal®

This mask has a particular tapered structure deriving directly from the highly popular Nano-mask patent. THE DUAL INTEGRATED FRAME TECHNOLOGY SYSTEM allows you to join the silicone skirt to the lens frame without major interruptions of the curvature continuity.

The result is a mask with an extremely hydrodynamic shape and, visibility being equal, a significantly smaller size. The field of view obtained is particularly wide, laterally and in the lower zone. The skirt, in the front part, has a structural silicone insert which increases the sealing ability of the mask and creates an exceptionally pleasant chromatic play. Micrometer adjustable buckles.

CRESSI crystal® The Silicone Revolution

CRYSTAL SILICONE® IS AN EXCLUSIVE CRESSI MATERIAL THAT REVOLUTIONIZES SWIM MASK SKIRT CLARITY.

IT OFFERS INCREDIBLY CLEAR VISION AND FEATURES LONG-LASTING ADVANCED TECHNOLOGY COMPONENTS WITHIN THE PURE SILICONE SKIRT WHICH PREVENTS PREMATURE DISCOLORATION, REDUCES FOGGING, AND GUARANTEES MANY YEARS OF CRYSTAL CLEAR VIEWING.



AIR

BUILT WITH THE NEW IDF TECHNOLOGY INTEGRATED DUAL FRAME

- U.S. PAT 6272693 B1
- DOUBLE INJECTION TECHNOLOGY
- INTEGRATED DUAL FRAME
- TEMPERED GLASS
- MICROMETRIC ADJUSTABLE BUCKLE
- FLEXIBLE BUCKLE
- INCLINED LENSES



COLOURS	PACK	CODE
AIR BLUE NERY	6	DS40550
AIR BLACK/BLACK/YELLOW	6	DS405010
AIR BLACK/BLACK/BLACK	6	DS405050
AIR BLACK/BLACK/WHITE	6	DS405060
AIR BLACK/BLACK/BLUE	6	DS405062



100% HIGH QUALITY SOFT SILICONE **BLACK**

This mask has a particular tapered structure deriving directly from the highly popular Nano-mask patent. THE DUAL INTEGRATED FRAME TECHNOLOGY SYSTEM allows you to join the silicone skirt to the lens frame without major interruptions of the curvature continuity. The result is a mask with an extremely hydrodynamic shape and, visibility being equal, a significantly smaller size. The field of view obtained is particularly wide, laterally and in the lower zone. The skirt, in the front part, has a structural silicone insert which increases the sealing ability of the mask and creates an exceptionally pleasant chromatic play. Micrometer adjustable buckles.



CALIBRO

BUILT WITH THE NEW IDF TECHNOLOGY INTEGRATED DUAL FRAME



- U.S. PAT 6272693 B1
- ULTRA LOW VOLUME
- INTEGRATED DUAL FRAME
- TEMPERED GLASS
- MICROMETRIC ADJUSTABLE BUCKLE
- FLEXIBLE BUCKLE



100% HIGH QUALITY SILICONE MATTE COATING

Cressi's next generation diving masks are all equipped with the IDF-INTEGRATED DUAL FRAME TECHNOLOGY which offers exceptional field of view, and the new Calibro is no exception. The mask is designed so that the integrated face and frame allow for an extremely hydrodynamic and compact shape and a particularly wide lens, maintaining the mask extremely close to the face. Cressi's Calibro combines minimal internal volume with a phenomenal field of view due to the raked angle of the frame. The buckles are, as always, directly integrated into the rigid skirt through a solid but flexible rubber attachment that allows you to adjust and place the mouthpiece without shifting the mask. Thanks to its matte coating the mask's components all match, enhancing the underwater experience since it prevents reflections in the water that may disturb marine life. Calibro is the perfect mask for free-diving since it is designed to provide the diver with a feeling of total freedom and comfort.

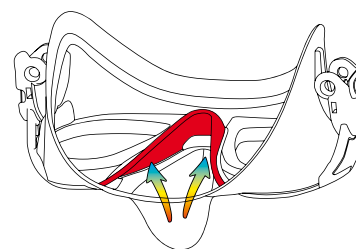
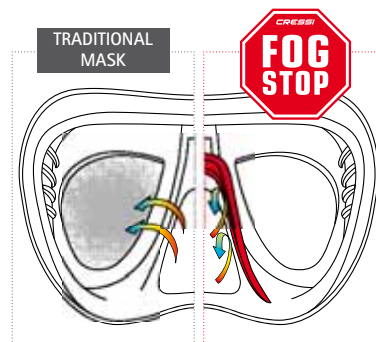

COLOURS	PACK	CODE
CALIBRO CLEAR	6	DS426000
CALIBRO BLUE NERY	6	DS425550
CALIBRO WHITE/PINK	6	DS424030



HD MIRRORED LENSES

COLOURS	PACK	CODE
CALIBRO SF BLACK	6	DS425050
CALIBRO SF GREEN	6	DS429850
CALIBRO SF BLACK HD MIRRORED LENS	6	DS426050



NANO

BUILT WITH THE NEW IDF TECHNOLOGY INTEGRATED DUAL FRAME

- ▣ U.S. PAT 6272693 B1
- ▣ ULTRA LOW VOLUME
- ▣ INTEGRATED DUAL FRAME
- ▣ TEMPERED GLASS
- ▣ MICROMETRIC ADJUSTABLE BUCKLE
- ▣ FLEXIBLE BUCKLE



100% HIGH QUALITY
SOFT SILICONE *crystal*

100% HIGH QUALITY
SOFT SILICONE **BLACK**

Mask for advanced freediving and spearfishing, designed to offer an extremely hydrodynamic and compact shape to help divers cut through the water and aid movements in small spaces. The internal volume is minimal and does not require intentional equalizing. The swiveling buckles feature micrometric regulation. Angled tempered glass lenses. Anatomical strap.

crystal



COLOURS	PACK	CODE
NANO CLEAR/BLUE	6	DS360020
NANO CLEAR/YELLOW	6	DS360010
NANO CLEAR/PINK	6	DS360040
NANO CLEAR/LILAC	6	DS360041
NANO CLEAR/WHITE	6	DS360060



Antony
-1262

HD MIRRORRED LENSES

COLOURS	PACK	CODE
NANO BLACK	6	DS365050
NANO BROWN	6	DS365097
NANO GREEN	6	DS369850
NANO BLUE NERY	6	DS365550
NANO BLACK HD MIRRORRED LENS	6	DS366050



BIG EYES EVOLUTION CRYSTAL®



- └ U.S. PAT 6272693 B1
- └ DOUBLE INJECTION TECHNOLOGY
- └ TEMPERED GLASS
- └ MICROMETRIC ADJUSTABLE BUCKLE
- └ FLEXIBLE BUCKLE
- └ INCLINED LENSES



COLOURS	PACK	CODE
BIG EYES EVOLUTION CRYSTAL CLEAR/YELLOW	6	DS340010
BIG EYES EVOLUTION CRYSTAL CLEAR/BLUE/BLACK	6	DS340025
BIG EYES EVOLUTION CRYSTAL CLEAR/PINK	6	DS340040
BIG EYES EVOLUTION CRYSTAL CLEAR/BLACK	6	DS340060
BIG EYES EVOLUTION CRYSTAL CLEAR/BLUE	6	DS340062

100% HIGH QUALITY SOFT SILICONE crystal

The ultimate in comfort and performance, the Big Eyes Evolution Crystal combines the best of Cressi technologies. Raked lenses, with Cressi's inverted tear-drop shape, are placed close to the eyes for an exceptional field of view, and the Crystal Silicone skirt delivers excellent light transmission while resisting discoloration and fogging. The Crystal Silicone skirt also seals gently against the skin with a very open angle that accommodates a wide range of facial shapes.

TECHNICAL FEATURES

- Raked lenses provide excellent field-of-view
- Inverted tear-drop lenses improve downward visibility for managing BC-mounted gear
- Low internal volume allows for effortless clearing
- Crystal Silicone resists aging and prevents skirt discoloration and fogging
- Ribbed skirt design provides support where needed for a soft, flexible fit
- Micrometric adjustable buckles allow precise headband adjustments
- Swiveling buckles connect to flexible, indestructible elastomer tabs for total durability and comfort
- Accepts optical lenses

OPTICAL LENSES

Possibility of mounting optical lenses
CORRECTION -1.0 > -6.00

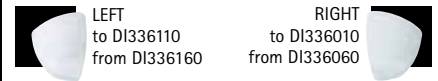

BIG EYES EVOLUTION



- U.S. PAT 6272693 B1
- DOUBLE INJECTION TECHNOLOGY
- TEMPERED GLASS
- MICROMETRIC ADJUSTABLE BUCKLE
- FLEXIBLE BUCKLE
- INCLINED LENSES

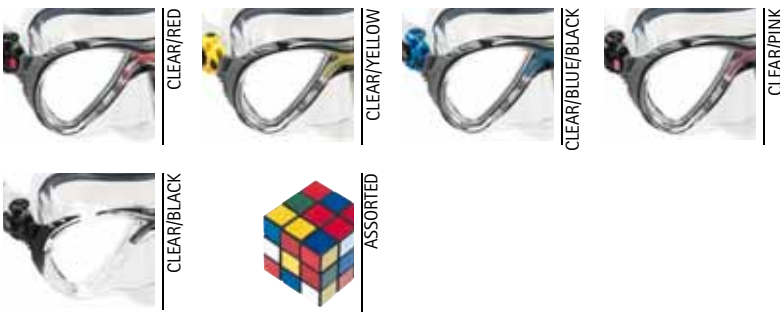

COLOURS	PACK	CODE
BIG EYES EVOLUTION CLEAR/RED	6	DS336080
BIG EYES EVOLUTION CLEAR/YELLOW	6	DS336010
BIG EYES EVOLUTION CLEAR/BLUE/BLACK	6	DS336020
BIG EYES EVOLUTION CLEAR/PINK	6	DS336040
BIG EYES EVOLUTION CLEAR/BLACK	6	DS336060
ASSORTED	12	DS336099



COLOURS	PACK	CODE
BIG EYES EVOLUTION BLACK	6	DS336550
BIG EYES EVOLUTION BLACK HD MIRRORRED LENSES	6	DS336950
BIG EYES EVOLUTION BLACK/BLUE	6	DS336520
BIG EYES EVOLUTION BLACK/YELLOW	6	DS336510

100% HIGH QUALITY
SOFT SILICONE **CLEAR**

100% HIGH QUALITY
SOFT SILICONE **BLACK**

The Big Eyes Evolution's signature inverted tear-drop lenses are raked inward and provide outstanding field of view with very low internal volume. A redesigned skirt now uses internal ribs to provide the ultimate in fit and support. Fully flexible, easy adjust buckles are attached using Cressi's double injection molding technology for both comfort and extreme durability.

TECHNICAL FEATURES

- Raked lenses provide excellent field-of-view
- Inverted tear-drop lenses improve downward visibility for managing BC-mounted gear
- Low internal volume allows for effortless clearing
- Dual-density silicone skirt flexes for a perfect seal along the face and full support around the frame
- Ribbed facial skirt provides support where needed for a soft, flexible fit
- Micrometric adjustable buckles allow precise headband adjustments
- Swiveling buckles connect to flexible, indestructible elastomer tabs for total durability and comfort.
- Accepts optical lenses

OPTICAL LENSES

Possibility of mounting optical lenses
CORRECTION -1.0 > -6.00

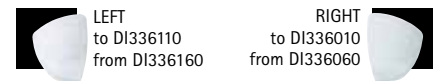

HD MIRRORRED LENSES



HD MIRRORRED LENSES INCREASE THE VISION'S CLEARNESS BY 15%

EYES EVOLUTION CRYSTAL®



- U.S. PAT 6272693 B1
- DOUBLE INJECTION TECHNOLOGY
- TEMPERED GLASS
- MICROMETRIC ADJUSTABLE BUCKLE
- FLEXIBLE BUCKLE
- INCLINED LENSES



100% HIGH QUALITY
SOFT SILICONE *Crystal*

TECHNICAL FEATURES

- Features the same great Cressi exclusive Crystal silicone as manufactured in the Big Eyes Evolution Crystal mask, but with styling and features in a medium size
- Designed for those with a narrow or small face.

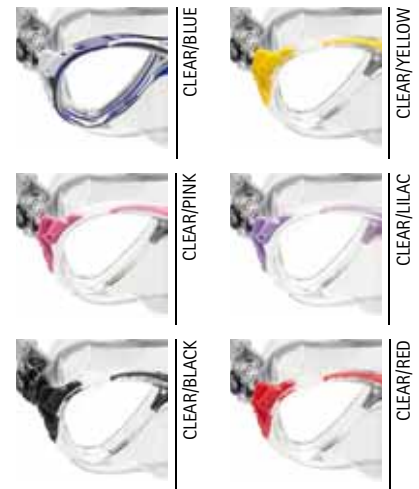

COLOURS	PACK	CODE
EYES EVOLUTION CRYSTAL CLEAR/BLUE	6	DS350020
EYES EVOLUTION CRYSTAL CLEAR/YELLOW	6	DS350010
EYES EVOLUTION CRYSTAL CLEAR/PINK	6	DS350040
EYES EVOLUTION CRYSTAL CLEAR/LILAC	6	DS350041
EYES EVOLUTION CRYSTAL CLEAR/BLACK	6	DS350060
EYES EVOLUTION CRYSTAL CLEAR/RED	6	DS350080

EYES EVOLUTION BLACK



100% HIGH QUALITY
SOFT SILICONE **BLACK**



COLOURS	PACK	CODE
EYES EVOLUTION BLACK/GREEN	6	DS355098
EYES EVOLUTION BLACK	6	DS355050

LIBERTY TRISIDE

- └ 3 LENS PANORAMIC DESIGN
- └ TEMPERED GLASS
- └ MICROMETRIC ADJUSTABLE BUCKLE
- └ FLEXIBLE BUCKLE



COLOURS	PACK	CODE
LIBERTY TRISIDE BLACK/BLUE	6	DS455020
LIBERTY TRISIDE BLACK/BLACK	6	DS455050
LIBERTY TRISIDE CLEAR/YELLOW	6	DS450015

100% HIGH QUALITY
SOFT SILICONE **CLEAR**

100% HIGH QUALITY
SOFT SILICONE **BLACK**



BLACK/BLUE



BLACK/BLACK



CLEAR/YELLOW



MATRIX



- U.S. PAT 6272693 B1
- INCLINED LENSES
- MICROMETRIC ADJUSTABLE BUCKLE
- TEMPERED GLASS



100% HIGH QUALITY
SOFT SILICONE **CLEAR**

100% HIGH QUALITY
SOFT SILICONE **BLACK**

The compact twin-lens Matrix takes the basic design concepts of the Big Eyes Evolution and pushes them to a new level of performance. More pronounced inverted tear-drop shaped lenses, raked inward to sit even closer to the eyes, and a more compact build overall make the Matrix an ideal choice for divers and free divers looking for the biggest view in the smallest package.

TECHNICAL FEATURES

- Raked lenses provide excellent field-of-view
- Extremely low internal volume on par with the best free diving masks
- Silicone skirt shaped to provide a wide sealing surface for a leak-free fit
- Micrometric adjustable buckles allow precise headband adjustments
- Overmolded frame is easy to grip
- Inverted tear-drop lenses improve downward visibility for managing BC-mounted gear



COLOURS	PACK	CODE
MATRIX CLEAR/BLUE	6	DS301020
MATRIX CLEAR/YELLOW	6	DS301010
MATRIX CLEAR/BLACK	6	DS301060
MATRIX CLEAR/AQUAMARINE	6	DS301063
ASSORTED	12	DS301099



COLOURS	PACK	CODE
MATRIX BLACK	6	DS302050
MATRIX GREEN	6	DS309850
MATRIX DIVE CENTER EDITION	6	JDS300058



LINCE



- U.S. PAT 6272693 B1
- INCLINED LENSES
- MICROMETRIC ADJUSTABLE BUCKLE
- TEMPERED GLASS



CLEAR/YELLOW



CLEAR/BLUE



CLEAR/PINK



CLEAR/AQUAMARINE



CLEAR/WHITE/LILAC



ASSORTED

COLOURS	PACK	CODE
LINCE CLEAR/YELLOW	6	DS311010
LINCE CLEAR/BLUE	6	DS311020
LINCE CLEAR/PINK	6	DS311040
LINCE CLEAR/AQUAMARINE	6	DS311063
LINCE CLEAR/WHITE LILAC	6	DS311030
ASSORTED	12	DS311099



BLACK

COLOURS	PACK	CODE
LINCE BLACK	6	DS312050

100% HIGH QUALITY
SOFT SILICONE **CLEAR**

100% HIGH QUALITY
SOFT SILICONE **BLACK**

A trimmed down version of the Matrix, the is a perfect fit for many younger divers or those with narrower faces. The extremely low internal volume makes it comfortable to wear and effortless to clear. Divers and snorkelers alike will appreciate the exceptional field of view offered in this ultra compact mask.

TECHNICAL FEATURES

- Sized for younger divers or those with narrower faces
- Raked lenses provide excellent field-of-view
- Extremely low internal volume on par with the best free diving masks
- Silicone skirt shaped to provide a wide sealing surface for a leak-free fit
- Micrometric adjustable buckles allow precise headband adjustments
- Overmolded frame is easy to grip
- Inverted tear-drop lenses improve downward visibility for managing BC-mounted gear



F1

FRAMELESS COLORAMA DIVE MASK

- └ MICROMETRIC ADJUSTABLE BUCKLE
- └ TEMPERED GLASS



SHINY SILICONE



Frameless masks are loved by many divers for their low-profile and ability to fold flat for easy carrying, even in a BC pocket. Cressi's frameless design bonds a high-grade silicone skirt directly to a single lens for the ultimate in simplicity. The low-internal volume allows for effortless clearing and quick-adjust strap buckles are molded directly into the skirt for a flexible fit and reduced drag. It also represents an unbeatable value, with a cost roughly half that of similar masks.

TECHNICAL FEATURES

- Ultra low-volume, single lens design for excellent field-of-view
- Silicone skirt bonds directly to the lens for lower weight and reduced drag
- Fast-adjust ratcheting strap buckles mounted to skirt
- Supple, high-grade silicone seals gently and securely against the face
- Tempered glass lenses
- Easy-access nose pocket for equalization
- Excellent value

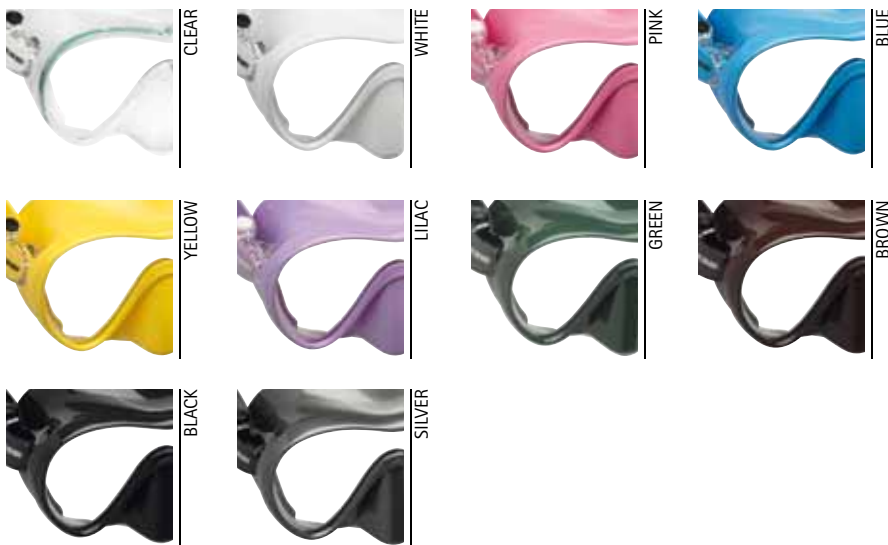

COLOURS	PACK	CODE
F1 BLACK	6	ZDN282000
F1 CLEAR	6	ZDN281000
F1 WHITE	6	ZDN283000
F1 YELLOW	6	ZDN281010
F1 BLUE	6	ZDN281020
F1 PINK	6	ZDN284000
F1 LILAC	6	ZDN284100
F1 GREEN	6	ZDN285000
F1 BROWN	6	ZDN287000
F1 SILVER	6	ZDN281051



F1 SMALL

SMALL FIT MASK

- ▣ MICROMETRIC ADJUSTABLE BUCKLE
- ▣ TEMPERED GLASS



SHINY SILICONE



COLOURS	PACK	CODE
F1 SMALL BLUE	6	ZDN311020
F1 SMALL YELLOW	6	ZDN311010
F1 SMALL LILAC	6	ZDN311041
F1 SMALL PINK	6	ZDN311040



FOCUS



- EASY ADJUSTABLE BUCKLE
- TEMPERED GLASS



CLEAR/PINK



CLEAR/YELLOW



CLEAR/BLUE



CLEAR/BLACK



CLEAR/AQUAMARINE



ASSORTED

COLOURS	PACK	CODE
FOCUS CLEAR/PINK	6	DS241040
FOCUS CLEAR/YELLOW	6	DS241010
FOCUS CLEAR/BLUE	6	DS241020
FOCUS CLEAR/BLACK	6	DS241060
FOCUS CLEAR/AQUAMARINE	6	DS241063
ASSORTED	12	DS241099



BLACK/BLUE



BLACK

COLOURS	PACK	CODE
FOCUS BLACK/BLUE	6	DS242020
FOCUS BLACK	6	DS242050

100% HIGH QUALITY
SOFT SILICONE **CLEAR**

100% HIGH QUALITY
SOFT SILICONE **BLACK**

The ultimate in versatility, this classic mask offers the best fit and performance for the greatest variety of facial shapes. Its low-volume, twin-lens design gives divers and snorkelers a proven combination of size, fit and durability. Lightweight and easy-to-clear it has swiveling, quick-adjust buckles and accepts corrective lenses. It is also an excellent value.

TECHNICAL FEATURES

- Low internal volume allows for effortless clearing
- Lightweight, compact and rugged
- ideal for travel or as a backup mask
- High-grade silicone skirt provides a leak-free seal
- Quick-adjust swivel buckles prevent binding
- Accepts optical lenses

OPTICAL LENSES

Possibility of mounting optical lenses
CORRECTION -1.0 > -8.00



Symmetrical Lenses
to DI240010
from DI240080



BIG EYES



- U.S. PAT 6272693 B1
- INCLINED LENSES
- EASY ADJUSTABLE BUCKLE
- TEMPERED GLASS



CLEAR/BLACK



CLEAR/YELLOW



CLEAR/AZURE



CLEAR/INK BLUE



ASSORTED

COLOURS	PACK	CODE
BIG EYES CLEAR/BLACK	6	DS261060
BIG EYES CLEAR/YELLOW	6	DS261010
BIG EYES CLEAR/AZURE	6	DS261020
BIG EYES CLEAR/INK BLUE	6	DS261062
ASSORTED	12	DS261099



BLACK/BLUE



BLACK

COLOURS	PACK	CODE
BIG EYES BLACK/BLUE	6	DS262020
BIG EYES BLACK	6	DS262050

100% HIGH QUALITY
SOFT SILICONE **CLEAR**

100% HIGH QUALITY
SOFT SILICONE **BLACK**

The mask that began a revolution remains one of the most duplicated designs today. Its inverted tear-drop lens shape and raked lenses provide 30% greater field of view than typical twin-lens masks. The high-grade silicone skirt's unique shape positions the lenses comfortably close to the eyes and provides an excellent seal.

TECHNICAL FEATURES

- Raked lenses provide excellent field-of-view
- Inverted tear-drop lenses improve downward visibility for managing BC-mounted gear
- Low internal volume allows for effortless clearing
- High-grade silicone skirt provides a leak-free seal
- Quick-adjust swivel buckles



SUPEROCCHIO

CLASSIC MASK



- EASY ADJUSTABLE BUCKLE
- TEMPERED GLASS



100% HIGH QUALITY
SOFT SILICONE **BLACK**



PRODUCT	PACK	CODE
SUPEROCCHIO BLACK	12	DN234650

ACTION

- MICROMETRIC ADJUSTABLE BUCKLE
- TEMPERED GLASS



100% HIGH QUALITY
SOFT SILICONE **CLEAR**

100% HIGH QUALITY
SOFT SILICONE **BLACK**



COLOURS	PACK	CODE
ACTION CLEAR	6	DS410060
ACTION BLACK	6	DS415050



MASKS OPTICAL LENSES



OPTICAL LENS FOCUS	CODE
1,0 DX/SX	DI240010
1,5 DX/SX	DI240015
2,0 DX/SX	DI240020
2,5 DX/SX	DI240025
3,0 DX/SX	DI240030
3,5 DX/SX	DI240035
4,0 DX/SX	DI240040
4,5 DX/SX	DI240045
5,0 DX/SX	DI240050
5,5 DX/SX	DI240055
6,0 DX/SX	DI240060
6,5 DX/SX	DI240065
7,0 DX/SX	DI240070
7,5 DX/SX	DI240075
8,0 DX/SX	DI240080

OPTICAL LENS BIG EYES EVO	CODE
1,0 DX	DI336010
1,5 DX	DI336015
2,0 DX	DI336020
2,5 DX	DI336025
3,0 DX	DI336030
3,5 DX	DI336035
4,0 DX	DI336040
4,5 DX	DI336045
5,0 DX	DI336050
5,5 DX	DI336055
6,0 DX	DI336060
1,0 SX	DI336110
1,5 SX	DI336115
2,0 SX	DI336120
2,5 SX	DI336125
3,0 SX	DI336130
3,5 SX	DI336135
4,0 SX	DI336140
4,5 SX	DI336145
5,0 SX	DI336150
5,5 SX	DI336155
6,0 SX	DI336160



MAIN MASKS SPARE PARTS

MASKS SPARE PARTS	CODE
MASK STRAP LOOP LARGE - CLEAR (PAIR)	DZ215007
MASK STRAP LOOP LARGE - BLACK (PAIR)	DZ215013
MASK STRAP LOOP SMALL - CLEAR (PAIR)	DZ215009
MASK STRAP LOOP SMALL - BLACK (PAIR)	DZ215011
SILICONE CLEAR STRAP FOR SEA LINE MASKS/FOCUS /BIG EYES	DZ215005
SILICONE BLACK STRAP FOR SEA LINE/FOCUS/BIG EYES	DZ215006
SILICONE CLEAR STRAP FOR PROFESSIONAL MASKS	DZ215003
SILICONE BLACK STRAP FOR PROFESSIONAL MASK	DZ215004
SILVER STRAP FOR CRYSTAL MASK	DZ215002
MASK STRAP CLEAR FOR F1	DZ210023
MASK STRAP BLACK FOR F1	DZ210025
BLACK BUCKLE BIG EYES (PAIR)	DZ210008
BLACK BUCKLES FOR FOCUS (PAIR)	DZ210010
BUCKLES PENTA/MATRIX/LINCE BUCKLES (PAIR)	DZ210018
BUCKLES FOR NANO/BIG EYES EVO OCCHIO PLUS/EYES EVO (PAIR)	DZ210021
BUCKLES FOR ONDA/PERLA/SIRENA/ONDINA JR PERLA JR/SIRENETTA JR/PIUMETTA	DZ210005
BUCKLES FOR MAREA/MAREA JR /SKY /SKY JR	DZ210020
BOX LARGE FOR MASKS	DZ250099
BOX MEDIUM FOR MASKS	DZ250098
BAG BLACK FOR COMBO SET	DZ250095
BAG WHITE/BLUE FOR JR. COMBO SET	DZ250090
BAG WHITE/PINK FOR JR. COMBO SET	DZ250091

FOR THE FULL LIST,
SEE OUR
SPARE PARTS
CATALOGUE



BOX FOR MASKS
LARGE OR MEDIUM

BAG BLACK
FOR COMBO SET



BAG
WHITE/BLUE - WHITE/PINK
FOR JR. COMBO SET



CRESSI

SNORKELING MASKS

BUYER'S GUIDE 2019



MAREA

ADULT SIZE

- ┆ 2 WINDOW
- ┆ TEMPERED GLASS
- ┆ MICROMETRIC ADJUSTABLE BUCKLE



COLOURS	PACK	CODE
MAREA YELLOW	6	DN282010
MAREA BLUE	6	DN282020
MAREA LILAC	6	DN282041
ASSORTED COLORAMA	12	DN282099



COLOURS	PACK	CODE
ASSORTED	12	DN281000
MAREA CLEAR/YELLOW	6	DN281010
MAREA CLEAR/BLUE	6	DN281020
MAREA CLEAR/PINK	6	DN281040
MAREA BLACK	6	DN285050



100% HIGH QUALITY
SOFT SILICONE **COLORAMA**



100% HIGH QUALITY
SOFT SILICONE



OCEAN

ADULT SIZE

- └ 2 WINDOW
- └ TEMPERED GLASS
- └ MICROMETRIC ADJUSTABLE BUCKLE



COLOURS	PACK	CODE
CLEAR/BLACK	6	DN291050
OCEAN CLEAR	6	DN291060
OCEAN AQUAMARINE	6	DN291063
ASSORTED	12	DN291099
BLACK	6	DN295050



100% HIGH QUALITY
SOFT SILICONE

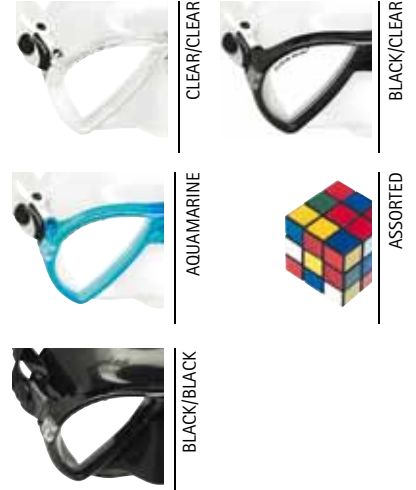

SKY

ADULT SIZE

- └ 1 WINDOW
- └ TEMPERED GLASS
- └ MICROMETRIC ADJUSTABLE BUCKLE



COLOURS	PACK	CODE
ASSORTED	12	DN200000



100% HIGH QUALITY
SOFT SILICONE CLEAR



ONDA

ADULT SIZE

- └ 1 WINDOW
- └ TEMPERED GLASS
- └ EASY ADJUSTABLE BUCKLE



COLOURS	PACK	CODE
ASSORTED	12	DN207000
ONDA CLEAR/YELLOW	6	DN207010
ONDA CLEAR/BLUE	6	DN207020
ONDA CLEAR/PINK	6	DN207040
ONDA BLACK/BLACK	6	DN207150



100% HIGH QUALITY
SOFT SILICONE



PERLA

ADULT SIZE

- └ 2 WINDOW
- └ TEMPERED GLASS
- └ EASY ADJUSTABLE BUCKLE



COLOURS	PACK	CODE
ASSORTED	12	DN208000
PERLA BLACK	6	DN208150
PERLA GREEN	6	DN208198



100% HIGH QUALITY
SOFT SILICONE



SIRENA

ADULT SIZE



- └ 1 WINDOW
- └ TEMPERED GLASS
- └ EASY ADJUSTABLE BUCKLE



COLOURS	PACK	CODE
ASSORTED	12	DN201000
SIRENA BLACK/CLEAR	6	DN202000
SIRENA DIVE CENTER EDITION	6	JDN200058



100% HIGH QUALITY
SOFT SILICONE



ASSORTED



BLACK/CLEAR



PINOCCHIO

ADULT SIZE



- └ 1 WINDOW
- └ TEMPERED GLASS
- └ VINTAGE RUBBER MASK



100% HIGH QUALITY
SOFT SILICONE **BLACK**

*"First mask
with a nose pocket
since 1952!"*

PRODUCT	PACK	CODE
PINOCCHIO BLACK	12	DN210000

MASK STRAP COVER

Soft neoprene strap cover mask with Cressi logo. It offers comfort and helps to hold the mask strap.



COLOURS	CODE
BLUE	DS339992
PINK	DS339994
BLACK	DS339995

ANTIFOG

SPRAY 60 ML

0% ALCOHOL

Effective anti-fog for masks and goggles. Spread on the inside of the lenses, before wetting them.



CODE
DF200050

ANTIFOG

GEL 30 ML



CODE
DF200052

DISPLAY

ANTIFOG LINE



ANTIFOG
NOT INCLUDED

CODE
VAESPOAF

MINIFOG

SPONGE



CODE
DF200053

ESTRELLA JUNIOR

AGE 7-13



- 1 WINDOW
- TEMPERED GLASS
- MICROMETRIC ADJUSTABLE BUCKLE

NEW

100% HIGH QUALITY
SOFT SILICONE CLEAR

CLEAR/BLUE



CLEAR/ORANGE



CLEAR/LIME



CLEAR/AQUAMARINE



CLEAR/PINK



ASSORTED

COLOURS	PACK	CODE
ESTRELLA JR CLEAR/BLUE	6	DN350020
ESTRELLA JR CLEAR/ORANGE	6	DN350085
ESTRELLA JR CLEAR/LIME	6	DN350067
ESTRELLA JR CLEAR/AQUAMARINE	6	DN350063
ESTRELLA JR CLEAR/PINK	6	DN350040
ESTRELLA JR ASSORTED	12	DN350099

MAREA JUNIOR

AGE 7-13



- 2 WINDOW
- TEMPERED GLASS
- MICROMETRIC ADJUSTABLE BUCKLE



COLOURS	PACK	CODE
MAREA JR YELLOW	6	DN284010
MAREA JR BLUE	6	DN284020
MAREA JR LILAC	6	DN284041
ASSORTED COLORAMA	12	DN284099

100% HIGH QUALITY
SOFT SILICONE **COLORAMA**



COLOURS	PACK	CODE
ASSORTED	12	DN283000
MAREA JR CLEAR/YELLOW	6	DN283010
MAREA JR CLEAR/BLUE	6	DN283020
MAREA JR CLEAR/PINK	6	DN283040

100% HIGH QUALITY
SOFT SILICONE **CLEAR**



ONDINA JUNIOR

AGE 7-13



- 1 WINDOW
- TEMPERED GLASS
- EASY ADJUSTABLE BUCKLE



100% HIGH QUALITY
SOFT SILICONE CLEAR

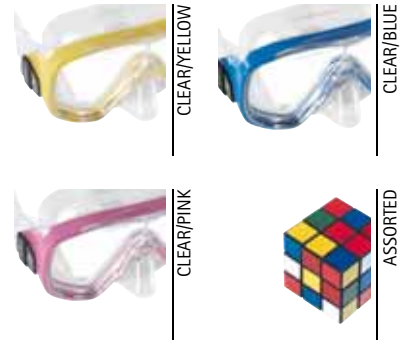

COLOURS	PACK	CODE
ASSORTED	12	DN206900
ONDINA JR CLEAR/YELLOW	6	DN206910
ONDINA JR CLEAR/BLUE	6	DN206920
ONDINA JR CLEAR/PINK	6	DN206940

PERLA JUNIOR

AGE 7-13



- 2 WINDOW
- TEMPERED GLASS
- EASY ADJUSTABLE BUCKLE



100% HIGH QUALITY
SOFT SILICONE CLEAR



COLOURS	PACK	CODE
ASSORTED	12	DN208300

SIRENETTA JUNIOR

AGE 7-13



- ┆ 1 WINDOW
- ┆ TEMPERED GLASS
- ┆ EASY ADJUSTABLE BUCKLE



100% HIGH QUALITY
SOFT SILICONE CLEAR



ASSORTED

COLOURS	PACK	CODE
ASSORTED	12	DN203000

MOON

AGE 7-15



- ┆ 2 WINDOW
- ┆ MICROMETRIC ADJUSTABLE BUCKLE



COLOURS	PACK	CODE
ASSORTED	12	DN200600
MOON KID CLEAR/LIME	6	DN200667
MOON KID CLEAR/LIGHT BLUE	6	DN200620
MOON KID COLORAMA LIGHT BLUE/LIME	6	DN200720
MOON KID COLORAMA PINK/LILAC	6	DN200740
MOON KID COLORAMA BLUE/ORANGE	6	DN200828

PIUMETTA KID

AGE 3-7

MADE IN
ITALY

ULTRA RESISTANT
POLYCARBONATE
LENSES



100% HIGH QUALITY
SOFT SILICONE CLEAR



CLEAR/YELLOW



CLEAR/BLUE



CLEAR/PINK



CLEAR/
AQUAMARINE



ASSORTED

COLOURS	PACK	CODE
YELLOW	12	DN200510
BLUE	12	DN200520
PINK	12	DN200540
AQUAMARINE	12	DN200563
ASSORTED	12	DN200500



CRESSI

C O M B O S

BUYER'S GUIDE 2019



CALIBRO + CORSICA

ADULT SIZE



COLOURS	PACK	CODE
BLACK	10	DS435050
GREEN	10	DS439850
WHITE	10	DS434030
BLUE NERY	10	DS434550

F1 + ALPHA ULTRA DRY

ADULT SIZE



COLOURS	PACK	CODE
BLACK	10	ZDN275000
WHITE	10	ZDN273000

BIG EYES EVOLUTION + ALPHA ULTRA DRY

ADULT SIZE



YELLOW



BLACK



BLUE



BLACK/BLACK



BLACK/BLUE



NEW



WIDTH
CM 24,5
HEIGHT
CM 51,5

COLOURS	PACK	CODE
YELLOW	10	DS337010
BLUE	10	DS337020
CLEAR/BLACK	10	DS337050
BLACK/BLACK	10	WDS337550
BLACK/BLUE	10	WDS337520

N

PENTA + ALPHA ULTRA DRY

ADULT SIZE



BLUE



BLACK



YELLOW



BLACK/BLACK



WIDTH
CM 24,5
HEIGHT
CM 51,5

COLOURS	PACK	CODE
BLUE	10	DS323020
YELLOW	10	DS323010
CLEAR/BLACK	10	DS323060
BLACK/BLACK	10	DS323550

MAREA DRY

ADULT SIZE



CLEAR/YELLOW



CLEAR/PINK



CLEAR/BLUE



BLACK/BLACK



WIDTH
CM 24,5
HEIGHT
CM 51,5

COLOURS	PACK	CODE
CLEAR/YELLOW	10	DM1000081
CLEAR/PINK	10	DM1000084
CLEAR/BLUE	10	DM1000082
BLACK/BLACK	10	DM1000085

MATRIX + GAMMA

ADULT SIZE



BLACK



BLUE



YELLOW



WIDTH
CM 24,5
HEIGHT
CM 51,5

COLOURS	PACK	CODE
BLUE	10	DS302501
YELLOW	10	DS302504
BLACK	10	DS302510

MAREA VIP

ADULT SIZE



100% HIGH QUALITY
SOFT SILICONE **COLORAMA**

100% HIGH QUALITY
SOFT SILICONE **CLEAR**



WIDTH
CM 24,5
HEIGHT
CM 51,5



COLOURS	PACK	CODE
YELLOW/ YELLOW	10	DM1000056
BLUE/BLUE	10	DM1000058
LILAC/LILAC	10	DM1000057
ASSORTED COLORAMA	10	DM1000059

COLOURS	PACK	CODE
ASSORTED	10	DM1000005
CLEAR/YELLOW	10	DM1000051
CLEAR/BLUE	10	DM1000052
CLEAR/PINK	10	DM1000054

OCEAN VIP

ADULT SIZE



SKY VIP

ADULT SIZE



CLEAR/BLACK



CLEAR/CLEAR



CLEAR/AQUAMARINE



CLEAR/BLUE



CLEAR/AQUAMARINE



CLEAR/YELLOW



BLACK/BLACK



NEW

ASSORTED



WIDTH
CM 24,5
HEIGHT
CM 51,5

ASSORTED



WIDTH CM 45 - HEIGHT CM 15



COLOURS	PACK	CODE
CLEAR/AQUAMARINE	10	DM1000113
CLEAR/BLACK	10	DM1000115
CLEAR/CLEAR	10	DM1000116
BLACK/BLACK	10	WDM1000125
ASSORTED	10	DM100011

COLOURS	PACK	CODE
CLEAR/YELLOW	10	DM1000001
CLEAR/BLUE	10	DM1000002
CLEAR/AQUAMARINE	10	DM1000003
ASSORTED	10	DM100000

ONDA MARE

ADULT SIZE



CLEAR/YELLOW



CLEAR/PINK



CLEAR/BLUE



CLEAR/AQUAMARINE

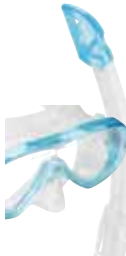

ASSORTED



BLACK/BLACK



WIDTH CM 45 - HEIGHT CM 15



COLOURS	PACK	CODE
ASSORTED	10	DM101015
CLEAR/YELLOW	10	DM1010151
CLEAR/BLUE	10	DM1010152
CLEAR/PINK	10	DM1010154
CLEAR/AQUAMARINE	10	DM1010153
BLACK/BLACK	10	DM1010155

PERLA MARE

ADULT SIZE



ASSORTED



BLACK



WIDTH CM 45 - HEIGHT CM 15



COLOURS	PACK	CODE
ASSORTED	10	DM101017
BLACK	10	DM102017

ESTRELLA JR VIP

JUNIOR SIZE AGE 7-13

NEW

MADE IN ITALY

NEW

PEGASO +IGUANA DRY

JUNIOR SIZE AGE 7-13



CLEAR/BLUE



CLEAR/LIME



CLEAR/PINK



CLEAR/AQUAMARINE



CLEAR/ORANGE



ASSORTED



WIDTH
CM 24,5
HEIGHT
CM 51,5

BLUE/WHITE



LILAC/WHITE



CLAMSHELL

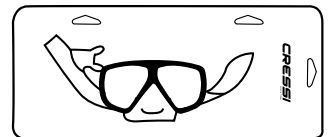

COLOURS	PACK	CODE
ASSORTED	10	DM350000
CLEAR/BLUE	10	DM350020
CLEAR/LIME	10	DM350067
CLEAR/PINK	10	DM350040
CLEAR/AQUAMARINE	10	DM350063
CLEAR/ORANGE	10	DM350085

COLOURS	PACK	CODE
BLUE/WHITE	10	DM272030
LILAC/WHITE	10	DM274130

MAREA VIP JR

JUNIOR SIZE AGE 7-13



100% HIGH QUALITY
SOFT SILICONE **COLORAMA**

100% HIGH QUALITY
SOFT SILICONE **CLEAR**

YELLOW



BLUE



CLEAR/YELLOW



CLEAR/PINK



LILAC



ASSORTED



COLORAMA

WIDTH CM 45 - HEIGHT CM 15



CLEAR/BLUE



ASSORTED



COLOURS	PACK	CODE
ASSORTED COLORAMA	10	DM1000069
YELLOW/YELLOW	10	DM1000066
BLUE/BLUE	10	DM1000068
LILAC/LILAC	10	DM1000067

COLOURS	PACK	CODE
ASSORTED	10	DM100006
CLEAR/YELLOW	10	DM1000061
CLEAR/PINK	10	DM1000064
CLEAR/BLUE	10	DM1000062

SKY VIP JR

JUNIOR SIZE AGE 7-13



CLEAR/AQUAMARINE



CLEAR/PINK



CLEAR/BLUE



ASSORTED



WIDTH
cm 45
HEIGHT
cm 15

COLOURS	PACK	CODE
ASSORTED	10	DM100200
CLEAR/BLUE	10	DM1002002
CLEAR/AQUAMARINE	10	DM1002003
CLEAR/ PINK	10	DM1002004

ONDINA VIP JR

JUNIOR SIZE AGE 7-13



CLEAR/YELLOW



CLEAR/PINK



CLEAR/BLUE



CLEAR/AQUAMARINE



ASSORTED



WIDTH
cm 45
HEIGHT
cm 15

COLOURS	PACK	CODE
ASSORTED	10	DM101013
CLEAR/YELLOW	10	DM1010131
CLEAR/BLUE	10	DM1010132
CLEAR/PINK	10	DM1010134
CLEAR/AQUAMARINE	10	DM1010133

PERLA MARE JR

JUNIOR SIZE AGE 7-13



ASSORTED



WIDTH
cm 45
HEIGHT
cm 15

COLOURS	PACK	CODE
ASSORTED	10	DM101018

MOON +TOP COLORAMA

JUNIOR SIZE AGE 7-13



LIGHT BLUE/LIME



COLORAMA

PINK/LILAC



COLORAMA

CLEAR/LIGHT BLUE



CLEAR/LIME



ASSORTED



WIDTH
cm 45
HEIGHT
cm 15

COLOURS	PACK	CODE
ASSORTED	10	DM200600
CLEAR/LIGHT BLUE	10	DM200620
CLEAR/LIME	10	DM200667
COLORAMA LIGHT BLUE/LIME	10	DM200720
COLORAMA PINK/LILAC	10	DM200740

CRESSI

S N O R K E L S

BUYER'S GUIDE 2019



OMEGA ULTRA DRY

ADULT SIZE

- DRY GUARD
- PURGE VALVE



NEW

100% HIGH QUALITY SOFT SILICONE

High-tech snorkel with a special patented "Aquistop" valve at the top that keeps water out, making breathing easier and more natural. The tube has an expanded elliptical shape in order to increase comfort and air-delivery capacity. Silicone mouthpiece with a new anatomical shape. Purge valve in a better position to improve an easier water draining.



QUICK RELEASE SNORKEL HOLDER



360° ANGLE DRY PROTECTION TECHNOLOGY



Guillemberg
-126m



COLOURS	PACK	CODE
OMEGA ULTRA DRY BLACK	6	ES275050
OMEGA ULTRA DRY BLACK/BLUE NERY	6	ES275550
OMEGA ULTRA DRY BLACK/GOLD	6	ES275009

ALPHA ULTRA DRY

ADULT SIZE



- DRY GUARD
- PURGE VALVE



100% HIGH QUALITY SOFT SILICONE

DRY MOUTHPIECE WITH STRAIGHT HOSE

Special snorkel with a special patented "Aquistop" valve at the top that keeps water out, making breathing easier and more natural. The tube has an expanded elliptical shape in order to increase comfort and air-delivery capacity. Purge valve and corrugated section near the mouthpiece.

QUICK RELEASE SNORKEL HOLDER



360° ANGLE DRY PROTECTION TECHNOLOGY



ULTRA FLEXIBLE TUBE

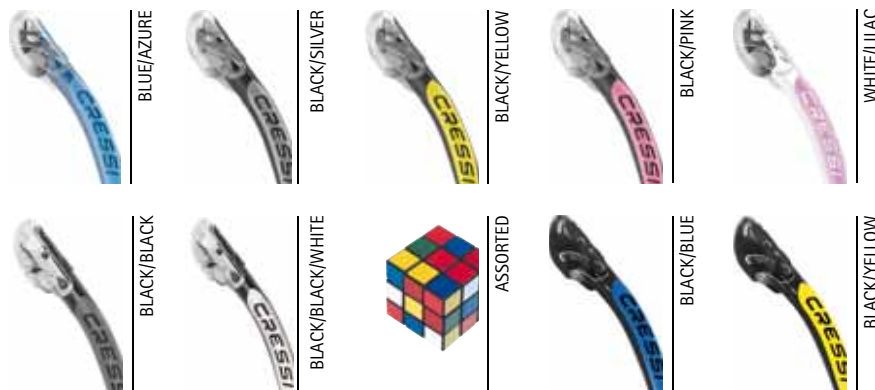

COLOURS	PACK	CODE
ALPHA ULTRA DRY BLUE/AZURE	6	ES258020
ALPHA ULTRA DRY BLACK/SILVER	6	ES258055
ALPHA ULTRA DRY BLACK/YELLOW	6	ES258051
ALPHA ULTRA DRY BLACK/PINK	6	ES258054
ALPHA ULTRA DRY WHITE/LILAC	6	ES258041
ALPHA ULTRA DRY ASSORTED	12	ES258099
ALPHA ULTRA DRY BLACK	6	ES258150
ALPHA ULTRA DRY BLACK/BLACK/WHITE	6	ES258130
ALPHA ULTRA DRY BLACK/BLUE	6	ES258062
ALPHA ULTRA DRY BLACK/YELLOW	6	ES258151

DRY

ADULT SIZE

- DRY GUARD
- PURGE VALVE



100% HIGH QUALITY SOFT SILICONE

The dry-top design allows users to take every breath with confidence and focus on the reef below. A float-activated valve instantly seals off the breathing tube if submerged while swimming or from overhead waves. A generous bore provides ample airflow and a lower purge valve enables instant clearing when needed.

TECHNICAL FEATURES

- Dry-top valve seals breathing tube when submerged
- Flexible lower bore reduces jaw fatigue
- Mouthpiece drops away when not in use great for scuba divers
- High-quality silicone mouthpiece is comfortable and durable
- Angled mouthpiece reduces jaw fatigue
- Lower purge valve allows water to be quickly expelled
- Streamlined design reduces drag while swimming
- Adjustable clip for securing to any mask



COLOURS	PACK	CODE
DRY CLEAR/YELLOW	6	ES259010
DRY CLEAR/PINK	6	ES259040
DRY CLEAR/SILVER	6	ES259060
DRY CLEAR/AZURE	6	ES259062
DRY CLEAR/LILAC	6	ES259080
DRY BLACK	6	ES259550

BETA

ADULT SIZE



- SPLASH GUARD
- PURGE VALVE



100% HIGH QUALITY SOFT SILICONE

The Beta (semi dry) allows users to take every breath with confidence and focus on the reef below. A generous bore provides ample airflow and a lower purge valve enables instant clearing when needed.

TECHNICAL FEATURES

- Profiled splash guard significantly reduces water entry
- Flexible lower bore reduces jaw fatigue
- Mouthpiece drops away when not in use-great for scuba divers
- High-quality silicone mouthpiece is comfortable and durable
- Angled mouthpiece reduces jaw fatigue
- Lower purge valve allows water to be quickly expelled
- Streamlined design reduces drag while swimming
- Adjustable clip for securing to any mask
- Streamlined shape reduces drag while swimming

ULTRA FLEXIBLE TUBE



COLOURS	PACK	CODE
BETA SILVER/AZURE	6	ES257020
BETA SILVER/BLACK	6	ES257055
BETA SILVER/YELLOW	6	ES257051
BETA SILVER/PINK	6	ES257054
BETA WHITE/LILAC	6	ES257041
BETA BLACK	6	ES257150
ASSORTED	12	ES257099

TAO

ADULT SIZE

- SPLASH GUARD
- PURGE VALVE



PRICE REDUCTION!

100% HIGH QUALITY SOFT SILICONE **CLEAR**

100% HIGH QUALITY SOFT SILICONE **BLACK**

Upper splash guard and water drain valve make this aerator extremely versatile and comfortable.

QUICK RELEASE SNORKEL HOLDER



SPLASH GUARD



PURGE VALVE



COLOURS	PACK	CODE
TAO CLEAR/YELLOW	6	ES260010
TAO CLEAR/BLUE	6	ES260020
TAO CLEAR/PINK	6	ES260040
TAO CLEAR/BLACK	6	ES260050
TAO BLACK/BLACK	6	ES260550

GAMMA

ADULT SIZE



- SPLASH GUARD
- PURGE VALVE



100% HIGH QUALITY
SOFT SILICONE **CLEAR**

100% HIGH QUALITY
SOFT SILICONE **BLACK**

Streamlined and compact, the Gamma is easy to pack for warm water vacations and an excellent choice for divers and snorkelers who appreciate the confidence and cleanliness of using their own equipment. An upper splash guard drastically reduces water entry from waves, and a clever drainage well collects water that does enter so it can be quickly expelled without interfering with breathing.

TECHNICAL FEATURES

- Profiled splash guard significantly reduces water entry
- Flexible lower bore reduces jaw fatigue
- Compact shape excellent for packing
- Adjustable clip for securing to any mask
- High-quality silicone mouthpiece is comfortable and durable
- Angled mouthpiece reduces jaw fatigue
- Lower purge valve allows water to be quickly expelled
- Streamlined shape reduces drag while swimming



COLOURS	PACK	CODE
GAMMA CLEAR/YELLOW	6	EG261010
GAMMA CLEAR/BLUE	6	EG261020
GAMMA CLEAR/PINK	6	EG261040
GAMMA CLEAR	6	EG261060
GAMMA CLEAR/AQUAMARINE	6	EG261063
GAMMA CLEAR/LILAC	6	EG261041
ASSORTED	12	EG261000
GAMMA BLACK	6	EG261550

MEXICO

ADULT SIZE



SPLASH GUARD



100% HIGH QUALITY
SOFT SILICONE **CLEAR**

100% HIGH QUALITY
SOFT SILICONE **BLACK**

A classic snorkel for minimalists, the Mexico includes a splash guard up top, adjustable snorkel keeper and soft, silicone mouthpiece. Its efficient design allows for easy clearing and very little drag while swimming.

TECHNICAL FEATURES

- Splash guard reduces water entry
- Classic, pre-shaped bore positions mouthpiece properly
- Adjustable clip for securing to any mask
- High-quality silicone mouthpiece is comfortable and durable
- Angled mouthpiece reduces jaw fatigue
- Streamlined design reduces drag while swimming



COLOURS	PACK	CODE
MEXICO CLEAR/YELLOW	6	EG269010
MEXICO CLEAR/BLUE	6	EG269020
MEXICO CLEAR	6	EG269060
MEXICO CLEAR/AQUAMARINE	6	EG269063
MEXICO CLEAR/PINK	6	EG269040
MEXICO BLACK	6	EG269550
ASSORTED	12	EG269000

CORSICA

ADULT SIZE



ULTRA FLEX MATERIAL



ULTRA FLEXIBLE TUBE

100% HIGH QUALITY SILICONE

100% HIGH QUALITY SOFT SILICONE

CORSICA is a new highly technical snorkel designed specifically for deep freediving and spearfishing. The soft bendable large diameter tubing makes it extremely comfortable to properly position behind the head while maintaining ease of breathing on the surface. When diving, the mouthpiece tucks neatly under the chin for the ultimate in hydrodynamics. The anatomical hypoallergenic silicone mouthpiece provides extreme comfort during long durations in the water. The CORSICA is available in either black or green and is an excellent choice for the discriminating diver who is looking for the best equipment.



COLOURS	PACK	CODE
CORSICA BLACK	12	EG268550
CORSICA BLACK/GREEN	12	EG268598
CORSICA BLU NERY	12	EG268555
CORSICA WHITE	12	EG268530

AMERICA

BLACK

ADULT SIZE



100% HIGH QUALITY SOFT SILICONE **BLACK**

AMERICA is a snorkel specifically designed for deep freediving and spearfishing. This snorkel provides excellent surface breathing properties due to its shorter, large bore flexible tubing with minimal curves to maintain a proper position around the head. The multi-positional soft silicone swivel mouthpiece can be tuned at any angle to provide extreme comfort during long durations in the water.

TECHNICAL FEATURES

- The multi-positional silicone soft mouthpiece provides extreme comfort during prolonged use
- Large diameter Snorkel Tube provides unobstructed ease of breathing
- Minimal tube and mouthpiece bends provides easier clearing capability

PRODUCT	PACK	CODE
AMERICA BLACK	12	EG267050

GRINGO BLACK

ADULT SIZE



GRINGO is a traditional snorkel used for all types of diving. This snorkel provides excellent surface breathing properties due to its fairly straight tubing with minimal curves to maintain a proper position around the head. The multi-positional soft silicone swivel mouthpiece can be tuned at any angle to provide extreme comfort during long durations in the water.

TECHNICAL FEATURES

- The multi-positional silicone soft mouthpiece provides extreme comfort during prolonged use
- Large diameter Snorkel Tube provides unobstructed ease of breathing
- Minimal tube and mouthpiece bends provides easier clearing capability

PRODUCT	PACK	CODE
GRINGO BLACK	12	EG266000

ISLAND

ADULT SIZE

NEW

CRESSI
dive center



FIXED KEEPER
THAT AVOID
LOSS DURING
SNORKELING

PRODUCT	PACK	CODE
ISLAND	12	JUS260058

MINIDRY

SMALL SIZE

- DRY GUARD
- PURGE VALVE

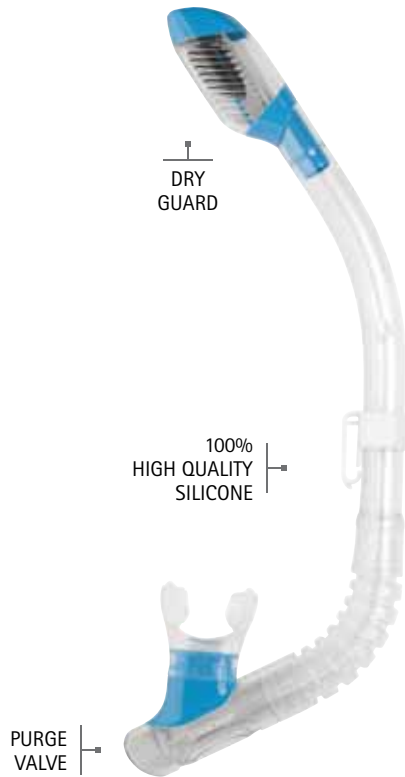

100% HIGH QUALITY SOFT SILICONE **CLEAR**

Version of the Dry model for women and children. The MiniDry snorkel has an original anti-splash end with a special valve that seals the tube as you dive, almost totally preventing the entrance of water as the snorkel is submerged. The lower end has a corrugated part that is smooth on the inside and keeps the snorkel away from the mouth when using breathing apparatus. A special water collection cup, with a large elliptic discharge valve makes expelling water quick and easy.

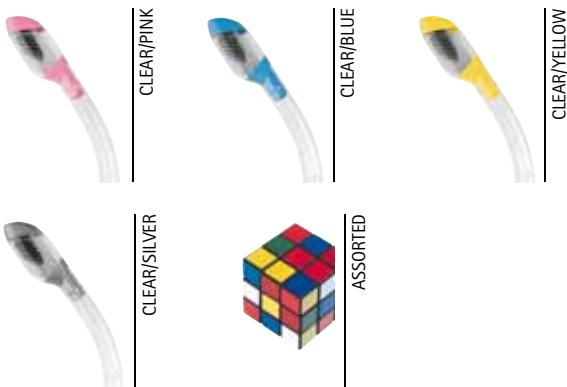

COLOURS	PACK	CODE
MINIDRY CLEAR/PINK	12	ES258840
MINIDRY CLEAR/YELLOW	12	ES258810
MINIDRY CLEAR/BLUE	12	ES258820
MINIDRY CLEAR/SILVER	12	ES258960
ASSORTED	12	ES258899

TOP

SMALL SIZE



- SPLASH GUARD
- PURGE VALVE

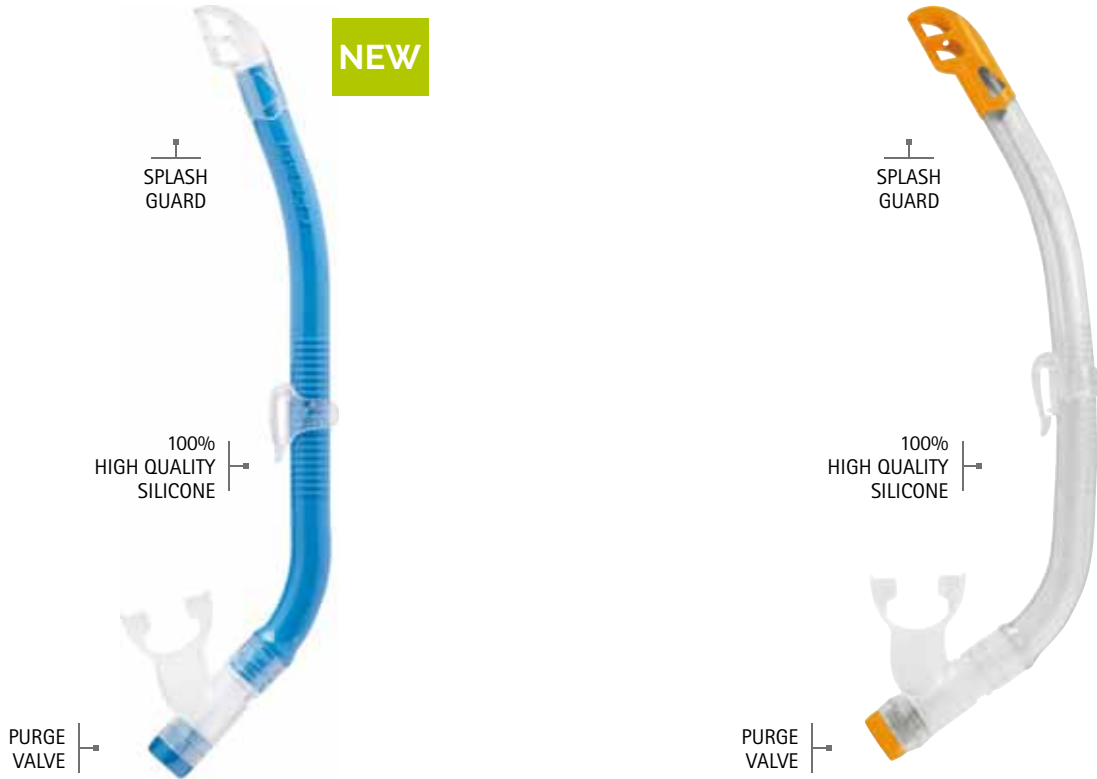

Sized for optimal comfort and performance for kids, the Top uses the same quality materials as adult snorkels. A splash guard helps reduce water entry and a purge valve below the mouthpiece makes for effortless clearing. The fully adjustable snorkel keeper allows for perfect positioning.

TECHNICAL FEATURES

- Smaller size for young explorers
- Splash guard helps minimize water entry from splashing or waves
- High-quality silicone mouthpiece is comfortable and durable
- Angled mouthpiece reduces jaw fatigue
- Lower purge valve allows water to be quickly expelled
- Adjustable clip for securing to any mask

100% HIGH QUALITY
SOFT SILICONE **COLORAMA**

100% HIGH QUALITY
SOFT SILICONE **CLEAR**

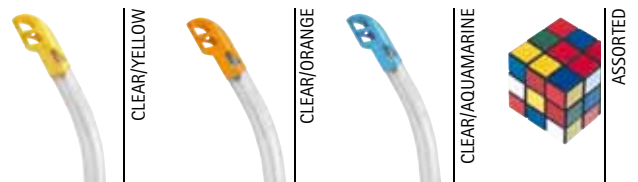

COLOURS	PACK	CODE
TOP COLORAMA BLUE	6	ES269120
TOP COLORAMA GREEN	6	ES269167
TOP COLORAMA PINK	6	ES269140

COLOURS	PACK	CODE
TOP CLEAR/YELLOW	6	ES269010
TOP CLEAR/ORANGE	6	ES269085
TOP CLEAR/AQUAMARINE	6	ES269063
ASSORTED	12	ES269099

MINIGRINGO

KID SIZE



Traditional snorkel for snorkelling and free diving.
Flexible, standard bore tube, complete with sliding elastic clip to attach it to your mask.

PRODUCT	PACK	CODE
MINIGRINGO	12	EG265500

MAIN SNORKELS SPARE PARTS

SNORKELS SPARE PARTS	CODE
SNORKEL KEEPER BLACK (CALIFORNIA/GRINGO)	EZ260003
SNORKEL KEEPER BLACK (AMERICA)	EZ267004
SNORKEL KEEPER (MEXICO/CORSICA)	EZ267005
SNORKEL KEEPER CLEAR (GAMMA)	EZ267009
SNORKEL KEEPER (TOP)	EZ267011
SNORKEL KEEPER (ALPHA ULTRA DRY - BETA)	EZ267015
SNORKEL KEEPER (KAPPA ULTRA DRY - SIGMA)	EZ267013
SNORKEL KEEPER (DRY - TAO - OMEGA)	EZ267018
SNORKEL KEEPER (MINI DRY)	EZ267019

FOR THE FULL LIST,
SEE OUR
SPARE PARTS
CATALOGUE



CRESSI

Cressi
swim

S W I M L I N E

BUYER'S GUIDE 2019



SKYLIGHT

ADULT SIZE | 180 DEGREES WIDE VIEW SWIM GOGGLES

MADE IN
ITALY

- U.S. PAT 5.956.778
- TOTAL VISION
- MICROMETRIC ADJUSTABLE BUCKLE
- 100% ANTI UV LENS
- ANTI SCRATCH LENS
- ANTI FOG LENS
- 2 YEAR WARRANTY



COLOURS	PACK	CODE
SKYLIGHT CLEAR/BLACK BLUE	6	DE203320
SKYLIGHT CLEAR/WHITE PINK	6	DE203340
SKYLIGHT CLEAR/BLACK LIME	6	DE203367
SKYLIGHT CLEAR/WHITE BLUE	6	DE203322
SKYLIGHT CLEAR/WHITE BLACK	6	DE203350
ASSORTED	12	DE203399
SKYLIGHT BLUE NERY	6	DE203355
SKYLIGHT BLACK SMOKED LENSES	6	DE203450
SKYLIGHT BLACK/BLACK LIME	6	DE203467
SKYLIGHT BLACK/WHITE BLACK	6	DE203451
SKYLIGHT 12 PIECES		DE203301

100% HIGH QUALITY
SILICONE **CLEAR**

100% HIGH QUALITY
SILICONE **BLACK**

70 years of mask designs and today's advanced technology comes together in this Cressi master-piece.

We are proud to introduce the best open ocean google in the market. It is not only for the serious swimmer.

The Skylight has the very best fit for hours and with wide vision to keep track of the directions which is actually what every swimmer would like to get out of a google. If your customers needs the very best google in the market, this is what you should get them.

COMFORTABLE LEAK PROOF SKIRT
FOR A UNIVERSAL FIT

PERFECT FOR OPEN WATER
AND RECREATIONAL SWIMMING

SIZE A

5 INCH - 124 MM

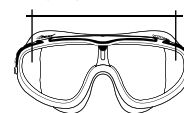

REUSABLE PROTECTIVE BOX
cm 13.5x21



SKYLIGHT MIRRORED LENSES

ADULT SIZE | 180 DEGREES WIDE VIEW SWIM GOGGLES

MADE IN ITALY

- U.S. PAT 5.956.778
- TOTAL VISION
- MICROMETRIC ADJUSTABLE BUCKLE
- 100% ANTI UV LENS
- ANTI SCRATCH LENS
- ANTI FOG LENS
- 2 YEAR WARRANTY



100% HIGH QUALITY
SILICONE **CLEAR**

100% HIGH QUALITY
SILICONE **BLACK**

COMFORTABLE LEAK PROOF SKIRT
FOR A UNIVERSAL FIT

PERFECT FOR OPEN WATER
AND RECREATIONAL SWIMMING

SIZE A

5 INCH - 124 MM



REUSABLE PROTECTIVE BOX
cm 13.5x21



MIRRORED
LENSES

MIRRORED
LENSES



CLEAR/BLACK



BLACK/BLACK

COLOURS	PACK	CODE
SKYLIGHT CLEAR/BLACK MIRRORED LENSES	6	DE2033750
SKYLIGHT BLACK/BLACK MIRRORED LENSES	6	DE2034750



PLANET

ADULT SIZE

- U.S. PAT 5.956.778
- TOTAL VISION
- MICROMETRIC ADJUSTABLE BUCKLE
- 100% ANTI UV LENS
- ANTI SCRATCH LENS
- ANTI FOG LENS
- 2 YEAR WARRANTY



CLEAR/BLUE/BLACK



CLEAR/BLUE/WHITE



CLEAR/BLACK/SILVER



CLEAR/WHITE/PINK



CLEAR/WHITE/LILAC



BLACK/LIME



BLACK/BLUE

SMOKED LENSES



CLEAR/BLACK/SILVER



BLUE NERY

*Customer's
-126m*



ASSORTED



BLACK/RED

COLOURS	PACK	CODE
PLANET CLEAR/BLUE/WHITE	6	DE202620
PLANET CLEAR/BLACK/SILVER	6	DE202650
PLANET CLEAR/BLACK/SILVER/SMOKED LENSES	6	DE202651
PLANET LADY CLEAR/WHITE/PINK	6	DE202640
PLANET LADY CLEAR/WHITE/LILAC	6	DE202641
PLANET CLEAR/BLUE/BLACK	6	DE202722
PLANET BLACK/LIME	6	DE202767
PLANET BLACK/BLUE	6	DE202723
ASSORTED	12	DE202699
PLANET BLACK/RED/SMOKED LENSES	6	DE202758
PLANET BLUE NERY	6	DE2026555

MADE IN ITALY

100% HIGH QUALITY SILICONE CLEAR

100% HIGH QUALITY SILICONE BLACK

Goggles with facial soft silicone which ensures perfect adaptability to a wide range of facial profiles Ideal for swimming, triathlon and water sports for all Good face seal and great comfort, shatterproof lenses with UV protection and scratch-resistant external treatment internal anti-fog treatment and extra strong Interchangeable strap instantly with patented buckles with micrometric adjustment and immediate, similar to those of the Cressi-sub diving masks Wide range of colors Special packaging to preserve its characteristics over time

COMFORTABLE LEAK PROOF SKIRT FOR A UNIVERSAL FIT

PERFECT FOR OPEN WATER AND RECREATIONAL SWIMMING

SIZE B

5.14 INCH - 131 MM

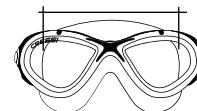

REUSABLE PROTECTIVE BOX cm 13.5x21



COBRA

ADULT SIZE

MADE IN
ITALY

- U.S. PAT 5.956.778
- TOTAL VISION
- MICROMETRIC ADJUSTABLE BUCKLE
- ULTRA CLEAR SKIRT
- 100% ANTI UV LENS
- ANTI SCRATCH LENS
- ANTI FOG LENS
- 2 YEAR WARRANTY



COLOURS	PACK	CODE
COBRA CLEAR/BLUE	6	DE201922
COBRA CLEAR/WHITE/SMOKED LENSES	6	DE201931
COBRA CLEAR/BLACK	6	DE201950
COBRA CLEAR/RED	6	DE201958
COBRA CLEAR/PINK	6	DE201940
ASSORTED	12	DE201999
COBRA BLACK/SMOKED LENSES	6	DE201992
COBRA BLACK/RED	6	DE201991

100% HIGH QUALITY
SILICONE **CLEAR**

100% HIGH QUALITY
SILICONE **BLACK**

Goggles with a single-piece skirt that is characterised by the presence of an elastic element within the structure that allows a perfect fit on most facial profiles. Shatterproof lenses with anti-scratch treatment, UV protection and internal anti-fog treatment. Indestructible, micrometrically adjustable buckles. Possibility of instantly replacing the buckle-strap structure with other models from the Cressi range. Special packaging maintains these characteristics over time.

COMFORTABLE LEAK PROOF SKIRT
FOR A UNIVERSAL FIT

PERFECT FOR OPEN WATER
AND RECREATIONAL SWIMMING

SIZE A

4.75 INCH - 123 MM



REUSABLE PROTECTIVE BOX
cm 13.5x21



GALILEO

ADULT SIZE | THE ONLY GOGGLE IN THE CRESSI SWIM LINE WITH TEMPERED GLASS LENSES

MADE IN
ITALY

- U.S. PAT 5.956.778
- MICROMETRIC ADJUSTABLE BUCKLE
- 100% ANTI UV LENS
- ANTI SCRATCH LENS
- ANTI FOG LENS
- 2 YEAR WARRANTY



100% HIGH QUALITY SILICONE CLEAR

The Galileo goggles have marked a historical turning point in the swimming goggles sector.

In actual fact, their flat lenses are mounted on a rigid frame, just like a diving mask, thus guaranteeing perfect vision with no distortion.

The shape of the lenses, which are perfectly flat and have no side curving, also prevents annoying distortion at the sides of the lenses.

The watertight seal is extraordinary and comfort is excellent. The strap has a quick adjustment system (Cressi patented).

similar to that used on the prestigious Cressi-sub masks, which allows quick and easy adjustment.

The shatterproof lenses have external anti-scratch treatment, UV protection and internal anti-fog treatment.

REUSABLE PROTECTIVE BOX
cm 13.5x21



COLOURS	PACK	CODE
GALILEO AQUAMARINE	6	DE205599
N GALILEO BLACK	6	DE205050
N GALILEO BLUE NERY	6	DE205055
N GALILEO WHITE	6	DE205030



THUNDER

ADULT SIZE | ADVANCED SWIMMER

MADE IN
ITALY

- U.S. PAT 5.956.778
- TOTAL VISION
- MICROMETRIC ADJUSTABLE BUCKLE
- ULTRA CLEAR SKIRT
- INCLINED 18° LENSES
- 100% ANTI UV LENS
- ANTI SCRATCH LENS
- ANTI FOG LENS
- 2 YEAR WARRANTY

SILICONE
STRAP



EASY
ADJUSTABLE
BUCKLES
U.S. PAT 5.956.778
Device for regulating
the length of a swimming
goggles strap

FLEXIBLE
NOSE BRIDGE
FITS VARIOUS
FACIAL PROFILES



COLOURS	PACK	CODE
THUNDER BLACK/WHITE/BLUE	6	DE203520
THUNDER BLACK/WHITE/ORANGE	6	DE203585
THUNDER BLACK/WHITE/LIME	6	DE203567
THUNDER BLACK/SILVER/BLACK	6	DE203650
THUNDER BLACK/SILVER/BLACK MIRRORED LENSES	6	DE2036750
ASSORTED	12	DE203599

100% HIGH QUALITY
ULTRA CLEAR TPR **CLEAR**

100% HIGH QUALITY
TPR **BLACK**

COMFORTABLE LEAK PROOF SKIRT
FOR A UNIVERSAL FIT

PERFECT FOR OPEN WATER
AND RECREATIONAL SWIMMING

FLEXIBLE NOSE BRIDGE
FITS VARIOUS FACIAL PROFILES

REUSABLE PROTECTIVE BOX
cm 13.5x21



FLASH

ADVANCED SWIMMER | ADULT SIZE - CRESSI'S PREMIUM SWIM GOGGLES



- U.S. PAT 5.956.778
- TOTAL VISION
- MICROMETRIC ADJUSTABLE BUCKLE
- ULTRA CLEAR SKIRT
- INCLINED 18° LENSES
- 100% ANTI UV LENS
- ANTI SCRATCH LENS
- ANTI FOG LENS
- 2 YEAR WARRANTY



COLOURS	PACK	CODE
FLASH CLEAR/BLUE	6	DE202322
FLASH CLEAR/AZURE/AZURE LENSES	6	DE202323
FLASH CLEAR/WHITE/SMOKED LENSES	6	DE202331
FLASH CLEAR/RED	6	DE202358
FLASH CLEAR/BLACK	6	DE202350
ASSORTED	12	DE202399
FLASH BLUE/WHITE	6	DE202320
FLASH BLACK/SMOKED LENSES	6	DE202392
FLASH BLACK/RED	6	DE202391

100% HIGH QUALITY
ULTRA CLEAR TPR **CLEAR**

100% HIGH QUALITY
TPR **BLACK**

Flash goggles are characterized by the presence of an elastic element within the structure which allows for perfect adaptability to a large number of facial profiles. Lenses are slightly curved on the outer profile, offering maximum visibility. Shatterproof lenses with scratchproof treatment and UV protection, as well as internal anti-fogging treatment. Indestructible, micrometrically adjustable buckles. Possibility of instantly replacing the buckle-strap structure with other models from the Cressi range.

COMFORTABLE LEAK PROOF SKIRT
FOR A UNIVERSAL FIT

PERFECT FOR OPEN WATER
AND RECREATIONAL SWIMMING

FLEXIBLE NOSE BRIDGE
FITS VARIOUS FACIAL PROFILES

SIZE D

5.50 INCH - 140 MM



REUSABLE PROTECTIVE BOX
cm 13.5x21



FLASH MIRRORED LENSES

ADVANCED SWIMMER | ADULT SIZE - CRESSI'S PREMIUM SWIM GOGGLES



- U.S. PAT 5.956.778
- TOTAL VISION
- MICROMETRIC ADJUSTABLE BUCKLE
- ULTRA CLEAR SKIRT
- INCLINED 18° LENSES
- 100% ANTI UV LENS
- ANTI SCRATCH LENS
- ANTI FOG LENS
- 2 YEAR WARRANTY



**MIRRORED
LENSES**



CLEAR/GREEN

**MIRRORED
LENSES**



CLEAR/BLUE

COLOURS	PACK	CODE
FLASH CLEAR GREEN MIRRORED LENSES	6	DE2023757
FLASH CLEAR BLUE MIRRORED LENSES	6	DE2023752

100% HIGH QUALITY
ULTRA CLEAR TPR **CLEAR**

100% HIGH QUALITY
TPR **BLACK**

COMFORTABLE LEAK PROOF SKIRT
FOR A UNIVERSAL FIT

PERFECT FOR OPEN WATER
AND RECREATIONAL SWIMMING

FLEXIBLE NOSE BRIDGE
FITS VARIOUS FACIAL PROFILES

SIZE D

5.50 INCH - 140 MM



REUSABLE PROTECTIVE BOX
cm 13.5x21



FLASH LADY

ADVANCED SWIMMER | ADULT SIZE - CRESSI'S PREMIUM SWIM GOGGLES

MADE IN
ITALY

- U.S. PAT 5.956.778
- TOTAL VISION
- MICROMETRIC ADJUSTABLE BUCKLE
- ULTRA CLEAR SKIRT
- INCLINED 18° LENSES
- 100% ANTI UV LENS
- ANTI SCRATCH LENS
- ANTI FOG LENS
- 2 YEAR WARRANTY



COLOURS	PACK	CODE
FLASH LADY CLEAR/BLUE	6	DE203020
FLASH LADY CLEAR/BLACK	6	DE203050
FLASH LADY CLEAR/WHITE/SMOKED LENSES	6	DE203031
FLASH LADY CLEAR/LILAC	6	DE203041
FLASH LADY CLEAR/PINK	6	DE203040
ASSORTED	12	DE203099
FLASH LADY BLACK/SMOKED LENSES	6	DE202950

100% HIGH QUALITY
ULTRA CLEAR TPR **CLEAR**

100% HIGH QUALITY
TPR **BLACK**

COMFORTABLE LEAK PROOF SKIRT
FOR A UNIVERSAL FIT

PERFECT FOR OPEN WATER
AND RECREATIONAL SWIMMING

FLEXIBLE NOSE BRIDGE
FITS VARIOUS FACIAL PROFILES

SIZE B

5 INCH - 127 MM



REUSABLE PROTECTIVE BOX
cm 13.5x21



RIGHT

ADULT SIZE

- U.S. PAT 5.956.778
- MICROMETRIC ADJUSTABLE BUCKLE
- 100% ANTI UV LENS
- ANTI SCRATCH LENS
- ANTI FOG LENS
- 2 YEAR WARRANTY



BLUE



CLEAR



BLUE NERY

AZURE
LENSES



CLEAR

Cambridge
-126m



ASSORTED



BLACK



WHITE

COLOURS	PACK	CODE
RIGHT BLUE	6	DE201621
RIGHT CLEAR	6	DE201660
RIGHT BLUE NERY	6	DE2016555
RIGHT CLEAR/AZURE LENSES	6	DE201663
ASSORTED	12	DE201699
RIGHT BLACK	6	DE201650
RIGHT WHITE	6	DE201635

MADE IN
ITALY

100% HIGH QUALITY
TPR **CLEAR**

100% HIGH QUALITY
TPR **BLACK**

The Right Goggles feature a classic round lens shape. The lenses are also slightly curved which provides excellent peripheral vision. The TPR gaskets around the lenses form a comfortable, watertight seal around the eye socket. The lenses feature external anti-scratch treatment, UV protection and internal anti-fog treatment. The headband is made of 100% hypoallergenic silicone for maximum comfort and fit. The strap and buckle is also interchangeable with all other goggles and masks in the Cressi Swim Line.

SIZE B

5 INCH - 127 MM



REUSABLE PROTECTIVE BOX
cm 13.5x21



FOX

ADULT SIZE

- U.S. PAT 5.956.778
- MICROMETRIC ADJUSTABLE BUCKLE
- 100% ANTI UV LENS
- ANTI SCRATCH LENS
- ANTI FOG LENS
- 2 YEAR WARRANTY



CLEAR

BLACK



AQUAMARINE

WHITE



ASSORTED

COLOURS	PACK	CODE
FOX CLEAR	6	DE202160
FOX AQUAMARINE	6	DE202163
ASSORTED	12	DE202199
FOX BLACK	6	DE202150
FOX WHITE	6	DE202134

MADE IN
ITALY100% HIGH QUALITY
TPR **CLEAR**100% HIGH QUALITY
TPR **BLACK**

The sophisticated design of the Fox Goggles feature uniquely shaped flat lenses which combine fashionable style with perfect vision underwater.

The lenses are shatterproof and feature external anti-scratch treatment, UV protection and internal anti-fog treatment.

The Fox goggles feature comfortable TPR gaskets which form a watertight seal on the eyes and fit most facial profiles.

The silicone strap and micro-adjustable buckle system are interchangeable with all the other masks and goggles in the Cressi Swim Line.

SIZE C

5.25 INCH - 133 MM

REUSABLE PROTECTIVE BOX
cm 13.5x21

CRESSI

Cressi
swim

S W I M L I N E

BUYER'S GUIDE 2019



MINI COBRA

KID'S SWIM MASK  7-15 YEARS



- U.S. PAT 5.956.778
- TOTAL VISION
- MICROMETRIC ADJUSTABLE BUCKLE
- ULTRA CLEAR SKIRT
- 100% ANTI UV LENS
- ANTI SCRATCH LENS
- ANTI FOG LENS
- 2 YEAR WARRANTY



COLOURS	PACK	CODE
MINI COBRA CLEAR/LIME	6	DE202067
MINI COBRA CLEAR/BLUE	6	DE202022
MINI COBRA CLEAR/PINK	6	DE202040
MINI COBRA COLORAMA LIGHT BLUE/LIME	6	DE202021
MINI COBRA CLEAR/AZURE/AZURE LENSES	6	DE202023
ASSORTED	12	DE202000

100% HIGH QUALITY ULTRA CLEAR TPR CLEAR

Goggles with a single-piece skirt that is characterised by the presence of an elastic element within the structure that allows a perfect fit on most facial profiles. Shatterproof lenses with anti-scratch treatment, UV protection and internal anti-fog treatment. Indestructible, micrometrically adjustable buckles. Possibility of instantly replacing the buckle-strap structure with other models from the Cressi range. Special packaging maintains these characteristics over time.



SIZE B

4.50 INCH - 114 MM



REUSABLE PROTECTIVE BOX
cm 13.5x21



 **7-15 YEARS**

SIZE B KING CRAB
4.50 INCH - 114 MM



SIZE B ROCKS
4.50 INCH - 114 MM



SIZE B MINI COBRA
4.50 INCH - 114 MM



BALOO

KID'S SWIM MASK  2-7 YEARS



- U.S. PAT 5.956.778
- TOTAL VISION
- MICROMETRIC ADJUSTABLE BUCKLE
- ULTRA CLEAR SKIRT
- 100% ANTI UV LENS
- ANTI SCRATCH LENS
- ANTI FOG LENS
- 2 YEAR WARRANTY

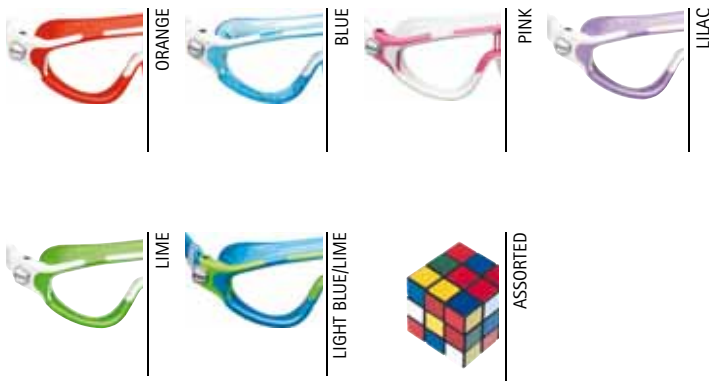

COLOURS	PACK	CODE
BALOO ORANGE	6	DE203285
BALOO BLUE	6	DE203220
BALOO PINK	6	DE203240
BALOO LILAC	6	DE203241
BALOO LIME	6	DE203267
BALOO LIGHT BLUE/LIME	6	DE203222
ASSORTED	12	DE203299

100% HIGH QUALITY TPR CLEAR

This SMALL-SIZE glass mono goggle is designed for children in order to allow any activity, also play, while maintaining excellent watertightness. The reduced skirt of its structure improves stability on the face as well as grip capacity.



SIZE A

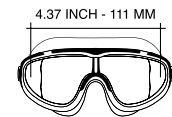

REUSABLE PROTECTIVE BOX
cm 13.5x21



 **2-7 YEARS**

SIZE A CRAB
4.25 INCH - 108 MM



SIZE A BALOO
4.37 INCH - 111 MM



ROCKS

KID'S GOGGLE  7-15 YEARS



- U.S. PAT 5.956.778
- MICROMETRIC ADJUSTABLE BUCKLE
- 100% ANTI UV LENS
- ANTI SCRATCH LENS
- ANTI FOG LENS
- 2 YEAR WARRANTY



BLUE



CLEAR



WHITE/BLUE



WHITE/PINK



ASSORTED

COLOURS	PACK	CODE
ROCKS BLUE	6	DE201321
ROCKS CLEAR	6	DE201360
ROCKS WHITE/BLUE	6	DE201332
ROCKS WHITE/PINK	6	DE201334
ASSORTED	12	DE201399

100% HIGH QUALITY
TPR **CLEAR**



SIZE B

4.50 INCH - 114 MM



REUSABLE PROTECTIVE BOX
cm 13.5x21



 **7-15 YEARS**

SIZE B KING CRAB
4.50 INCH - 114 MM



SIZE B ROCKS
4.50 INCH - 114 MM



SIZE B MINI COBRA
4.50 INCH - 114 MM



KING CRAB

KID'S GOGGLE  7-15 YEARS



- U.S. PAT 5.956.778
- MICROMETRIC ADJUSTABLE BUCKLE
- 100% ANTI UV LENS
- ANTI SCRATCH LENS
- ANTI FOG LENS
- 2 YEAR WARRANTY



COLOURS	PACK	CODE
KING CRAB LIME	6	DE202267
KING CRAB PINK	6	DE202240
KING CRAB LILAC	6	DE202241
KING CRAB CLEAR	6	DE202260
KING CRAB BLUE LIGHT	6	DE202263
KING CRAB ASSORTED	12	DE202299

100% HIGH QUALITY TPR CLEAR

The sophisticated design of the King Crab Goggles feature uniquely shaped flat lenses which combine fashionable style with perfect vision underwater. The lenses are shatterproof and feature external anti-scratch treatment, UV protection and internal anti-fog treatment. The King Crab goggles feature comfortable TPR gaskets which form a watertight seal on the eyes and fit most facial profiles. The silicone strap and micro-adjustable buckle system are interchangeable with all the other masks and goggles in the Cressi Swim Line.



SIZE B

4.50 INCH - 114 MM



REUSABLE PROTECTIVE BOX
cm 13.5x21



 **7-15 YEARS**

SIZE B KING CRAB
4.50 INCH - 114 MM



SIZE B ROCKS
4.50 INCH - 114 MM



SIZE B MINI COBRA
4.50 INCH - 114 MM



CRAB

KID'S GOGGLE  2-7 YEARS



- U.S. PAT 5.956.778
- MICROMETRIC ADJUSTABLE BUCKLE
- 100% ANTI UV LENS
- ANTI SCRATCH LENS
- ANTI FOG LENS
- 2 YEAR WARRANTY



LILAC



LIME



LIGHT BLUE



AZURE



PINK



CLEAR

AZURE LENSES



CLEAR



ASSORTED

COLOURS	PACK	CODE
CRAB LIME	6	DE203167
CRAB AZURE	6	DE203120
CRAB PINK	6	DE203140
CRAB LILAC	6	DE203141
CRAB CLEAR	6	DE203160
CRAB CLEAR/AZURE LENSES	6	DE203161
CRAB LIGHT BLUE	6	DE203122
ASSORTED	12	DE203199

100% HIGH QUALITY TPR CLEAR

Sophisticated silicone goggles specifically designed for children aged approximately between 3 and 7 years. Completely flat lenses for perfect vision even at the edges. Ideal for swim lessons Shatterproof lenses with UV protection and scratch-resistant external treatment and internal anti-fog treatment Cressi high technology for a perfect fit on most facial profiles and high comfort Intercambiabile strap instantly with patented buckles with micrometric adjustment and immediate, similar to those of the Cressi-sub diving masks Boy and Girl version.



SIZE A

4.25 INCH - 108 MM



REUSABLE PROTECTIVE BOX
cm 13.5x21



 **2-7 YEARS**

SIZE A CRAB
4.25 INCH - 108 MM



SIZE A BALOO
4.37 INCH - 111 MM



CRESSI

B A G S

BUYER'S GUIDE 2019

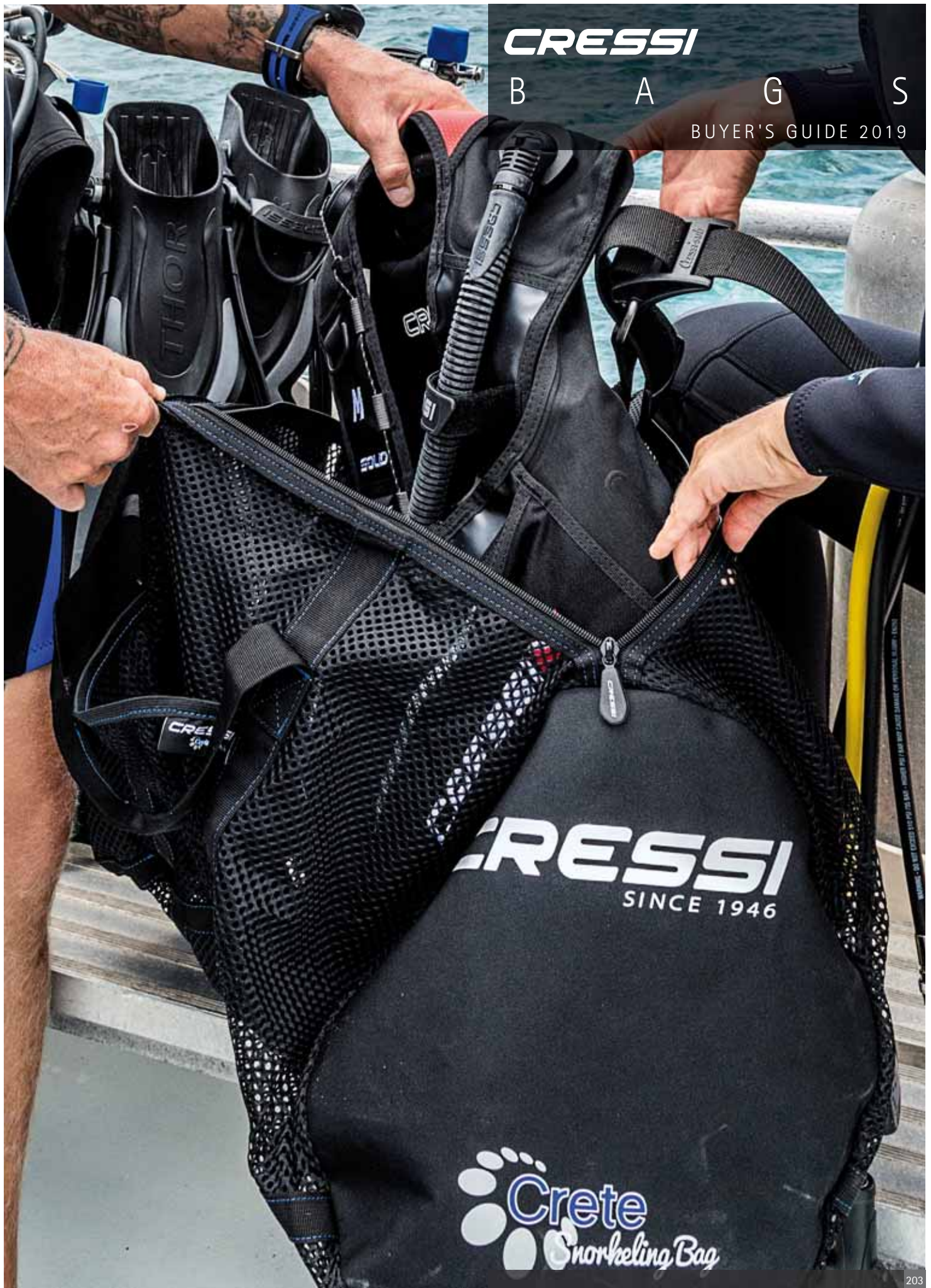

CRESSI
SINCE 1946

Crete
Snorkeling Bag

MOBY 5

115
LITERS

- 420 DENIER NYLON
- YKK ZIP

HIGH
VOLUME

CAPACITY: LT 115
WEIGHT: KG 3.9 - LBS 8.6
DIMENSIONS:
CM 76X40X28 - INCH 29.94X15.76X11.03

It is made from a new 300/400 denier material that is light yet very strong. The main compartment opens on three sides allowing easy access. There are two large bellows pockets to the front with zip closures, two side pockets for fins and a small upper pocket that holds an address tag. The reinforced pull handle is telescopic and fully retractable. The wheels have a large diameter and can be removed and easily replaced in the event of breakage.

There are two carrying handles: a reinforced one at the top and one with Velcro closure at the bottom. The back of the bag houses supporting rods to keep the Moby 5 in a vertical position. All the zips are very strong YKK

WITH
WHEELS

PRODUCT	CODE
MOBY 5	UB932200

MOBY LIGHT

ULTRALIGHT! ONLY 2.9 KG 

- 210 DENIER NYLON
- YKK ZIP



PRODUCT	CODE
MOBY LIGHT	UB932300

85
LITERS

IDEAL
FOR TRAVEL

CAPACITY: LT 85
WEIGHT: KG 2.9 - LBS 6.39
DIMENSIONS:
CM 75X40X30 - INCH 29.55X15.76X11.82

This good sized bag with wheels is the result of painstaking research aimed at reducing the weight of the bag for use when flying.

With a careful choice of equipment it is now possible to take all your diving equipment with you whilst remaining within the 15 kg baggage limit imposed by charter airlines. Moby light is made from 210 denier nylon fabric which is light yet, at the same time, very strong.

The single main compartment can be opened on three sides and is closed by a double YKK zip, ensuring easy access to the bag. At the back there is a small pocket for an address tag.

The reinforced pull handle is telescopic and fully retractable. The wheels can be removed and easily replaced in the event of breakage.

There are two carrying handles: a reinforced one at the top and one with Velcro closure at the bottom.



WITH
WHEELS



TURTLE

ULTRALIGHT! ONLY 2.8 KG 

**STRONG &
LIGHTWEIGHT**



RIGID CABIN
SIZE BAG

CAPACITY: LT 30
WEIGHT: KG 2.8 - LBS 6.17
DIMENSIONS:
CM 56X35X23 - INCH 22.06X13.79X9.06

MATERIALS:
OUTSIDE POLYCARBONATE
INSIDE 150D POLYESTER

This rigid suitcase is both ultralight (only 2,8 kg) and extremely resistant. Equipped with wheels and a combination lock, its crush-resistant shell makes it ideal for transporting shock-sensitive delicate equipment.

30
LITERS

IDEAL
FOR TRAVEL

PRODUCT	CODE
TURTLE RIGID TROLLEY BAG	UB951000



WITH
WHEELS



COMBI-LOCK
WITH TSA

VUELO

ULTRALIGHT! ONLY 2.8 KG 

YKK ZIP



CABIN
SIZE BAG

WATER
REPELLENT

CAPACITY: LT 43
WEIGHT: KG 2.8 - LBS 6.17
DIMENSIONS:
CM 52X36X23 - INCH 20.49X14.18X9.06

Vuelo is the trolley of the Cressi, designed especially for air travel. Maximum functionality and lightweight (only 2.8kg) without compromising on space.

43
LITERS

IDEAL
FOR TRAVEL



WITH
WHEELS



PRODUCT	CODE
VUELO	UB932400

360 REGULATOR BAG



Comfortable padded bag to transport regulators and instruments.
Fitted with shoulder strap.



PRODUCT	CODE
360 REGULATOR BAG	UB940000

SPACE



Padded backpack for sensitive equipment and personal effects.
Internal laptop sleeve, two front pockets and dual side mesh pockets. Made of abrasion resistant Cordura fabric.



PRODUCT	CODE
SPACE BLACK	UA925300
SPACE BLUE	XUA925320
SPACE GREEN	XUA925367



NOTEBOOK POCKET

GORILLA PRO

XL SIZE DRYBAG

- └ FOR GARA FINS
- └ HIGH FREQUENCY WELDING
- └ WATER RESISTANT ZIPPER



NEW

135
LITERS

DRYBAG

CAPACITY: LT 135
WEIGHT: KG 1.6 - LBS 3.5
DIMENSIONS: CM 95X34X42 INCH 37.4X13.4X16

"Oversized" version of Gorilla bag. Perfect for transporting long fins and bulky equipment. Additionally, it has a convenient watertight side pocket for objects that need to be protected from the water.

ELECTRONICALLY WELDED



SPECIAL RELEASE CAP



ZIPPED POCKET



PRODUCT	CODE
GORILLA PRO	UA925710
N GORILLA PRO CAMOU	XUA925799

DRY GARA

60
LITERS

DRY BAG

- └─ FOR GARA FINS
- └─ HIGH FREQUENCY WELDING
- └─ 2 X GUN-HOLDER



Comfortable watertight daypack made of black highly resistant PVC. It is the ideal bag for carrying your equipment in any challenging situation, even on a motorcycle. It has side fasteners for carrying spear guns and a special front pocket for storing long fins.



PRODUCT	CODE
DRY GARA	UA925800

JUNGLE

MILITARY STYLE DUFFLE BAG

- └─ 420 DENIER NYLON
- └─ YKK ZIP



DIMENSIONS:
CM 80x35x22 - INCH 31.52x13.79x8.67

Practical and roomy shoulder bag with high quality, reliability and durability, made of high strength material in military green, ideal for those who like to carry not only the necessary.

PRODUCT	CODE
JUNGLE	UA925600

GARA PREMIUM BAG

NEW



FRONT
POCKET



PRODUCT	CODE
GARA PREMIUM BAG	UB931081

GARA BASIC BAG

- FOR GARA FINN
- DURABLE NYLON MATERIAL

NEW

DIMENSIONS:
CM 94X24.5X17.5
INCH 37X9.6X6.9



PRODUCT	CODE
GARA BASIC BAG	US451031

GORGONA

CAN FIT A COMPLETE SCUBA SET

YKK ZIP



CAPACITY: LT 107
 WEIGHT: KG 0.75 - LBS 1.65
 DIMENSIONS:
 CM 38x38x96 INCH 14.96x14.96x37.79
 MATERIALS:
 70% POLYESTER MESH
 30% 600D POLYESTER PUX2
 YKK ZIPPERS

- Practical pocketable mesh bag.
- Travel mesh bag practical to carry or rinse the equipment
 - The length is sized to house even the longest freediving fins
 - Bag easily foldable for becoming a practical round bag with handle (diameter 38 cm - 14.96 inch)



BLACK



BLUE



PINK

PRODUCT	CODE
GORGONA BLACK	UA925900
GORGONA BLUE	XUA925920
GORGONA PINK	XUA925940



CRETE



NEW

CAPACITY: LT 64,5
 WEIGHT: KG 0,57 - OZ 20.30
 DIMENSIONS:
 CM 60XØ37 INCH 23.6XØ14.6



PRODUCT	CODE
CRETE BLACK/BLUE	UA929120

PALM

CAN FIT A COMPLETE SCUBA SET

**PRICE
REDUCTION!**



WEIGHT: KG 1.2 - LBS 2.53
 DIMENSIONS: MAIN COMPARTMENT
 CM 40x40x74 INCH 15.75x15.75x29.13
 CAPACITY 92 LT
 DIMENSIONS: FRONT POCKET
 CM 28.45x18x10.5 INCH 11.02x7.09x4.13
 CAPACITY 5.3 LT
 DIMENSIONS: FLAT POCKET INSIDE
 CM 27X68 INCH 10.63X26.77
 MATERIALS:
 80% PVC MESH, 20% 600D POLYESTER PUX2
 YKK ZIPPERS

- Mesh backpack with adjustable padded shoulder straps and adjustable sternum strap
- Two comfortable rubber handles make it easy to transport when used as a bag
- Side zipper with large opening (60 cm - 23.62 inch) for easy access to the main compartment with backpack fully loaded
- Large pocket inside and outside to house equipment or other items
- Plastic eyelets on the bottom of the compartments allow a fast water drainage

PRODUCT	CODE
PALM	UA925400

SWIM BAG

**PRICE
REDUCTION!**

Cressi
swim



Carry bag for swimming and pool accessories made from strong nylon. It is easy to access the main upper opening because it zips open right around three sides and has a double slide zipper. Two zip-up pockets have been placed along the narrow sides, one houses a waterproof pouch where you can stow wet garments and keep them apart from the rest of the bag. Front pocket on one of the long ends that has a pen holder, key snap-lock and several accessory pockets. Inside pocket for documents and valuables. Two carry handles, Velcro closing and adjustable shoulder strap with snap-locks.

PRODUCT	CODE
SWIM BAG	DA000010

CRESSI

A C C E S S O R I E S

BUYER'S GUIDE 2019



LUMIA

ULTRA LED DIVE LAMP



SWITCH WITH 3 POSITIONS
OFF
ON UNSTABLE WITH AUTOMATIC RETURN
ON

2 POWER LEVELS
210 LM / 18000 LUX
STANDARD USE
260 LM / 25000 LUX
SPEARFISHING USE

EXCELLENT ERGONOMICS
THANKS TO THERMOPLASTIC RUBBER COATING AND HIGHLY ASYMMETRIC DESIGN

NEUTRAL WHITE COLOR TEMPERATURE
SIMILAR TO SUNLIGHT FOR MAXIMUM RETURN OF THE COLORS
CRI > 75

NARROWED LIGHT BEAM
APPROXIMATELY 6° SPOT LIGHT BEAM THANKS TO TIR LENS



COLOURS	CODE
LUMIA BLACK	SJ550000
LUMIA YELLOW	SJ550010

C.R.I < 75

C.R.I > 75



LOW QUALITY LED

HIGH QUALITY CREE® LED

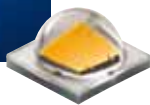

Torch with a highly asymmetric design boasts excellent ergonomics and a highly tactile perception of its geometric characteristics. Thanks to this particular design, the switch position is immediately found without needing to use your eyesight.

The porthole and body are coated with thermoplastic rubber to extend shelf life and reduce noises from impact when used for fishing. These ergonomic features are a big advantage over aluminum torches with a circular section which do not give feedback on the position of the grip and, in some cases, even require the use of two hands to turn it on. The switch has three positions: Off, On Unstable with Automatic Return, On.

The On Unstable position is particularly useful in fishing because it allows flashing by one simple press.

The strap with slider spring allows adjustment according to the user's needs, but being elastic can be pulled out in case of emergency.

Power is supplied by four AA "Stylus" batteries, either alkaline or rechargeable. The power supply has an electronic management system that eliminates the gap between the different electrical potentials of different types of batteries and ensures an efficiency of 30% higher than the commonly used systems.

Choice of two power levels.

The electronics system emits a warning signal on when to replace the batteries and is equipped with auto-shutdown, differentiated according to the power level you set, should it unwittingly be left on. The LED has a neutral white color temperature similar to sunlight for maximum return of the colors in the underwater environment.

The light beam of the LED is narrowed into a spot light beam of about 6° by means of a lens made of ultra-transparent material protected by the polycarbonate optical porthole. Batteries included.

WHAT IS A TIR LENS

The TIR lens collimates the LED light into efficient, well-controlled light beams that maximize the usable lumen in the target area with an absence of discomfort glare or shadows. The result is a smooth, high quality beam of superior intensity, uniformity, color over angle mixing designed by cressi for the best result.

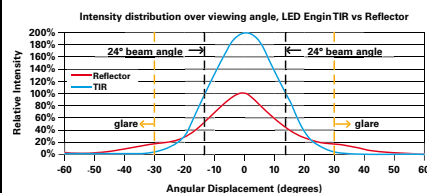

TIR LENS VS. REFLECTOR

The basic working principle is the same for both TIR lenses and reflectors, but TIR lenses have more control over light. With reflectors a big part of the light doesn't "touch" the reflector and this light can't be controlled in any way. This difference can easily be seen with tight spot optics as reflectors usually don't have as sharp a cutoff as TIR lenses.

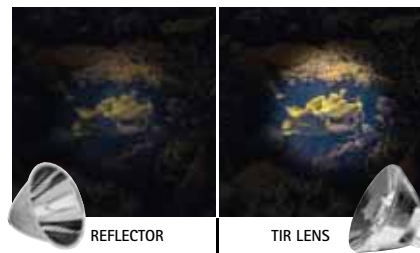

REFLECTOR
Reflectors produce much softer cut-off even if the viewing angle is same

TIR LENS
TIR lens' typical light distribution has a sharp cut-off.

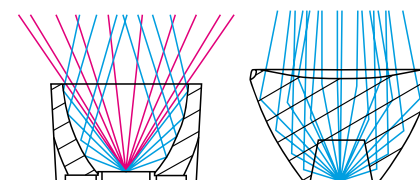

TANKS



5 LT

10 LT

12 LT

15 LT

18 LT

TEST GAUGE
BAR/PSI

M25x2

CRESSI SUB USES THE M 25x2 SPACING TO THREAD TANKS AND CONTROL VALVES IN CONFORMITY WITH EUROPEAN REGULATIONS. USING ARTICLES (TANKS/VALVES) WITH A DIFFERENT THREADING CAN CAUSE SERIOUS ACCIDENTS.



PRODUCT	CODE
CYLINDER 5 LT	GB840510
CYLINDER 10 LT	GB841010
CYLINDER 12 LT	GB841210
CYLINDER 15 LT	GB841510
CYLINDER 18 LT	GB841810
BACK PACK COMPL. 10/15/18	GB840050
TEST GAUGE INT	KK760000
TEST GAUGE DIN	KK760600

LIFTING BALLOONS

PRODUCT	CODE
HERCULES LIFTING BALLOON KG 250	KU745002
HERCULES LIFTING BALLOON KG 500	KU745003
HERCULES LIFTING BALLOON KG 1000	KU745004
HERCULES VALVE	KZ745099



GIANT



LENGTH BLADE
CM 17.8 - INCH 7.01

BLACK COATING
BLADE TREATMENT

TOTAL LENGTH
CM 30 - INCH 11.82



PRODUCT	CODE
GIANT	RC556500

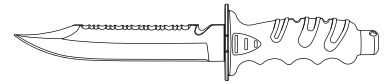

 JAPANESE
420 STEEL

Knife having large dimensions that make it particularly effective during use. Perfect as a work tool or for particularly intensive use.



ORCA

 MADE IN
ITALY

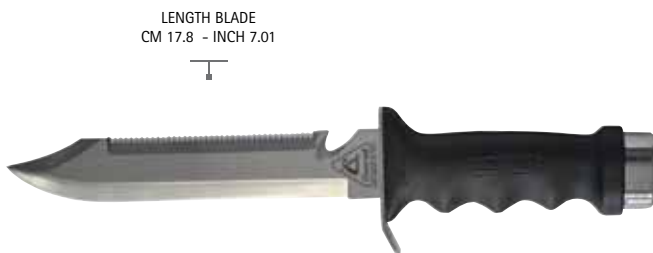

LENGTH BLADE
CM 17.8 - INCH 7.01

THICKNESS BLADE
MM 5.5 - INCH 0.22

TOTAL LENGTH
CM 30 - INCH 11.82

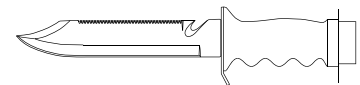

This legendary product has been around for years and years and has now become a sought-after collector's item. It is considerably heavy and large, perfect for a work tool, which this knife is designed to be. The large blade is forged from special steel, with a smooth edge on one side and partly serrated on the other. This side of the blade has a line cutter at the handle end. The anatomical, non-slip handle is made from soft grip material for a comfortable grip and comes with anatomical moulding for the fingers to fit into. On the back, it ends with a chrome-plated knob that can also be used as a mallet. The front of the handle ends with a stainless steel hilt to protect the fingers. The sheath is made from plastic and has a traditional elastic band to hold on the knife. It also has loops to attach the knife to your leg or onto your belt and comes with two leg straps.



PRODUCT	CODE
ORCA	RC556000

BORG



PRODUCT	CODE
BORG	RC559100
N! BORG BLACK BLADE	XRC569150

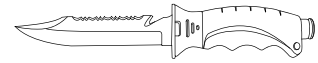

 JAPANESE
420 STEEL

Borg is a modern, large knife with a futuristic design and a strong, tempered blade.

- One side of the stainless steel blade is straight-edged, the other one is serrated right along the blade; they are both very sharp and effective for line cutting.
- Sheath with locking mechanism to allow one-hand release.
- It is separated from the blade by a small technopolymer thumb tab.
- The knife comes with two, standard issue straps to attach it to your leg.



FINISHER

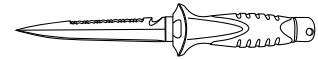
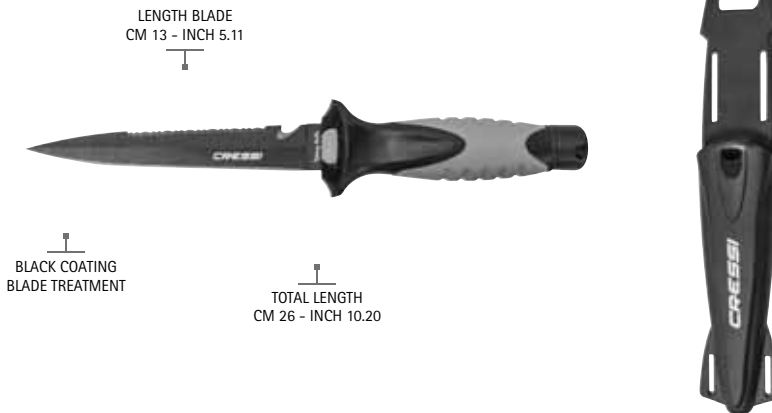

 JAPANESE
420 STEEL

Finisher is a modern, large knife with a futuristic design and a strong, tempered blade.

- One side of the stainless steel blade is straight-edged, the other one is serrated right along the blade; they are both very sharp and effective for line cutting.
- Sheath with locking mechanism to allow one-hand release.
- It is separated from the blade by a small technopolymer thumb tab.
- The knife comes with two, standard issue straps to attach it to your leg.



PRODUCT	CODE
FINISHER	RC559300

VICTORY

DROP POINT BLADE

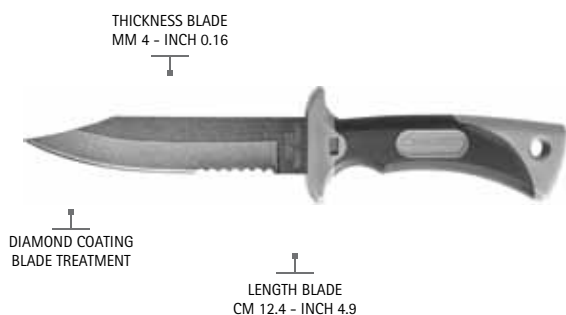

PRODUCT	CODE
VICTORY	RC557100

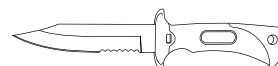

 JAPANESE
420 STEEL

 DIAMOND
COATING

- Japanese 420 Stainless Steel
- Sharp Tip
- Easy Grip and Impact Resistant rubber molded handle with Sheath and Adjustable Straps
- Secure Lock Plastic Sheath for Leg, Tank or BCD
- Light weight
- Ideal for scuba diving and spearfishing



SUPERTOTEM

MADE IN
ITALY

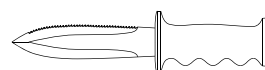

An inexpensive, average-size knife with an excellent quality-price ratio.

One side of the stainless steel blade is straight-edged, the other one is serrated right along the blade; they are both very sharp and effective for line cutting.

The anatomic grip is made from technopolymers and has a series of moulds for the fingers, ending with a thumb protection tab at the blade end.

The plastic sheath holds the knife firmly with a traditional elastic band and has loops to attach it to the leg or strap. The knife comes with two, standard issue straps to attach it to your leg.

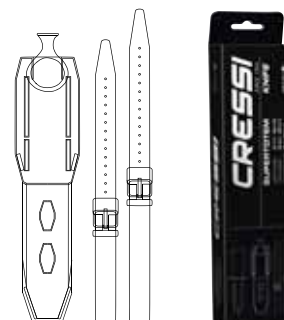

PRODUCT	CODE
SUPERTOTEM	RC550000

NORGE

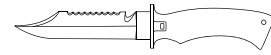
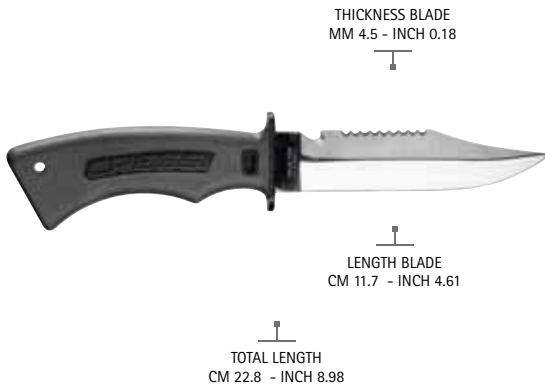

Norge is a modern, compact knife with a futuristic design and a strong, tempered blade. The anatomical, non-slip handle is made from soft grip material. It is separated from the blade by a small technopolymer thumb tab. The blade is made from special tempered stainless steel, with a smooth edge on one side and partly serrated on the other. This side of the blade has a line cutter at the handle end. The black technopolymer sheath comes with loops to attach it to leg or at the waist. The blade hooks onto the sheath with a quick-release spring slide that sits smoothly against the actual sheath. The knife comes with two, standard issue straps to attach it to your leg.



PRODUCT	CODE
NORGE	RC553010

SKORPION

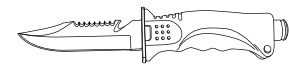
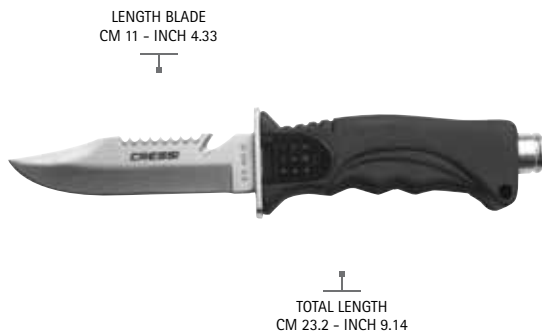

 JAPANESE
420 STEEL

Skorpion is a modern, medium-sized knife with a futuristic design and a strong, tempered blade.

- One side of the stainless steel blade is straight-edged, the other one is serrated right along the blade; they are both very sharp and effective for line cutting.
- It is separated from the blade by a small technopolymer thumb tab.
- Sheath with locking mechanism to allow one-hand release.
- The knife comes with two, standard issue straps to attach it to your leg



PRODUCT	CODE
SKORPION	RC559000

VIGO

LENGTH BLADE
CM 11 - INCH 4.33



TOTAL LENGTH
CM 23.5 - INCH 9.25



PRODUCT	CODE
VIGO	RC555000

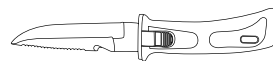

Blades are made from stainless steel specifically made for the marine environment
- Sheath with locking mechanism to allow one-hand release.
- The knife comes with two, standard issue straps to attach it to your leg



KILLER

WEIGHT KNIFE
ONLY GR 120 - OUNCES 4.23

LENGTH BLADE
CM 8.6 - INCH 3.39



THICKNESS BLADE
MM 3-5 - INCH 0.12 - 0.2

TOTAL LENGTH
CM 18 - INCH 7.09

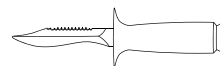

A small knife that's been around for years now, highly appreciated because it is easy to handle and the blade penetrates really well.
This is forged from a single piece of stainless steel, and is blocked at the grip by a screw knob situated at the end of the grip. One side of the blade has a smooth cutting edge, the other is partly serrated. The anatomical technopolymer grip ends at the blade with a thumb tab. The sheath is made from plastic and has a traditional elastic band to hold on the knife and loops to attach the knife to your leg or onto your belt. The knife comes with two, standard issue straps to attach it to your leg.

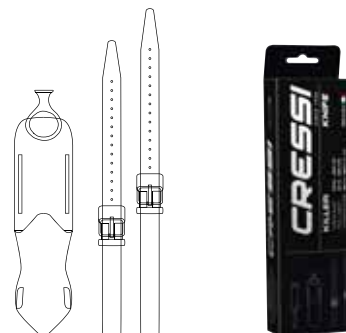

PRODUCT	CODE
KILLER	RC554000

GRIP

INCLUDING BOTH ARA AND APNEA KIT

LENGTH BLADE
CM 8 - INCH 3.1



TOTAL LENGTH
CM 17.50 - INCH 6.9



Grip is a small-sized knife with a tapered blade that makes it ideal for spearfishing and scuba diving.

REAR PLATE FOR BC STRAP ATTACHMENT



2 RUBBER STRAP MOUNTS

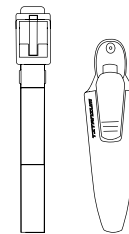

PRODUCT	CODE
GRIP	RC559400

GRIP BLUNT TIP

LENGTH BLADE
CM 7.30 - INCH 2.80



TOTAL LENGTH
CM 17.50 - INCH 6.9

NEW



REAR PLATE FOR BC STRAP ATTACHMENT



- HOSE ATTACHMENT INCLUDED
- BC MOUNT STRAPS INCLUDED

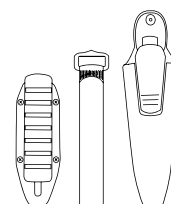

PRODUCT	CODE
GRIP BLUNT TIP	RC559410

PREDATOR

WEIGHT KNIFE
ONLY GR 120 - OUNCES 4.23

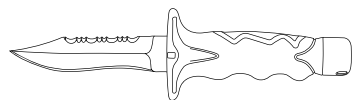

 JAPANESE
420 STEEL

Small knife, very handy and anatomical. Its dimensions make it particularly suitable to be stored as a spare knife, or for divers who like to gear up in a practical and effective way.



PRODUCT	CODE
PREDATOR	RC554500

LAMA

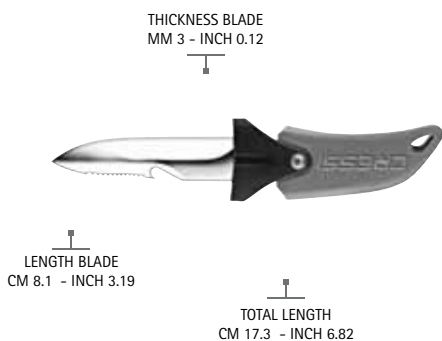

INCLUDING
BOTH ARA
AND
APNEA KIT

MADE IN
ITALY

PRODUCT	CODE
LAMA ARA+APNEA	RC552500
KIT LAMA APNEA	RZ550011
KIT LAMA ARA	RZ550010

KIT LAMA ARA



KIT LAMA APNEA



Small, flat and ergonomic knife, with quick-release extraction system that prevents accidental loss of the knife, since you need to press two release points on the sheath at the same time to get it out. Ergonomic rubbersoft handle, with high attrition coefficient, for secure grip. Double hilt thumb tab and hole on the handle, to hook it onto a safety line. The blade is made from special, tempered stainless steel. One side has a smooth edge and the other is partly serrated, complete with a line cutter. Lama Apnea knife comes with a sheath to attach it to your weight belt, or onto your leg, using the classic straps.

DIVECUTTER TITANIUM

It is the perfect tool to cut with maximum efficiency and in an almost intuitive way, fishlines, nets and ropes, up to 10 mm diameter! with just one cut.

It has one sheet of just 12x4 cm with ergonomic design made of anodized aluminium, in which it is inserted a stainless steel industrial blade with a titanium coating, with similar dimensions to the classical "Sevillanas" blades used for shaving, but with a thickness three times greater.

It maintains intact its cutting capacity during many dives and even after using the same blade hundreds of times.

The case is designed to be used either over the belt, straps of the jacket, hoses or on the inflator hose by clamps.

Divecutter extraction is extremely fast because it is based on a very simplified Velcro® system that requires one only movement to have the Divecutter on the hand. In case the Velcro® is accidentally unhooked, the pressure of the case is enough to avoid its loss.



NEW



TITANIUM BLADE



PRODUCT	CODE
DIVE CUTTER	RC555005

MAIN KNIVES SPARE PARTS

FOR THE FULL LIST,
SEE OUR
SPARE PARTS
CATALOGUE



KNIVES SPARE PARTS	CODE
KNIFE BLACK STRAPS (PAIR)	RZ550097
HOLDER FOR KILLER KNIFE	RZ550008
HOLDER FOR TOTEM/ORCA	RZ551007
SHEATH W/STRAPS FOR ORCA	RZ550003
SHEATH W/STRAPS FOR SUPERTOTEM	RZ550004
SHEATH W/STRAPS FOR NORGE	RZ550005
SHEATH W/STRAPS FOR KILLER	RZ550006



KNIVES
COMPARISON
CHART

Giant Orca Borg Finisher Victory Supertotem Norge Skorpion Vigo Predator Killer Grip Lama

TONDA BUOY

- NYLON COVER + 0.25 MM INNER BLADDER
- 20 M LINE
- BRIGHT RED COLOR FOR MAXIMUM VISIBILITY
- 3 POCKETS
- 3 POCKETS A SAFETY WHISTLE



Conceived to serve as a sturdy, highly durable surface marker buoy, also for use when diving from the shore. Of compact design, this buoy uses two casings: an outer skin, made of abrasion-resistant material, which is bright red for enhanced visibility, ensures excellent protection for the inner inflatable chamber, which is white. A casing for the pole of the highly visible flag pursuant to regulations, is provided in the centre of the float. A black rubber coated mesh covering the bottom of the buoy protects it from abrasions and lets water drain easily so that the buoy retains its light weight at all times. Two pockets closed by velcro straps house two weights that ensure stability even in rough sea conditions, making for excellent visibility as the buoy invariably maintains its position at the top of fully formed waves. Two large-sized rings are provided to hook up the line as well as another accessory. An opening at the top makes it possible to insert the "air chamber", which is then inflated via an ad hoc pocket. Another casing with velcro closure may be used to store small items and big easy-to-use handles are provided along the sides of the buoy. Also red in colour, the line is about 20m long and is fitted with two plastic snap hooks. This buoy comes with a convenient whistle: an additional safety device that can be used to attract attention in an emergency situation.



PRODUCT	CODE
TONDA BUOY	TA611502

EASY BUOY

- 0.35 MM PVC
- NEW SHAPE
- INNOVATIVE NEW WRAP-AROUND SYSTEM
- 20 M LINE



First-ever buoy to feature a built-in flag, it is fitted with a specially designed casing for the line that prevents the line from tangling up and makes it possible to adjust its length as a function of how deep you want to go. Weights are built into its structure to ensure stability even in rough sea conditions, making for excellent visibility as the buoy invariably retains its position at the top of fully formed waves. It has no protruding parts and once the line has been released, if you are using an end weight, your position will be marked out automatically. Pursuant to the regulations, its prevailing colour is red with a white stripe for immediate recognisability. Also red in colour, the line is about 20m long and is fitted with two plastic snap hooks. This buoy comes with a convenient whistle: an additional safety device that can be used to attract attention in an emergency situation.



PRODUCT	CODE
EASY BUOY	TA611501

COMPETITION FLOAT

- └ 0.35 MM PVC
- └ CLASSIC ROUND BUOY
- └ BRIGHT RED COLOR FOR MAXIMUM VISIBILITY



A spherical shaped buoy made of PVC, slightly flattened to reduce wind resistance and provided with inflatable built-in flag. On the underside a ring allows to hook up the supplied 25 m long floating line together with the small ballast weight of 150 g (total weight 380 g, height 23+32 cm, diameter 30 cm).

PRODUCT	CODE
COMPETITION FLOAT	TA611500

MARKER BUOY

- └ 0.35 MM PVC



PRODUCT	CODE
MARKER BUOY	TA611800

SWIM BUOY



PRODUCT	CODE
SWIM BUOY	TA611981

SIGNAL BOARD

- └ PVC WITH MESH COVER
+ 0.25 MM INNER BLADDER
- └ 20 M LINE
- └ CARRYING HANDLE
- └ FLAG WITH 40 CM POLE
- └ BRIGHT RED COLOR
FOR MAXIMUM VISIBILITY
- └ 4 POCKETS
- └ SAFETY WHISTLE



PRODUCT	CODE
SIGNAL BOARD	TA611902

SPYDER BOARD

- └ BRIGHT RED COLOR
FOR MAXIMUM VISIBILITY
- └ FLAG WITH 40 CM POLE
- └ 3 POCKETS



PRODUCT	CODE
SPYDER SURFACE BOARD	TA611900

TORPEDO FLOAT

- └ BRIGHT RED COLOR
FOR MAXIMUM VISIBILITY
- └ CLASSIC TORPEDO SHAPED BUOY
- └ 0.35 MM PVC



PRODUCT	CODE
TORPEDO FLOAT	TA611600

"MARSEILLAS" ELASTIC BELT



PRODUCT	CODE
MARSEILLAS ELASTIC BELT	TA626000

QUICK-RELEASE ELASTIC BELT

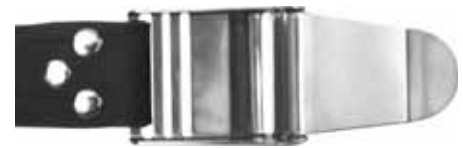

PRODUCT	CODE
QUICK-RELEASE ELASTIC BELT	TA626010

WEIGHT BELT



PRODUCT	CODE
WEIGHT BELT BLACK	TA625000

ANKLE WEIGHTS

300
GR

PRODUCT	CODE
ANKLE WEIGHTS	TA200001

LEAD WEIGHT

1
KG

PRODUCT	CODE
LEAD WEIGHT	TA620100

NET BAG

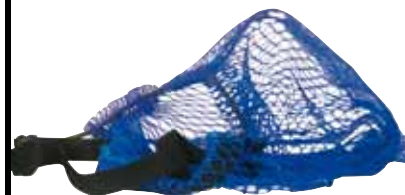

PRODUCT	CODE
NET BAG	TA615000

BUOY ROPE
FOLDER

PRODUCT	CODE
BUOY ROPE FOLDER	TA613000N

SPECIAL CEMENT

BLACK NEOPRENE GLUE



PRODUCT	CODE
SPECIAL CEMENT	TA650000

MULTIPURPOSE
HANGER

NEW



PRODUCT	CODE
MULTIPURPOSE HANGER	TA700001

MAGNETIC
OCTOPUS HOLDER

NEW



PRODUCT	CODE
MAGNETIC OCT. HOLD.	TA700002

DRY BOX

NEW



PRODUCT	CODE
DRY BOX	TA700003

A full-page underwater photograph showing a diver in silhouette, oriented upside down, against a bright light source from the surface. Sunlight rays create a dramatic, hazy atmosphere. The foreground is filled with dark, textured seaweed or coral.

CRESSI

SPEARFISHING

BUYER'S GUIDE 2019

OUR CHAMPIONS

11 Times Spearfishing World Champions

- | | |
|-------------------------|-----------------|
| - 1957 Catalani | - 1989 Mazzarri |
| - 1959 Lentz | - 1992 Mazzarri |
| - 1960 De Otero Hermann | - 2004 Bellani |
| - 1963 De Otero Hermann | - 2010 Gospic |
| - 1971 Choque | - 2014 Blanco |
| - 1987 Mazzarri | |

Join us on CRESSI Spearfishing 

KIOWA CUSTOM

THE FIRST FULLY CUSTOMIZABLE CRESSI SPEARGUN



COMES WITH:

- 2 DIFFERENT MUZZLES
- NO BANDS
- NO SHAFTS



METALLIC MECHANISM



STAINLESS
STEEL
RELEASE BOX
AND TRIGGER



LATERAL
GUIDE LINE RELEASE
WITH AUTOMATIC
RETURN



INTERCHANGEABLE
HIGH-LOW
STERNAL SUPPORT

CUSTOMIZABLE

- BANDS PAGE 246
- SHAFTS PAGE 248

MAGNETIC SPEAR LOCK
2 MAGNETS IN A WATERTIGHT CHAMBER



MAGNETIC HEAD (1)



QUICK LOADING
MAGNETIC OPEN MUZZLE

AND



AND ULTRA COMPACT
CLOSED MUZZLE (2)

28 mm diameter barrel made of black Anticorodal aluminium with shaft guide and anti-deflection reinforcement along the bottom. Handle with two interchangeable sternum supports and stainless steel boxed mechanism with Teflon components to minimise friction. Retractable stainless steel slide ring on the side. Big fishing reel. Open muzzle with double circular bands and magnetic shaft positioning system. The bands can be added/removed quickly and effortlessly without having to take down/fit back any component. A unique feature of the Kiowa custom is that the core components of the speargun, i.e., its handle, barrel and muzzle, are sold without the shaft and the bands, enabling underwater fishing aficionados to customise it with specific components for the type of fishing they like.

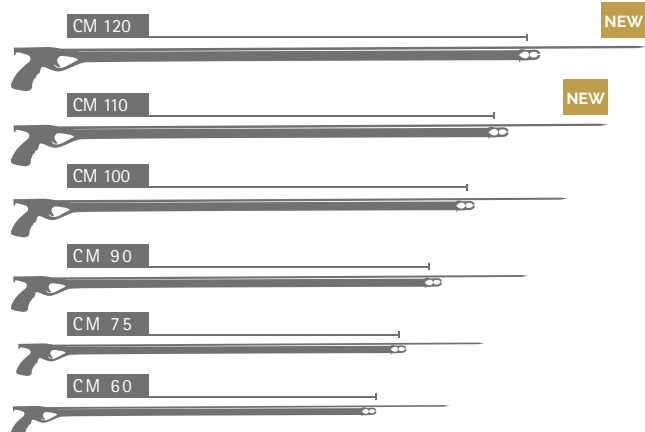

PRODUCT	SIZE	CODE
N! KIOWA CUSTOM	cm 120	FE370500
N! KIOWA CUSTOM	cm 110	FE370400
KIOWA CUSTOM	cm 100	FE370300
KIOWA CUSTOM	cm 90	FE370200
KIOWA CUSTOM	cm 75	FE370100
KIOWA CUSTOM	cm 60	FE370000

RIGGED AND REINFORCED
BARREL WITH SHAFT GUIDE



CHEROKEE OCEAN

CATCH THE BIG FISH!





CHEROKEE HEAD

MAGNETIC SPEAR LOCK
2 MAGNETS IN A WATERTIGHT CHAMBER

CHEROKEE HANDLE

STAINLESS STEEL RELEASE BOX AND TRIGGER

LATERAL GUIDE LINE RELEASE WITH AUTOMATIC RETURN

INTERCHANGEABLE HIGH-LOW STERNAL SUPPORT

READY FOR USE
assembled with:

- MULTIFILAMENT BRAIDED NYLON
- SHOCK ABSORBER

QUICK LOADING MAGNETIC OPEN MUZZLE

SHOCK ABSORBER

DOUBLE CIRCULAR BAND Ø MM 16 WITH LINED WISHBONE

HYDROFORMED RIGGED BARREL WITH SHAFT GUIDE
28 mm

SHAFT WITH FINS Ø MM 7

Anticorodal hydroformed frame improved with integrated spear guide. The particular shape of the frame provides excellent hydrodynamics and considerable resistance to bending. Anticorodal handle has soft interchangeable high-low sternal support. Release box made entirely of stainless steel with lateral guide line release having automatic return and buckling tooth stroke damper. Tilting lateral safety catch. Reinforced reel buckle with steel through pin. Head for double elastic with magnetic spear lock: as soon as the spear is put in place, it is held by two magnets mounted in a watertight chamber. This characteristic guarantees the maximum speed of reset without the disadvantages of conventional mechanical restraint systems. Supplied assembled and ready for use, multifilament braided nylon and 7 mm spear with small high 17-4 PH steel fins.



PRODUCT	SIZE	CODE
CHEROKEE OCEAN	cm 120	FE362500
CHEROKEE OCEAN	cm 110	FE362400
CHEROKEE OCEAN	cm 100	FE362300
CHEROKEE OCEAN	cm 90	FE362200

CHEROKEE OPEN

CHEROKEE
HEAD



MAGNETIC SPEAR LOCK
2 MAGNETS IN A WATERTIGHT CHAMBER

READY FOR USE

- assembled with:
- MULTIFILAMENT BRAIDED NYLON
 - SHOCK ABSORBER



CHEROKEE HANDLE



STAINLESS
STEEL
RELEASE BOX
AND TRIGGER



LATERAL
GUIDE LINE RELEASE
WITH AUTOMATIC
RETURN



INTERCHANGEABLE
HIGH-LOW
STERNAL SUPPORT

Anticorrosion brown camouflaged frame improved with integrated spear guide and lower anti-bending reinforcement, handle has sternal support with a soft interchangeable high-low position. Release box made entirely of stainless steel with lateral guide line release having automatic return and buckling tooth stroke damper. Tilting lateral safety catch. Reinforced reel buckle with steel through pin. Head for double elastic with magnetic spear lock: as soon as the spear is put in place, it is held by two magnets mounted in a watertight chamber. This characteristic guarantees maximum speed of reset without the disadvantages of conventional mechanical restraint systems. Supplied assembled and ready for use, multifilament braided nylon and 6.5 mm spear with small 17-4 ph steel fins.

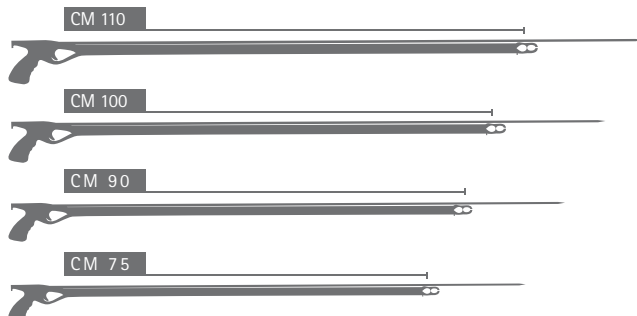

PRODUCT	SIZE	CODE
CHEROKEE OPEN	cm 110	FE361400
CHEROKEE OPEN	cm 100	FE361300
CHEROKEE OPEN	cm 90	FE361200
CHEROKEE OPEN	cm 75	FE361100

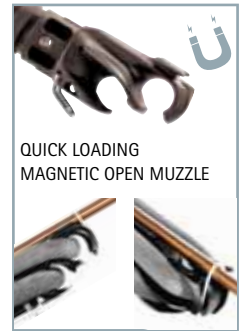

QUICK LOADING
MAGNETIC OPEN MUZZLE



SHOCK ABSORBER



CIRCULAR BAND
WITH LINED WISHBONE



RIGGED AND REINFORCED
BARREL WITH SHAFT GUIDE

28
mm

CAMOUFLAGE TREATMENT



SHAFT WITH FINS Ø MM 6.5



CHEROKEE

CHEROKEE HEAD



MAGNETIC SPEAR LOCK
2 MAGNETS IN A WATERTIGHT CHAMBER

READY FOR USE

assembled with:
- MULTIFILAMENT BRAIDED NYLON

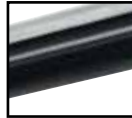

NEW INTEGRATED SHAFT GUIDE



QUICK LOADING
MAGNETIC OPEN MUZZLE

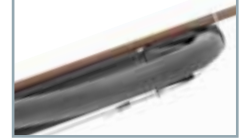

CIRCULAR
BAND Ø MM 16

CHEROKEE HANDLE



STAINLESS
STEEL
RELEASE BOX
AND TRIGGER



LATERAL
GUIDE LINE RELEASE
WITH AUTOMATIC
RETURN



INTERCHANGEABLE
HIGH-LOW
STERNAL SUPPORT

Anticorrosional black frame with integrated spear guide, grip made of engineering plastic reinforced with glass fibre, high or low soft sternal support. Trigger mechanism made entirely in stainless steel with automatic return and buckling tooth stroke damper. Reversible side-safety mechanism. Reinforced reel with steel pin buckle.

Head for double elastic with magnetic spear lock: as soon as the spear is put in place, it is held by two magnets mounted in a watertight chamber. This characteristic guarantees maximum speed of reset without the disadvantages of conventional mechanical restraint systems.

RIGGED BARREL
WITH SHAFT GUIDE



SHAFT Ø MM 6

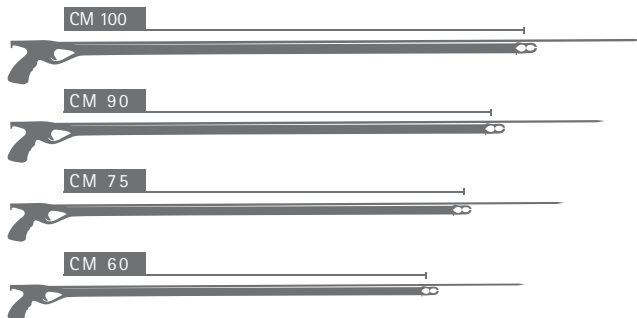

PRODUCT	SIZE	CODE
CHEROKEE	cm 100	FE360300
CHEROKEE	cm 90	FE360200
CHEROKEE	cm 75	FE360100
CHEROKEE	cm 60	FE360000

PACIFIC

READY FOR USE
assembled with:
- MULTIFILAMENT BRAIDED NYLON



Traditional "Comanche"
handle paired with a modern head
for dual circular sling.

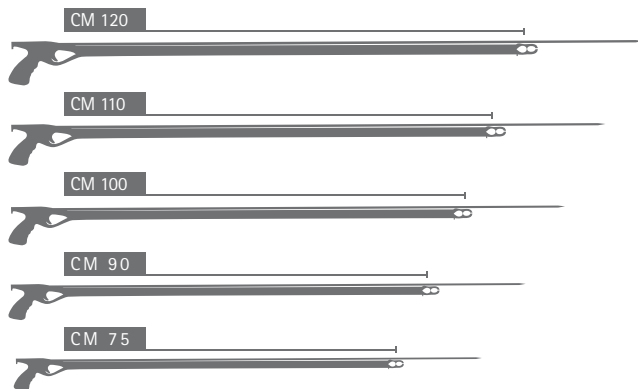

PRODUCT	SIZE	CODE
PACIFIC	cm 120	FE358500
PACIFIC	cm 110	FE358400
PACIFIC	cm 100	FE358300
PACIFIC	cm 90	FE358200
PACIFIC	cm 75	FE358100

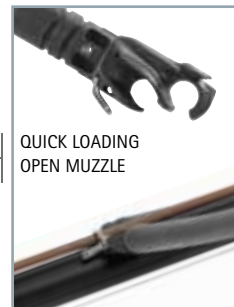
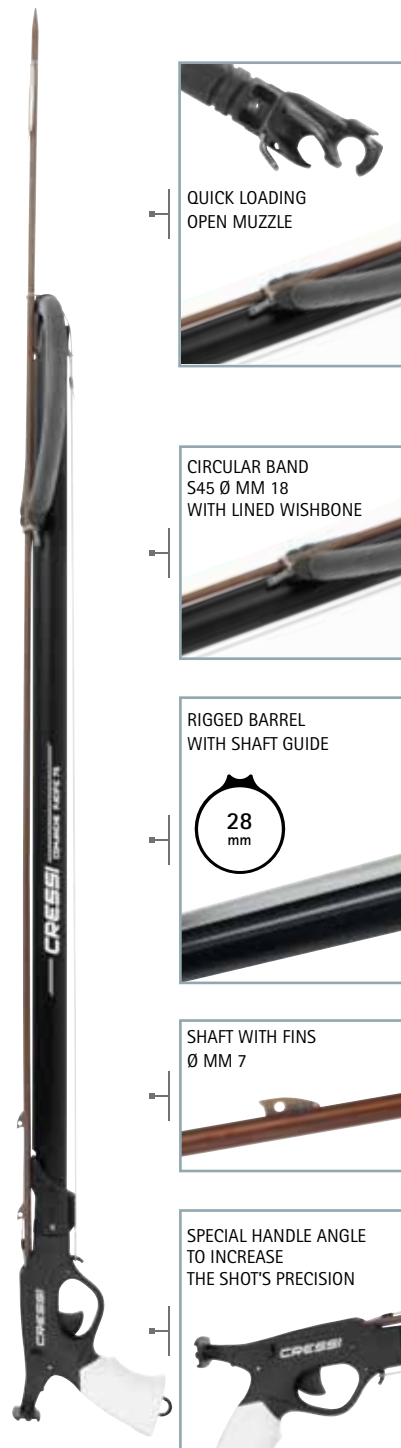

QUICK LOADING
OPEN MUZZLE

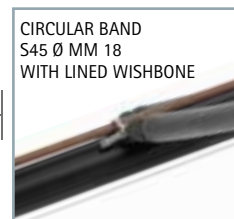

CIRCULAR BAND
545 Ø MM 18
WITH LINED WISHBONE



RIGGED BARREL
WITH SHAFT GUIDE

28
mm



SHAFT WITH FINS
Ø MM 7



SPECIAL HANDLE ANGLE
TO INCREASE
THE SHOT'S PRECISION

COMANCHE RAIL



NEW QUICKLOAD
MINI SPEARHEAD



NEW
INTEGRATED
SHAFT GUIDE

28
mm

Comanche's much appreciated tried and tested grip, together with an anticorodal aluminium frame with integrated shaft guide and the new QuickLoad mini spearhead make it the most precise and practical speargun out there, particularly for charging. The reel is attached by dovetail joint. It is possible to assemble the speargun band.

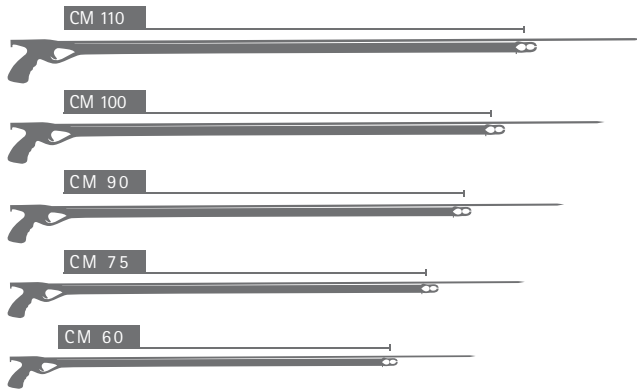

PRODUCT	SIZE	CODE
COMANCHE RAIL	cm 110	FE359400
COMANCHE RAIL	cm 100	FE359300
COMANCHE RAIL	cm 90	FE359200
COMANCHE RAIL	cm 75	FE359100
COMANCHE RAIL	cm 60	FE359000

READY FOR USE
assembled with:
- MULTIFILAMENT BRAIDED NYLON



ULTRA COMPACT
CLOSED MUZZLE



STANDARD
BAND Ø MM 16



RIGGED BARREL
WITH SHAFT GUIDE

28
mm



SHAFT Ø MM 6



SPECIAL HANDLE ANGLE
TO INCREASE
THE SHOT'S PRECISION



MOICANO

OUR MOST VERSATILE GUN

CRESSI
Specialized
Retailer-Product

MADE IN
ITALY



READY FOR USE
assembled with:
- MULTIFILAMENT BRAIDED NYLON

Barrel with integrated shaft guide for more precise shooting.
- Camouflage for stalking.
- Very small muzzle to facilitate aim.
- Regular and circular bands mount.
- Anatomical white grip featuring small chest loading pad.
- Articulated wishbone.

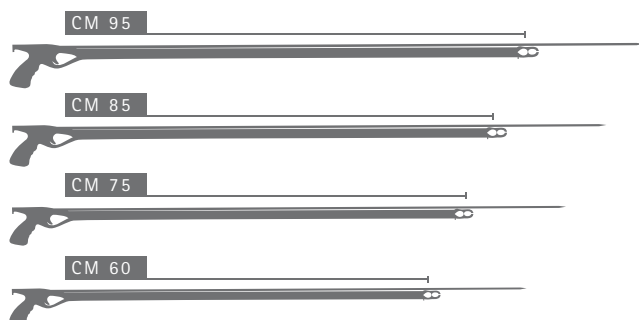

PRODUCT	SIZE	CODE
MOICANO	cm 95	FE343095
MOICANO	cm 85	FE343085
MOICANO	cm 75	FE343075
MOICANO	cm 60	FE343060



ULTRA COMPACT
CLOSED MUZZLE



STANDARD BAND
Ø MM 16



RIGGED AND REINFORCED
BARREL WITH SHAFT GUIDE

26
mm

CAMOUFLAGE TREATMENT



SHAFT Ø MM 6



SPECIAL HANDLE ANGLE
TO INCREASE
THE SHOT'S PRECISION

YUMA



Yuma is a weapon designed and built for fast fishing.
Thanks to its open muzzle for dual circular slings, it makes it possible to reload extremely quickly and offers very intuitive aim.
- Barrel (Ø26) with integrated shaft guide for more precise shooting.
- Navy Camouflage NAVY for stalking.
- Anatomical white grip with a mini-handle for loading.

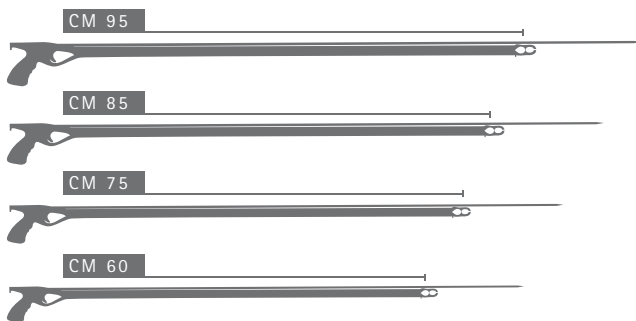

PRODUCT	SIZE	CODE
YUMA	cm 95	FE344095
YUMA	cm 85	FE344085
YUMA	cm 75	FE344075
YUMA	cm 60	FE344060

READY FOR USE
assembled with:
- MULTIFILAMENT BRAIDED NYLON

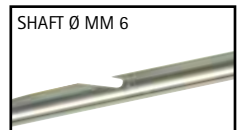
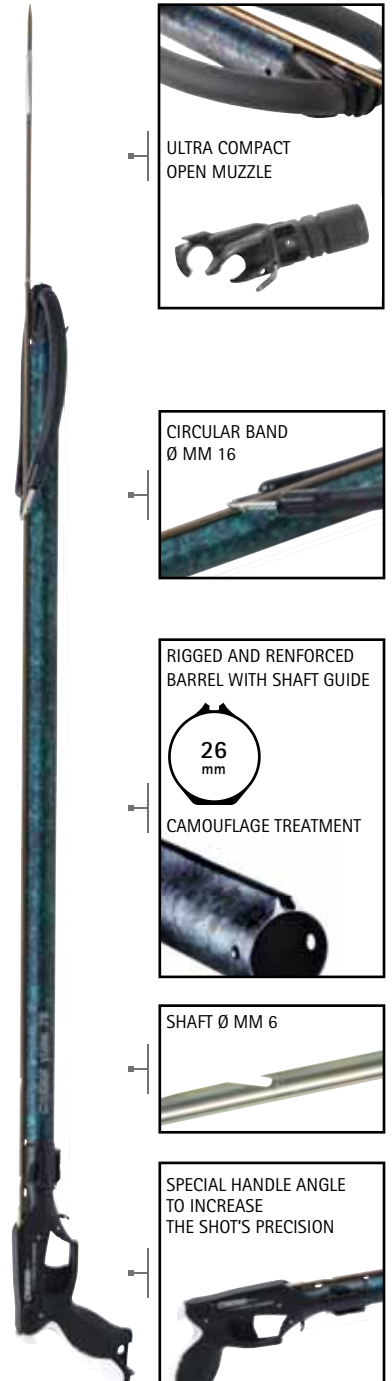

SIOUX

MADE IN
ITALY

Tried and tested and effective spear guns, the strengths of Sioux guns lie in the excellent materials used, their reliability, the easy firing and the favourable quality-price ratio.

The barrel is made from light, non-deformable anti-corroding aluminium.

The inclination of the handgrip is designed for perfect firing and for quick, instinctive aiming; this is covered in rubbersoft. The trigger system is very gentle and progressive, and is fitted with a safety catch. A strong ring for the line comes out of the bottom of the handgrip, and at the front there are 2 line releasing devices, the dovetail trigger for the reel and a somewhat advanced spear-rail saddle.

The muzzle has 13 mm standard bands complete with simple arched wishbones with a right ratio between loading ease and forward thrust. The muzzle is set for possible use of a second circular band. The 6 mm diameter shaft comes with a single wing and two weapon notches. Sioux comes in the following lengths:

50 (barrel 45 cm, 60 (barrel 55 cm), 75 cm



PRODUCT	SIZE	CODE
SIOUX	cm 75	FE347500
SIOUX	cm 60	FE346000
SIOUX	cm 50	FE345000



CLOSED MUZZLE

STANDARD BAND
Ø MM 1328
mm

SHAFT Ø MM 6.50

SPECIAL HANDLE ANGLE
TO INCREASE
THE SHOT'S PRECISION

APACHE

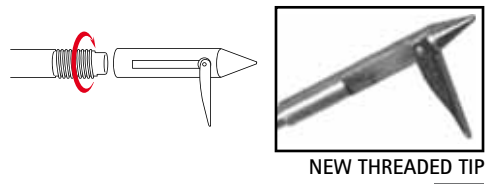

APACHE is Cressi's entry level speargun and can also be handy used as a second gun. This gun is an excellent choice where fishing in holes, around rocks, shallows and where the quarry is in close proximity. The APACHE incorporates a closed muzzle, which helps with ease of loading and improved accuracy. The sealed barrel is anodized for enhanced corrosion resistance, while the ergonomic molded handle permits easier maneuverability and quick muzzle pointing. The power band is fitted with a standard stainless wishbone and the gun includes a threaded tip shaft

- Ergonomic molded handle for easier maneuverability
- Durable anodized heavy duty sealed aluminum barrel
- Closed muzzle for improved accuracy and ease of loading
- Replaceable band and wishbone assembly is user friendly

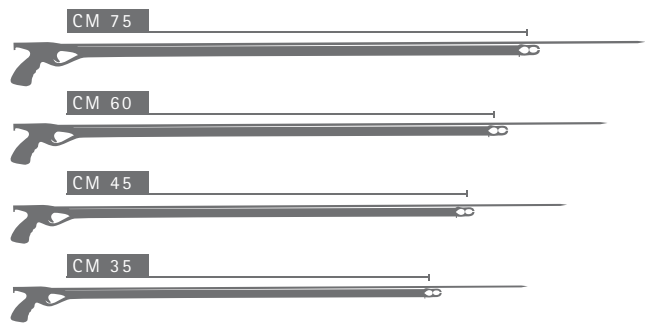

PRODUCT	SIZE	CODE
APACHE	cm 75	FE341075
APACHE	cm 60	FE341060
APACHE	cm 45	FE341045
APACHE	cm 35	FE341035



SAETTA PRO



VACUUM SEALED MUZZLE



This speargun features a special offset, hermetically sealed muzzle, enabling the shaft to be loaded without flooding the interior of the barrel. In this manner, the piston does not have to expel the water from the interior and can apply the entire power of the gun onto the shaft. The result is an extremely fast and precise shooting action, such as had never been realised on a pneumatic speargun. The grip handle set at a special angle facilitates aiming and control. It is soft and white coloured to facilitate locating the gun on the seafloor.

SAETTA PRO WITH POWER REDUCER



PRODUCT	SIZE	CODE
SAETTA PRO with reducer	cm 110	FS409910
SAETTA PRO with reducer	cm 88	FS408800
SAETTA PRO with reducer	cm 70	FS407000

TECHNICAL FEATURES

- Power reducer.
- Sizes: 70, 88, 110 cm.
- Patented, sealed muzzle of compact design.
- Vacuum seals can be replaced without having to unload the shaft.
- Tahitian shaft in 17-4PH steel with highly hydrodynamic tip, 7.5 mm in diameter.
- Viewfinder of new design with steel insert.
- Bigger-sized shaft tip.
- Piston of new design for improved shaft action, speed, and precision release.
- New slide ring.
- Sold ready for use with multifilament thread.

OFFSET BARREL



SLIDING PISTON AND TRIGGER HOOK

13 mm
13 MM
INTERNAL
BARREL

SHAFT Ø MM 7,5 17-4 PH

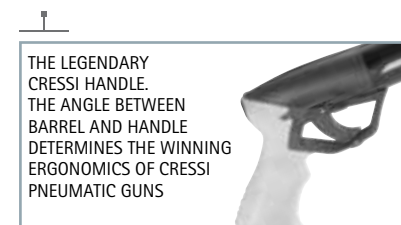

THE LEGENDARY
 CRESSI HANDLE.
 THE ANGLE BETWEEN
 BARREL AND HANDLE
 DETERMINES THE WINNING
 ERGONOMICS OF CRESSI
 PNEUMATIC GUNS

SAETTA



PRODUCT	SIZE	CODE
SAETTA	cm 70	FR387000
SAETTA	cm 55	FR385500
SAETTA	cm 40	FR384000

PRODUCT	SIZE	CODE
SAETTA with reducer	cm 110	FS389910
SAETTA with reducer	cm 88	FS388800
SAETTA with reducer	cm 70	FS387000
SAETTA with reducer	cm 55	FS385500



SIGHT LINE

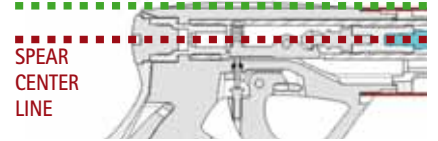

SL STAR



PRODUCT	SIZE	CODE
SL STAR	cm 70	FR377000
SL STAR	cm 55	FR375500
SL STAR	cm 40	FR374000

PRODUCT	SIZE	CODE
SL with reducer	cm 100	FS364500
SL with reducer	cm 70	FS362500
SL with reducer	cm 55	FS361500



DRY GUN BAG



- 840 DENIER NYLON
- YKK ZIP



PRODUCT	CODE
DRY GUN BAG	UA926200



MULTIPRONGS

WITH Ø MM 7.00 THREADS >>> FIT ON Ø MM 7.00 AND Ø MM 8.00 SHAFTS



3
POINTS
STAINLESS
STEEL INOX



4
POINTS
TEMPERED



3
POINTS
TEMPERED



4
POINTS
BURNISHED



5
POINTS
STAINLESS
STEEL INOX



PRODUCT	CODE
MUTLIPRONG NYLON 3 POINTS STAINLESS STEEL	FA390008
MUTLIPRONG NYLON 4 POINTS TEMPERED	FA390011
MUTLIPRONG NYLON 3 POINTS TEMPERED	FA390015
MUTLIPRONG NYLON 4 POINTS BURNISHED	FA390014
MUTLIPRONG NYLON 5POINTS STAINLESS STEEL	FA390016

REEL R20 - R30 - R50



DOVETAIL MOUNTING SYSTEM

- KIOWA - CHEROKEE OCEAN - CHEROKEE OPEN - CHEROKEE - PACIFIC - COMANCHE RAIL - YUMA - MOICANO - SIOUX

20
METERS



NEW

30
METERS



50
METERS



	PRODUCT	CODE
N!	REEL R20	FA359020
	REEL R30	FA359030
	REEL R50	FA359050

FISHING REEL



DOVETAIL MOUNTING SYSTEM

- KIOWA - CHEROKEE OCEAN - CHEROKEE OPEN - CHEROKEE - PACIFIC - COMANCHE RAIL - YUMA - MOICANO - SIOUX



	PRODUCT	CODE
	FISHING REEL	FA359001

GUNS ACCESSORIES

WISHBONE STANDARD



CODE
FA350022

JOINTED WISHBONE TYPE A



CODE
FA350020

JOINTED WISHBONE TYPE B



CODE
FA350023

MULTIFILAMENT



CODE
FA354525

COMPETITION THREAD NYLON



CODE
FA354522

COMPETITION THREAD NYLON



CODE
FA354524

SPEAR HEAD

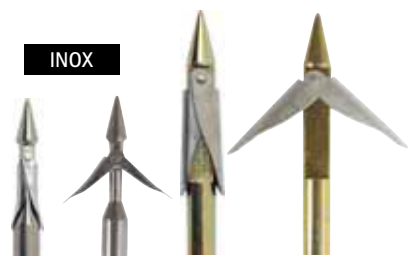

PRODUCT	CODE
INOX MINI	FA390001
MACH	FA390004

SHAFT REFLOATER



CODE
FA354523

SHAFT LOADER



CODE
FA390018

GUNS ACCESSORIES

SHOCK ABSORBER



CODE

FA354603

PROLONGED
COMPETITION WINGS

CODE

FA354520

GAUGE FOR GUNS

SL/SL STAR - SAETTA

MADE IN
ITALY

SL/SL STAR



SAETTA

PRODUCT	CODE
SL/SL STAR	FA390020
SAETTA	FA390032

SILICONE SPRAY

ML 200



CODE

FA390025

FISHING HOOK



CODE

FA354521

HAND PUMP

SL/SL STAR - SAETTA

MADE IN
ITALY

SL/SL STAR



SAETTA

PRODUCT	CODE
SL/SL STAR	FA320060
SAETTA	FZ370073

LINE

MT 200 - Ø MM 2

MADE IN
ITALY

CODE

FA353035

HIGH TENACITY LINE

MT 200 - Ø MM 2,5

MADE IN
ITALY

CODE

FA390030

SPEAR GUN OIL

ML 100

ML
100

CODE

FA390022

CIRCULAR BAND

CHEROKEE OCEAN - CHEROKEE OPEN - CHEROKEE - YUMA - PACIFIC - APACHE

HOW-TO VIDEOS
[YouTube](#) [vimeo](#)

CIRCULAR BAND WITH LINE WISHBONE



Ø MM
18

Ø MM
16

**S45
PLUS**



GUNS	SIZE	MM	CODE
75 CM	48 CM	18	FA400113
85-90 CM	57 CM	18	FA400114
95-100 CM	63 CM	18	FA400115
105-110 CM	69.5 CM	18	FA400116

GUNS	SIZE	MM	CODE
75 CM	48 CM	16	FA400153
90 CM	57 CM	16	FA400154
100 CM	63 CM	16	FA400155
110 CM	69.5 CM	16	FA400156
120 CM	77 CM	16	FA400157

CIRCULAR BAND G20



Ø MM
19.5



GUNS	SIZE	CODE
85/90 CM	50 CM	FA400204
95/100 CM	55 CM	FA400205
105/110 CM	62 CM	FA400206
115/120 CM	70 CM	FA400207

CIRCULAR BAND S45 PLUS



Ø MM
18



GUNS	SIZE	CODE
75 CM	45 CM	FA400103
85/90 CM	50 CM	FA400104
95/100 CM	55 CM	FA400105
105/110 CM	62 CM	FA400106
115 /120 CM	70 CM	FA400107

CIRCULAR BAND

Ø MM
16

Ø MM
13



GUNS	SIZE	MM	CODE
60 CM	34 CM	16	FA400302
75 CM	45 CM	16	FA400303
85-90 CM	50 CM	16	FA400304
95-100 CM	55 CM	16	FA400305

GUNS	SIZE	MM	CODE
35 CM	26 CM	13	FA340019
50 CM	31 CM	13	FA340020
60 CM	34 CM	13	FA340021
75 CM	39 CM	13	FA340022

STANDARD BAND

MOICANO - COMANCHE RAIL - SIOUX

STANDARD BAND G20

Ø MM
19.5



GUNS	SIZE	CODE
55/60 CM	16 CM	FA400032
75 CM	18.5 CM	FA400033
82/84 CM	20 CM	FA400034
85/90 CM	22 CM	FA400035
95/100 CM	25.5 CM	FA400036
105/110 CM	27.5 CM	FA400037

STANDARD BAND S45 PLUS

Ø MM
18



GUNS	SIZE	CODE
45/50 CM	14 CM	FA400021
55/60 CM	16 CM	FA400022
75 CM	18.5 CM	FA400023
82/84 CM	20 CM	FA400024
85/90 CM	22 CM	FA400025
95/100 CM	25.5 CM	FA400026
105/110 CM	27.5 CM	FA400027

STANDARD BAND

Ø MM
16



GUNS	SIZE	CODE
45/50 CM	14 CM	FA400001
55/60 CM	16 CM	FA400002
75 CM	18.5 CM	FA400003
82/84 CM	20 CM	FA400004
85/90 CM	22 CM	FA400005
95/100 CM	25.5 CM	FA400006
105/110 CM	27.5 CM	FA400007

STANDARD BAND

Ø MM
13



GUNS	SIZE	CODE
50 CM	13 CM	FA340006
60 CM	17 CM	FA340007
75 CM	24 CM	FA340008

SLING GUNS SHAFTS



INOX SHAFT WITH FINS



Ø MM
7.00



ORIGINAL EQUIPMENT FOR	SIZE	CODE
CHEROKEE OCEAN/PACIFIC 75	115 CM	FA405103
CHEROKEE OCEAN/PACIFIC 90	130 CM	FA405104
CHEROKEE OCEAN/PACIFIC 100	140 CM	FA405105
CHEROKEE OCEAN/PACIFIC 110	150 CM	FA405106
CHEROKEE OCEAN/PACIFIC 120	160 CM	FA405107

INOX SHAFT WITH FINS



Ø MM
6.50



Heat treated, tempered stainless steel, finned, flopper style spear shaft. Uses three fins for easier loading in lieu of notches.

ORIGINAL EQUIPMENT FOR	SIZE	CODE
CHEROKEE OPEN 75	115 CM	FA405003
CHEROKEE OPEN 90	130 CM	FA405004
CHEROKEE OPEN 100	140 CM	FA405005
CHEROKEE OPEN 110	150 CM	FA405006
-	160 CM	FA405007

INOX 174 PH SHAFT



Ø MM
6.50



SIZE	CODE
90 CM	FA410502
105 CM	FA410503
115 CM	FA410504
125 CM	FA410505
130 CM	FA410506
140 CM	FA410507
150 CM	FA410508

INOX 174 PH SHAFT



Ø MM
6.00



The original Cressi shafts, in 6 mm and 6.5 mm versions offer exceptional durability due to the special steel construction. They are highly resistant to shock and bending.

ORIGINAL EQUIPMENT FOR	SIZE	CODE
COMANCHE RAIL 60/MOICANO 60/ YUMA 60	90 CM	FA410002
CHEROKEE 60/MOICANO 75/ YUMA 75	105 CM	FA410003
COM. RAIL 75/CHER. 75/ MOI. 85/ YUMA 85	115 CM	FA410004
MOICANO 95/ YUMA 95	125 CM	FA410005
COMANCHE RAIL 90/CHEROKEE 90	130 CM	FA410006
COMANCHE RAIL 100/CHEROKEE 100	140 CM	FA410007
COMANCHE RAIL 110	150 CM	FA410008

SLING GUNS SHAFTS



STEEL SHAFT

Ø MM
6.50

Notched, flopper style spear shaft.



ORIGINAL EQUIPMENT FOR	SIZE	CODE
-	65 CM	FA340000
SIOUX 50	75 CM	FA340001
SIOUX 60	90 CM	FA340002
SIOUX 75	105 CM	FA340003

STEEL THREADED SHAFT

Ø MM
6.50

Notched and threaded shafts to allow a harpoon or spear head to be attached. Will accept any Cressi threaded spear tip.

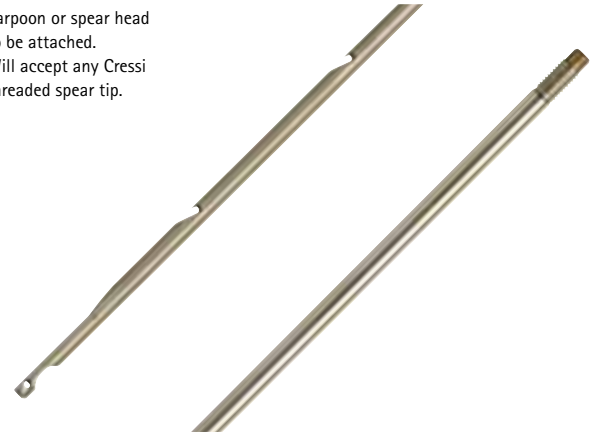

ORIGINAL EQUIPMENT FOR	SIZE	CODE
APACHE 35	55 CM	FA350535
APACHE 45	65 CM	FA350545
APACHE 60	75 CM	FA350560
APACHE 75	90 CM	FA350575
-	105 CM	FA350590

PNEUMATIC GUNS SHAFTS

INOX THREADED SHAFT

Tempered steel shaft for Cressi pneumatic spearguns. Threaded to fit any Cressi threaded spear tip.

Ø MM
8.00



SIZE	CODE
36.5 CM	FA360030
55 CM	FA360031
68.5 CM	FA360032
87.5	FA360034
99.5 CM	FA360033
109.5	FA360035

THREADED SHAFT

For Cressi pneumatic spearguns, threaded to fit any Cressi threaded spear tip.

Ø MM
8.00



ORIGINAL EQUIP.	SIZE	CODE
SAETTA/STAR 40	36.5 CM	FA360036
SAETTA/SL/STAR 55	55 CM	FA361036
SAETTA/SL/STAR 70	68.5 CM	FA362036
SAETTA 88	87.5	FA363036
SL 100	99.5 CM	FA365036
SAETTA 110	109.5	FA366036

INOX 174 PH SHAFT

These shafts offer exceptional durability due to the special steel construction. They are highly resistant to shock and bending.

Ø MM
7.50



ORIGINAL EQUIP.	SIZE	CODE
SAETTA PRO 70	77 CM	FA372000
SAETTA PRO 88	95 CM	FA373000
SAETTA PRO 110	117 CM	FA376000

SEPPIA

3.5-5-7mm

- 3.5 MM BLACK METALLITE NEOPRENE
- 5-7 MM SUPERSOFT OPEN-CELL NEOPRENE
- PADDED CHEST REINFORCEMENT
- HIGH WAISTED TROUSERS

NEW

Wetsuit created with the exclusive new Cressi green / brown camouflage, computer-designed to make it more difficult for prey to create solid images, thereby confusing the wearer with the background. Preformed anatomical cut. Jacket with padded reinforcement on the chest. Smooth skin with watertight seals on hood, wrists and ankles. Reinforced anti-abrasion lining on the chest and knees. High-waisted trousers with watertight seals on the ankles and waist.

CHEST REINFORCEMENT



SMOOTH SKIN WATERTIGHT SEALS



KNEEPAD



SINGLE-PIECE UNDERARM SECTION

BLACK METALLITE

OPEN CELL

JACKET - 3.5mm

SIZE	CODE
S/2	LE468002
M/3	LE468003
L/4	LE468004
XL/5	LE468005
XXL/6	LE468006

PANTS - 3.5mm

SIZE	CODE
S/2	LE468102
M/3	LE468103
L/4	LE468104
XL/5	LE468105
XXL/6	LE468106

JACKET - 5mm

SIZE	CODE
S/2	LE468202
M/3	LE468203
L/4	LE468204
XL/5	LE468205
XXL/6	LE468206

PANTS - 5mm

SIZE	CODE
S/2	LE468302
M/3	LE468303
L/4	LE468304
XL/5	LE468305
XXL/6	LE468306

JACKET - 7mm

SIZE	CODE
S/2	LE468402
M/3	LE468403
L/4	LE468404
XL/5	LE468405
XXL/6	LE468406

PANTS - 7mm

SIZE	CODE
S/2	LE468502
M/3	LE468503
L/4	LE468504
XL/5	LE468505
XXL/6	LE468506

CORVINA

5-7mm

- TWO - PLY NEOPRENE
- OPEN CELL NEOPRENE
- CHEST REINFORCEMENT
- HIGH WAISTED TROUSERS



Wetsuit featuring Cressi's new Camouflage material with Black/Grey colour tones. For effortless breathing and wearability, the most sensitive areas use a new smooth, dual layer neoprene called "Two-Ply Neoprene", which is highly flexible, has great thermal power, and at the same time is very sturdy and durable. This neoprene in fact has a 1 mm thick outer layer and a 4 mm dual inner layer separated by a structural elastic lining. Thanks to this technology, it may be sewn to obtain strong seams and will not tear. The wetsuit benefits from a zone system, named "Self Adjusting System", that facilitates breathing and at the same time ensures excellent insulation, even in a strong wind. The design is rigorously anatomical. Protective reinforcement on sternum and knees.



EXT: 1 MM SMOOTH SKIN



INT: 4 MM OPEN CELL NEOPRENE

SINGLE-PIECE
UNDERARM
SECTION

JACKET - 5mm

SIZE	CODE
S/2	LE467202
M/3	LE467203
L/4	LE467204
XL/5	LE467205
XXL/6	LE467206

JACKET - 7mm

SIZE	CODE
S/2	LE467402
M/3	LE467403
L/4	LE467404
XL/5	LE467405
XXL/6	LE467406

PANTS - 5mm

SIZE	CODE
S/2	LE467302
M/3	LE467303
L/4	LE467304
XL/5	LE467305
XXL/6	LE467306

PANTS - 7mm

SIZE	CODE
S/2	LE467502
M/3	LE467503
L/4	LE467504
XL/5	LE467505
XXL/6	LE467506

NEW



SCORFANO LIQUID SEAL TECHNOLOGY

5-7mm

- ULTRASOFT NEOPRENE
- CHEST REINFORCEMENT
- HIGH WAISTED TROUSERS



A LAYER OF POLYMER IS SPREAD ALONG THE SEAMS TO PROTECT AND SEAL THEM, THEREBY INCREASING THE RESISTANCE TO WEAR, THE LIFETIME OF THE SUIT AND ITS INSULATING POWER



This suit features a special seams and protection system called the "Liquid Ultraseal System".

A layer of polymer is spread along the seams to protect and seal them, thereby increasing the resistance to wear, the lifetime of the suit, and its insulating power. 5- and 7-mm open-cell "Green-mimetic" neoprene. Preformed anatomical cut. BC with padded chest reinforcement, watertight seals, and Powertex waist. Watertight seals at the wrists and waist, Powertex reinforcement on the knees.

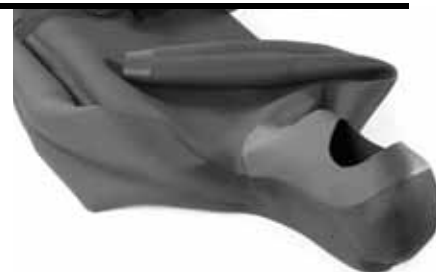

SUPER SOFT OPEN-CELL NEOPRENE

JACKET - 5mm

SIZE	CODE
S/2	LE466002
M/3	LE466003
L/4	LE466004
XL/5	LE466005
XXL/6	LE466006

JACKET - 7mm

SIZE	CODE
S/2	LE466202
M/3	LE466203
L/4	LE466204
XL/5	LE466205
XXL/6	LE466206

PANTS - 5mm

SIZE	CODE
S/2	LE466102
M/3	LE466103
L/4	LE466104
XL/5	LE466105
XXL/6	LE466106

PANTS - 7mm

SIZE	CODE
S/2	LE466302
M/3	LE466303
L/4	LE466304
XL/5	LE466305
XXL/6	LE466306

GLOVES
AND SOCKS
SEE PAGE 256



TRACINA

3.5-5-7mm

- ULTRASOFT NEOPRENE
- 3.5 MM BLACK METALLITE NEOPRENE
- 5-7 MM SUPERSOFT OPEN-CELL NEOPRENE
- CHEST REINFORCEMENT
- HIGH WAISTED TROUSERS



Wetsuit created with the exclusive new Cressi camouflage Dark Digital Specter Pat, computer-designed to make it more difficult for prey to create solid images, thereby confusing the wearer with the background. Preformed anatomical cut. Jacket with padded reinforcement in the chest, Smoothskin watertight seals on the hood, wrists, and waist, and reinforced Powertex lining at the elbows and waist. High-waisted trousers with watertight Smoothskin seals at the ankles and waist, and Powertex reinforcements on the knees. Camouflage color: Dark-Specter.

GLOVES
AND SOCKS
SEE PAGE 256



JACKET - 3.5mm

SIZE	CODE
S/2	LE464802
M/3	LE464803
L/4	LE464804
XL/5	LE464805
XXL/6	LE464806

PANTS - 3.5mm

SIZE	CODE
S/2	LE464902
M/3	LE464903
L/4	LE464904
XL/5	LE464905
XXL/6	LE464906

JACKET - 5mm

SIZE	CODE
S/2	LE465002
M/3	LE465003
L/4	LE465004
XL/5	LE465005
XXL/6	LE465006

PANTS - 5mm

SIZE	CODE
S/2	LE465102
M/3	LE465103
L/4	LE465104
XL/5	LE465105
XXL/6	LE465106

JACKET - 7mm

SIZE	CODE
S/2	LE465202
M/3	LE465203
L/4	LE465204
XL/5	LE465205
XXL/6	LE465206

PANTS - 7mm

SIZE	CODE
S/2	LE465302
M/3	LE465303
L/4	LE465304
XL/5	LE465305
XXL/6	LE465306

APNEA CAMOU

3.5-5-7mm

- BLACK METALLITE NEOPRENE
- CRESSI CAMOUFLAGE COLOR: BLACK / GREY
- HIGH WAISTED TROUSERS
- CHEST REINFORCEMENT

NEW

A well-cut wetsuit with particular attention to comfort around the areas where the body suffers most friction. Internal layer in black metallite and with a thickness of 3.5, 5 and 7 mm. New design of the chest-pad for a better protection during the loading of the speargun. Special knee-pads for extra protection.



KNEEPAD



TWO PIECES wetsuit man - 3.5mm

SIZE	CODE
S/2	LE450402
M/3	LE450403
L/4	LE450404
XL/5	LE450405
XXL/6	LE450406

TWO PIECES wetsuit man - 5mm

SIZE	CODE
S/2	LE450502
M/3	LE450503
L/4	LE450504
XL/5	LE450505
XXL/6	LE450506

TWO PIECES wetsuit man - 7mm

SIZE	CODE
S/2	LE450602
M/3	LE450603
L/4	LE450604
XL/5	LE450605
XXL/6	LE450606



APNEA

3.5-5-7mm

- BLACK METALLITE NEOPRENE
- CHEST REINFORCEMENT
- HIGH WAISTED TROUSERS

A well-cut suit with particular attention to comfort around the areas where the body suffers most friction.
Internal layer in metallic black and a thickness of 3,5 mm, 5 mm and 7 mm.
New design of the loading/reloading chestplate and special kneepads for extra protection.



TWO PIECES wetsuit man - 3.5mm

SIZE	CODE
S/2	LE450102
M/3	LE450103
L/4	LE450104
XL/5	LE450105
XXL/6	LE450106

TWO PIECES wetsuit man - 5mm

SIZE	CODE
S/2	LE450202
M/3	LE450203
L/4	LE450204
XL/5	LE450205
XXL/6	LE450206

TWO PIECES wetsuit man - 7mm

SIZE	CODE
S/2	LE450302
M/3	LE450303
L/4	LE450304
XL/5	LE450305
XXL/6	LE450306



BACK WEIGHT



Ballast holder backplate:
with quick release buckles and 6 handy
pockets for traditional ballast or spherical
lead weights. The high density neoprene
eliminates trim variations
and ensures better weight retention.
Quick release on the belt.

UP TO 6 KGS

PRODUCT	CODE
BACK WEIGHT	LE500000

CAMOUFLAGE GLOVES

ELASTIC-SPAN NEOPRENE

3mm



SCORFANO
CAMOUFLAGE
GREEN DIGITAL SPECTER PAT

3 MM

SIZE	CODE
S	LX478001
M	LX478002
L	LX478003
XL	LX478004



TRACINA
CAMOUFLAGE
DARK DIGITAL SPECTER PAT

3 MM

SIZE	CODE
S	LX477501
M	LX477502
L	LX477503
XL	LX477504

CAMOUFLAGE SOCKS

ELASTIC-SPAN NEOPRENE

3mm



SCORFANO
CAMOUFLAGE
GREEN DIGITAL SPECTER PAT

3 MM

SIZE	EU	CODE
S	36-38	LX433301
M	39-40	LX433302
L	41-43	LX433303
XL	44-46	LX433304



TRACINA
CAMOUFLAGE
DARK DIGITAL SPECTER PAT

3 MM

SIZE	EU	CODE
S	36-38	LX433201
M	39-40	LX433202
L	41-43	LX433203
XL	44-46	LX433204

CRESSI

CONCEPT STORE

BUYER'S GUIDE 2019

CRESSI
SINCE 1946

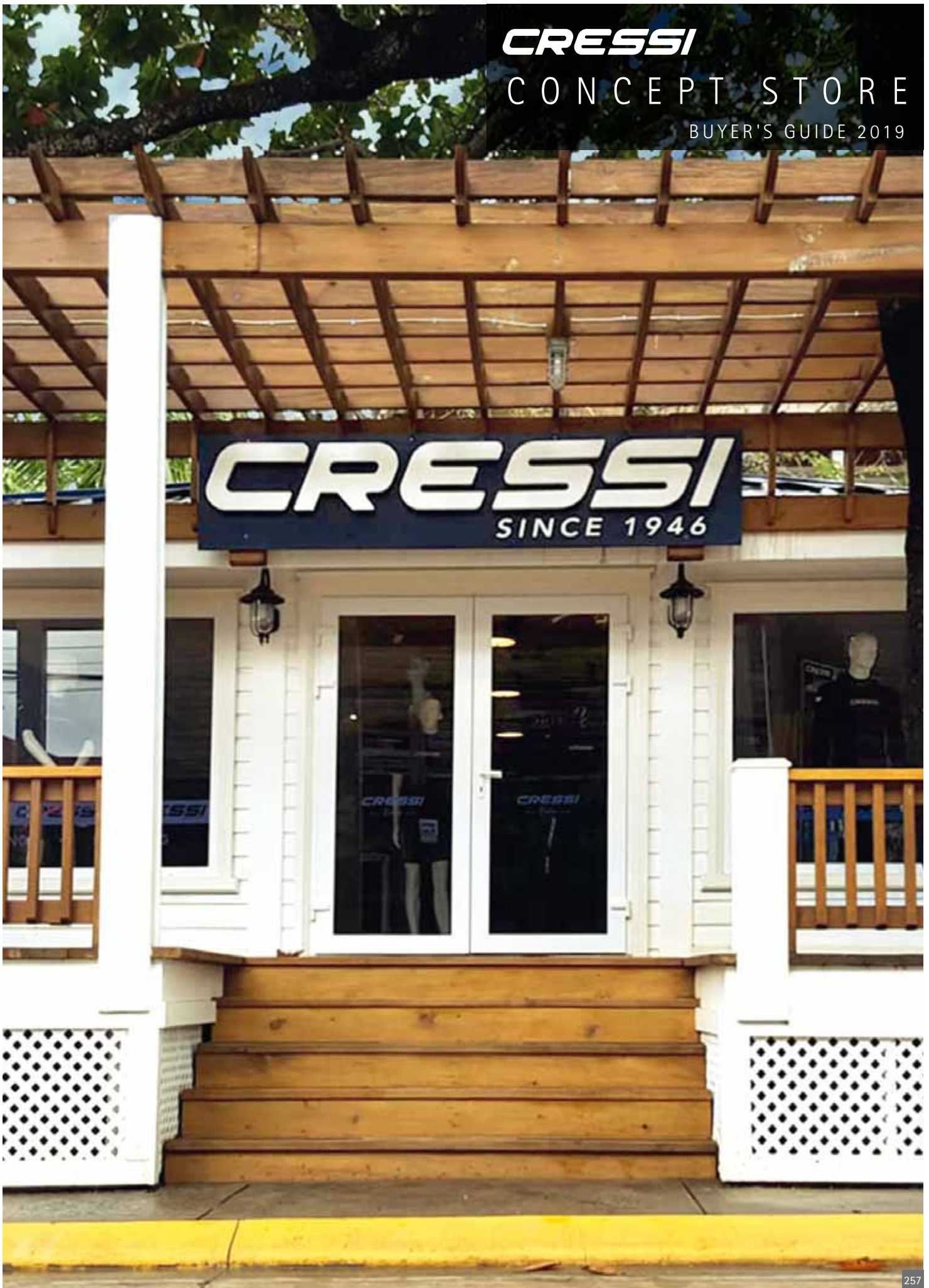

P.O.P. METAL DISPLAYS

WALL DIVE WATCH & COMPUTER METAL DISPLAY



PRODUCT	CODE
WALL DIVE WATCH & COMPUTER METAL DISPLAY	VAEUMWC

WALL REGULATOR METAL DISPLAY



PRODUCT	CODE
WALL REGULATOR METAL DISPLAY	VAEUMWR



P.O.P. ACRYLIC DISPLAYS

TABLE MASK AND SNORKEL ACRYLIC DISPLAY



PRODUCT	CODE
TABLE MASK AND SNORKEL ACRYLIC DISPLAY	VAEUAMS

TABLE DIVE WATCH & COMPUTER ACRYLIC DISPLAY



PRODUCT	CODE
TABLE DIVE WATCH & COMPUTER ACRYLIC DISPLAY	VAEUATT

WALL FLAT ACRYLIC DISPLAY



PRODUCT	CODE
WALL FLAT ACRYLIC DISPLAY	VAEFLAT

WALL MASK ACRYLIC DISPLAY



PRODUCT	CODE
WALL MASK ACRYLIC DISPLAY	VAEMASK

WALL SNORKEL ACRYLIC DISPLAY



PRODUCT	CODE
WALL SNORKEL ACRYLIC DISPLAY	VAESNOR

CRESSI OUTDOOR FLAG



WITH POLE
AND BASE



PRODUCT	CODE
CRESSI OUTDOOR FLAG	VABANOUT

BLUE FLAG



cm 100x70



cm 70x45



cm 30x20

PRODUCT	CODE
BLUE CM 100X70	VABANB01
BLUE CM 70X45	VABANB05
BLUE CM 30X20	VABANB06

DIVE CENTER FLAG



cm 100x70



cm 70x45



cm 30x20

PRODUCT	CODE
WHITE CM 100X70	VABANB11
WHITE CM 70X45	VABANB15
WHITE CM 30X20	VABANB16

SWIM AND SNORKELING DISPLAY

INCLUDES 50X HOOKS
TO DISPLAY THE PRODUCTS

SIDE A

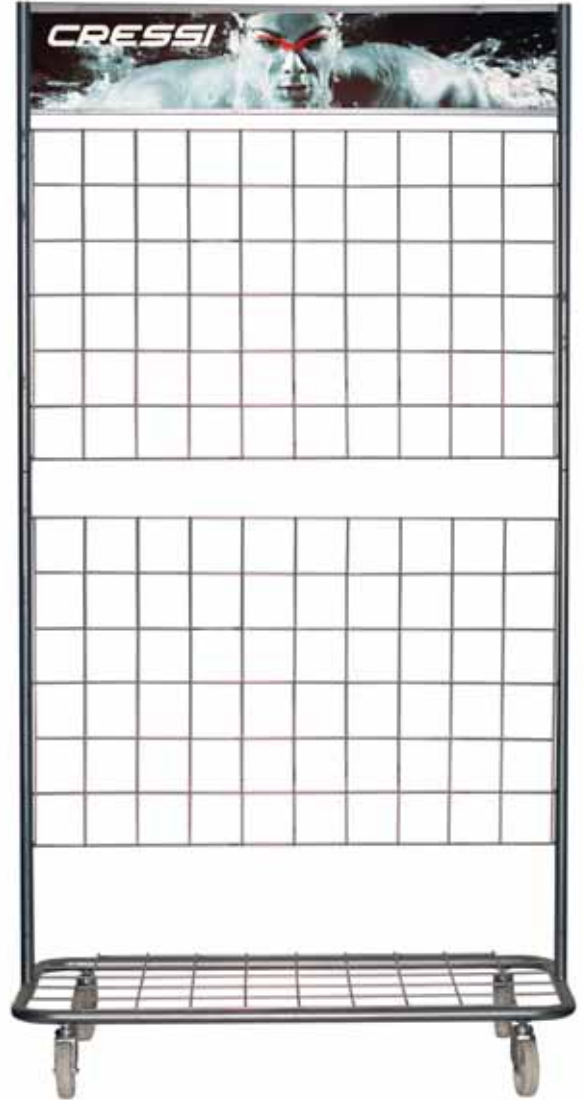

SIDE B

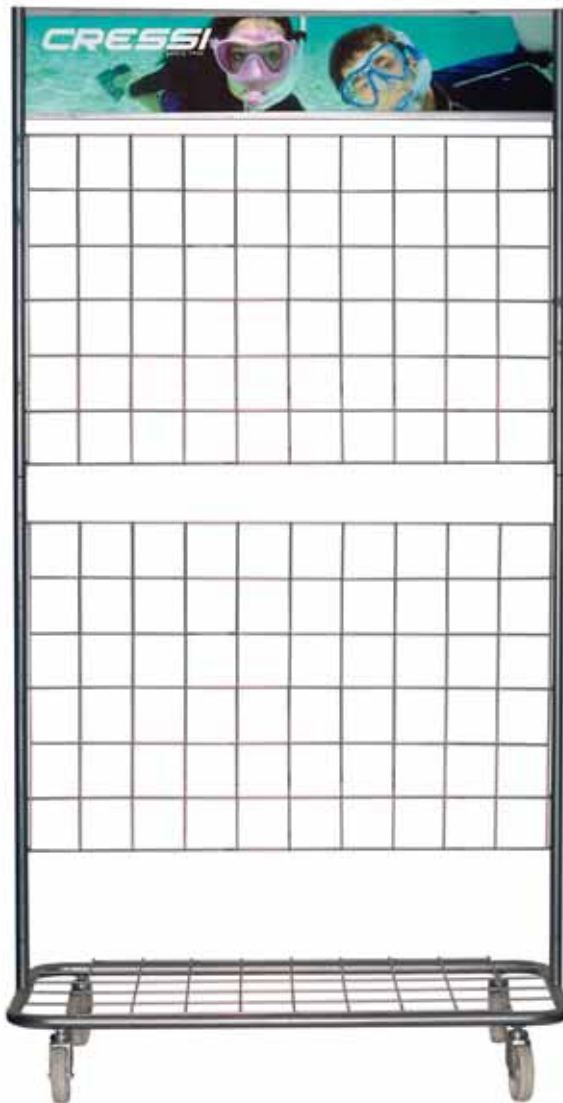

PRODUCT	CODE
SWIM & SNORKELING DISPLAY	VAESEA

GUILLAUME NÉRY

PROFESSIONAL
FREE-DIVER
WORLD CHAMPION

Guillaume Néry
-126m

TO DIVE EVER DEEPER AND ALWAYS KEEP MY ENERGY LEVELS HIGH FOR MY PROJECTS, I ENDEAVOUR TO CULTIVATE MY PERSONAL UNIVERSE, MY WORLD IN WHICH I CAN DELVE TO FIND MY NECESSARY RESOURCES AND DAILY INSPIRATION.

CRESSI

A M B A S S A D O R

BUYER'S GUIDE 2019



Guillaume Néry is a French free-diving champion, specialised in deep diving. With just one breath, he can dive to -125m below the water's surface. As a multiple world record holder and the double reigning world champion, Guillaume's goals go well beyond the simple realm of sport. With a perfect combination of aesthetics, performance, films and exploration, Guillaume practices his discipline like an art form, it has become his way of life.



SHARK & MARINE
RESEARCH
& CONSERVATION
OCEAN RAMSEY

I love companies that like to highlight important environmental issues. My most essential daily necessity: My Cressi Nano mask & my Cressi Carbon Blades.



PASSIONATE
FREE-DIVER
**FEDERICO
TRAVERSO**

He is an Italian designer and collaborates with Cressi. Passionate about the sea in all its forms, practice surfing and freediving but instead of hunting, he prefers to take pictures and videos. www.skullphoto.it
Instagram: skullphoto



PRESENTER, WRITER AND ITALIAN ENVIRONMENTALIST
TESSA GELISIO

Tessa Gelisio is a television host, author, writer and Italian environmentalist. Her love for the environment and sea, convinced her to create and take the presidency, in 2004, of the non-profit organization for Planet, which in 2009 it was officially recognized its non-profit status. The association develops conservation projects to counter the continuing deterioration of the natural ecosystems. Among her several publications, the book "The most beautiful diving in Italy" stands out for being the first tourist guide for the diver with more than 100 submarines places to visit in Italy, from Portofino to Lampedusa.





PROFESSIONAL FREE-DIVER NATIONAL RECORDS **CARLOS CORREA**

Professional Free-diver National Record
Colombian Freediver, Carlos Correa recently set a new National Record in Free Immersion (FIM) by diving to 68m in the 2014 Caribbean Cup Freediving Competition in Roatan, Honduras.



SCUBA WORLD RECORD HOLDER **LEO MORALES**

For many, scuba diving is an adventurous, recreational activity. For Cressi ambassador Leo Morales, scuba diving was therapy and the pathway to a second chance at life. After surviving a rare form of cancer, it was scuba diving that helped Leo to heal and find a deeper meaning into the purpose of his life.



CRESSI CARIBBEAN MANAGER **THEO KNEVEL**

Born in the Netherlands, Theo is an author of books on Caribbean destinations, sharing his love and passion for the islands, allowing travelers to fulfill their vacation dreams. With a Frogman career background, Theo's dive know-how allowed him to work very closely with Cressi customers on their equipment buying needs.



NATURE AND ADVENTURE PHOTOGRAPHER, BYRON BAY AUSTRALIA **CRAIG PARRY**

With challenging elements I encounter when photographing nature in the worlds oceans, Cressi keeps me safe and comfortable, allowing me to focus on capturing life in the big blue.



NEW

UNDERWATER PHOTOGRAPHER/ HAWAII **ASIA ANDERSON**

Asia loves exploring the beauty beneath the ocean's surface. Asia spends her time discovering the ocean, far and wide, over and under.



NON-PROFIT ORGANIZATION MARINE CONSERVATION **NAKAWÉ PROJECT**

Nakawe wants to thank Cressi for helping and collaborating with us to spread the global status and the importance of sharks conservation.



VIDEOGRAPHER FOR PLANETA AZUL. OCEAN CONSERVATION TV SHOW **ROBERTO OCHOA**

He started making wildlife videos at 25 years old in the Galapagos Islands, Africa and North America. Beneath the world's waters lie landscapes, species, vegetation, and populations as diverse and splendid as those on land.



SCUBA NATION TV SHOW RECREATIONAL DIVING **BILLY CATOGGIO**

We want to promote the sport to the next generation of scuba divers. Cressi is on the forefront to lead our industry into the future, and I am thrilled to be partnered with them on this journey-Scuba Nation a TV Show dedicated to recreational scuba diving.



NEW

PROFESSOR AT SIO, PROFESSIONAL PHOTOGRAPHER AND NATIONAL GEOGRAPHIC EXPLORER **OCTAVIO ABURTO**

Octavio has photographed marine ecosystems in Mexican coastal waters since 1994. His photographs have been used to illustrate outreach publications and to raise awareness about the current status of most marine ecosystems in Mexico and Latin America.



NEW

UNDERWATER PHOTOGRAPHER/ HAWAII **KRYSTAL DORN**

Krystal loves capturing the beautiful underwater world through the lens of her camera. Based out of Hawaii, Krystal loves the adventure she finds while exploring the ocean.



NEW

ADVENTURE GUIDES **CHRISTINE REGENT WEST & ADAM MAIRE**

Christine and Adam are both avid explorers with a passion for adventure and encouraging others to see the world. Their unique travels around the planet inspire others to seek out wild experiences through underwater exploration!



NEW

NATURE AND ADVENTURE PHOTOGRAPHER/ ITALY **LORENZO MITTIGA**

Born in Italy, Lorenzo is an international, award-winning nature photographer. Specializing in underwater, ocean, over-under, and landscape photography, Lorenzo works hard to display the natural world, with all its power.



NEW

UNDERWATER PHOTOGRAPHER, FREEDIVER, CONSERVATIONIST/ HAWAII **CAMERON GRANT**

At a young age, Cam discovered an overwhelming love for photography. He soon realized that he could use this powerful tool to inspire others to help protect our ocean and its marine life. Cam strives to bring attention to ocean conservation by showcasing both beauty and tragedy occurring beneath the surface.



NEW

FILMMAKER, ANIMAL EXPERT, RESEARCHER **DONALD SHULTZ**

Passionate about marine life, Donald loves adventuring underwater. Committed to learning more about misunderstood animals, Donald explores to discover and to work towards protecting the world around us.

DEALER AGREEMENT

DEALER INFORMATION

DATE

FISCAL CODE / CHAMBER OF COMMERCE NUMBER

VAT NUMBER (CEE client)

STORE

BILLING ADDRESS

SHIPPING ADDRESS (If is different from above)

TELEPHONE

N. yrs. in Business

Fax

Website

E-mail

OWNERS OR OFFICERS

1. Name

Home Phone

SS#:

Home Address

2. Name

Home Phone

SS#:

Home Address

3. Name

Home Phone

SS#:

Home Address

If Corporation, please list names of officers:

PRESIDENT:

TREASURER:

VICE PRESIDENT:

SECRETARY:

DEALER AGREEMENT

TRADE REFERENCES

1. Name _____ Tel. _____
Address _____

2. Name _____ Tel. _____
Address _____

3. Name _____ Tel. _____
Address _____

4. Name _____ Tel. _____
Address _____

The person executing this agreement has authority to bind the customer and is authorized by the customer to enter into the credit application terms and conditions.

We understand and accept the terms and conditions of {the CRESSI SUB SPA DEALER AGREEMENT} {ordering, shipping, and payment policy of CRESSI-SUB SPA}. I/We state that I/We personally guarantee payment for any and all products ordered and debts incurred with CRESSI-SUB SPA.

Signature: _____ Date: _____
Print Name: _____

Signature: _____ Date: _____
Print Name: _____

Signature: _____ Date: _____
Print Name: _____

Applicant also agrees to examine immediately upon receipt, each of Cressi's statements, and to advise Cressi of any disputed transactions or statements within 10 days of receipt, together with a written statement specifying the reason for such dispute.
Failure to notify Cressi of any dispute in respect to defective goods or billing shall constitute a waiver of all such disputes.

CREDIT CARD AUTHORIZATION FORM

I, _____, hereby authorize **CRESSI-SUB SPA** to charge my credit card account in the amount of _____ (including _____, add shipping _____).

_____ VISA _____ MasterCard _____ American Express
_____ Discover

Complete Name: _____

Credit Card Number: _____

Expiration Date: _____ Month _____ Year _____ CV# _____

Credit Card Billing Address

Street _____

City _____

State _____

Zip Code _____

Telephone Number _____

Country _____

Requested Shipping Address

Street _____

City _____

State _____

Zip Code _____

Telephone Number _____

Country _____

As the card holder, I hereby authorize receipt of merchandise at the shipping address above.

Card Holder Signature

_____/_____/_____
Date

As the credit card holder, I also authorize **CRESSI-SUB SPA** to charge my credit card for future purchases verbally approved by me. Changes to credit card information requires the completion of a new credit card authorization form.

Authorization Valid Until _____ Month _____ Year

Signature: _____

Print Name: _____

CRESSI

BUYER'S GUIDE 2019

PHOTO BY

Alberto BALBI - Rossella MURGIA - Giuseppe GODI - Roberto OCHOA - Guillaume NERY - Ocean RAMSEY - Juan OLIPHANT - Jennifer CHAVEZ and Ferrer - Candan - Chias - Clotas - Fred FALCO - Minguell - Perales - Aymerich - Selmo - Jason Arnold

© Cressi Sub S.p.A. All rights reserved. Reproduction, scanning, transmittal or storage, by any means, of the images in this catalog, whole or in part, is prohibited without the prior written permission of Cressi Sub S.p.a

INTERNATIONAL
VPBG001



CRESSI
SINCE 1946



BUYER'S GUIDE 2019

Cressi Sub S.p.A.
Via Gelasio Adamoli, 501
16165 Genova - Italy
tel +39 010 830 791
fax +39 010 830 79 220
info@cressi.com