

**20  
24** CATALOG

[www.cressi.com](http://www.cressi.com)

# CRESSI

SCUBA  
FREEDIVING  
SPEARFISHING  
iSUP  
SNORKELING  
SWIMMING

PHOTO BY: WILLIAM DRUMM





**CRESSI**

**WHO WE ARE**

B2B - Cressi University	06
Social Media	08
Our Ambassadors	09

**SCUBA**

**DIVE COMPUTERS**

Dive Computers	14
Interfaces	27

**CONSOLES**

Digital Gauges	31
Analogic Gauges	32
Dive Computer Accessories	34
Console Spare Parts	36

**REGULATORS**

First Stages & Second Stage	39
Octopuses	48
Comparison Chart	52
Regulator Accessories	55
Regulator Tools	59

**B.C.D**

Scuba B.C.D'S	61
Comparison Chart	76
Scuba Packages	79
B.C.D'S Accessories	83
B.C.D'S Tools	86

**SCUBA FINS**

Scuba Fins	88
Fins Spare Parts	112

**SCUBA MASKS**

Scuba Mask	114
Scuba Mask Accessories	142
Scuba Mask Optical Lenses	144

**SCUBA SNORKELS**

Snorkels	147
Scuba Combos	152
Snorkel Spare Parts	154

**KNIVES**

Scuba Knives	156
Clean-Up Tools	157

**SCUBA WETSUITS & NEOPRENE**

Drysuits	161
Full Wetsuits	164
Short Wetsuits	172
Skin Protections	177
Hoods	178
Gloves	180
Boots	182
Socks	186

**BAGS & BACKPACKS**

Gear Bags	190
Dry Bags	198
Net Bags	202
Equipment Bags	205

**FREEDIVING**

**FREEDIVING COMPUTERS**

Freediving Computers	208
----------------------	-----

**FREEDIVING FINS**

Long Blade Fins	211
Fin Accessories	221

**FREEDIVING MASKS & SNORKELS**

Masks	223
Combos	231
Snorkels	232

**FREEDIVING WETSUITS & NEOPRENE**

Freediving Wetsuits	235
Rash Guards	242
Gloves	244
Socks	243

**BUOYS & WEIGHTBELTS**

Buoys	245
Weight Belts	246

**FREEDIVING BAGS**

Dry Bags	248
Long Fins Bags	253

## SPEARFISHING

### SLING SPEARGUNS

Sling Spearguns	256
Shafts	266
Tips	268
Elastic Bands	269
Reels	271
Accessories	272
Bags	275

### PNEUMATIC SPEARGUNS

Pneumatic Spearguns	276
Shafts	278
Speargun Accessories	279
Comparative Chart	280
Pole Spears	282
Pole Spear Accessories	284

### TORCHES & KNIVES

Torches	287
Knives	288

## SWIMMING KIDS

Swim Masks Kids	372
Swim Goggles Kids	376
Swim Fins	381
Accessories	383

## SWIMMING ADULTS

Swim Goggles	388
Accessories	396

## STAND UP PADDLE BOARDS

iSup	402
Accessories	412
Bags & Backpacks	417
Spare parts	418

## BRAND SUPPORT

Displays	420
Flags	424
Hoodie	425
Spare Parts	426
Dimension Charts	428

## SNORKELING ADULTS

Full Face Combos	300
Sets	302
Full Face Masks	307
Combos	311
Masks	316
Snorkels	324
Fins	330
Accessories	342
Clean-up Tools	343
Mask Strap Covers	344

## SNORKELING KIDS

Full Face Masks	348
Sets	351
Combos	352
Masks	360
Snorkels	364
Fins	366
Wetsuits	368
Swimsuits	370



#	BIG EYES	138	DISPLAYS	421	FREEDIVING TRAINING BUOY	245	I		
360 REGULATOR BAG	55	BIG EYES EVOLUTION	128	DIGI2	31	FROG	94	IBIZA 3 mm	184
3 PRONGS SPEAR SPEAR	278	BIG EYES EVOLUTION CRYSTAL	124	DIVER BELOW BUOY	158	FROG PLUS	92	ICE	162
<b>A</b>		BLISS	392	DOLPHIN 2.0	373	FULL FACE MASK PARTS	308	IKARUS & ORION	314
A1	121	BLOWFISH	382	DONATELLO	22	FURY	407	INOX FINNED SHAFT Ø 6.5 mm	266
AC2 / COMPACT	45	BONETE PRO	333	DONATELLO CONSOLE 2	24	<b>G</b>		INOX NOTCHED SHAFT Ø 6 mm	266
AC2 / COMPACT + OCTOPUS COMPACT	49	BONETE PRO DRY SET	306	DONATELLO CONSOLE 3	23	GALILEO	393	INOX NOTCHED SHAFT Ø 6.5 mm	267
AC2 / XS2	46	BOOTS	183	DRY BAG	201	GARA 2000 HF	219	INOX SPEAR MONO-FLOPPER	265
AC25M / MASTER CROMO	42	BORG	156	DRY BAG PREMIUM	200	GARA 3000 LD	218	INOX THREADED SHAFT Ø 8.0 mm	267
ADAPTOR	284	BUOYS	245	DRY BOX	342	GARA PREMIUM BAG	253	INSOLE	216
AGUA	335	<b>C</b>		DRY GARA BACKPACK	252	GARA MODULAR ASSEMBLY KIT	216	INT/DIN ASSEMBLY	56
AGUA SHORT	338	CALIBRO	120	DRY GUN BAG	275	GARA MODULAR BLADES	216	INTERFACE BT	27
AIR	126	CALIBRO & CORSICA	231	DRY TEK BAG	200	GARA MODULAR BOOST	215	ISLA	183
ALLIGATOR	157	CANARIE ST / LT	186	DUKE DRY	308	GARA MODULAR FOOT POCKET	216	ISLAND 2.0	328
ALPHA ULTRA DRY	148	CARTESIO	15	<b>E</b>		GARA MODULAR IMPULSE	211	ISUP COMPARISON CHART	410
ALUMINIUM POLE	282	CHAKU	293	EAR CLIPS & NOSE PLUGS	396	GARA MODULAR IMPULSE TURBO	212	ITACA ULTRA DRY	147
AMERICA	233	CHANGING MAT	176	EBS FIN STRAP	112	GARA MODULAR SPRINT	104	<b>J</b>	
ANTI-FOGS	342	CHEROKEE EXO	260	ELEMENT	402	GARA MODULAR SPRINT TURBO	102	JUMBO	190
APACHE	165	CHEROKEE FAST	258	ELETTRA	66	GARA MODULAR TURBO BOOST	214	JUTLAND	180
APNEA	238	CHEROKEE POWER	257	ELETTRA LADY PACKAGE	80	GARA MODULAR TURBO FOOT POCKET	216	<b>K</b>	
AQUARIDE	69	CIRCULAR BAND	269	ELITE PROTECTIVE CASE	16	GARA PROFESSIONAL LD	220	KIDS SWIMSUIT	370
AQUAWING	63	CIRCULAR BAND S45	270	EMPEROR	65	GARA PROFESSIONAL SET 3.0	221	KILLER	292
AQUAWING MAX	61	CLIO	337	EQUIPMENT BAGS	205	GAUGES SPARE PARTS	36	KING	18
AQUAWING PLUS	62	COBIA	241	<b>F</b>		GENIUS DIVE CONSOLE BAG	55	KING BALOO	373
AQUAWING ACCESSORIES	83	COBRA	396	F1	316	GIANT	288	KING CRAB	375
AQUAWING DIGI PACK	79	COMANCHE RAIL	164	FAST 1 mm	171	GORGONA	204	KNIGHT	310
ATOM	223	COMBO BAG	159	FAST 3 mm	166	GORILLA PRO XL	250	KRAKEN INOX SHAFT Ø 6 mm / 6.5 mm / 7 mm	266
<b>B</b>		COMMANDER EVOLUTION	64	FAST 5 mm	165	GRINGO	233	<b>L</b>	
BABALOO DIAPER	384	COMPASS	33	F-DUAL	130	GRIP	156	LAMPUGA	236
BAGS & BACKPACKS	189	COMPETITION NYLON	272	F-DUAL & SUPERNOVA DRY	153	<b>H</b>		LEONARDO 2.0	25
BAHIA FLEX 3 mm	169	COMPUTER ACCESSORIES	34	F-DUAL & TAO DRY	152	HAKA	157	LEONARDO CONSOLE 2	26
BALEARI MD PHS 3 mm	183	CONCH DYFIBER	244	FEATHER	416	HAND PUMP	279	LIBERTY	131
BALEARI PHS 6 mm	182	CONSOLE CP2	32	FG POLE EXTENSION	284	HANDEX HOOD	179	LIBERTY DUO SPE	132
BALOO	374	CONSOLE CPD3	32	FG1 / FG2 / FG3	283	HANGERS	85	LIBERTY QUATTRO SPE	134
BAND RUBBER TUBING	269	CONSOLE PD2	32	FIN BUCKLES	112	HEX GRIP	244	LIBERTY TRISIDE SPE	133
BARON	309	CONSOLE SPARE PARTS	36	FIN PARTS	112	HIGH STRETCH	181	LIBRA	247
BARON & TONGA SET	300	CORSICA	232	FIN SOCKS	188	HIGH-TENACITY	X	LIDO JR	367
BARON JR & ROCKS SET	348	CRAB	377	FIN STRAP	112	HOLDER	X	LIDO LONG	170
BARON JUNIOR	353	CRETE	205	FINISHER	290	HOODIES	X	LIDO SHORT	175
BEANIE UNISEX	X	CRIMPING TOOL	273	FISTERRA 8 mm	235	HOSE CLIPS	85	LIGHT	339
BASE LAYER CORE VEST	178	CRIMPING TOOL SET	273	FLAGS	423	HOSE PROTECTOR	57	LINCE	137
BASE LAYER HOOD VEST	178	CRIMPS Ø 1.6 mm	274	FLASH	388	HUNTER GLOVES	244	LINE CUTTER	343
BATTERY KIT	34	CRIMPS Ø 1.8 mm	274	FLASH LADY	389	HUNTER RASH GUARD	242	LIZARD	289
BALAM	168	CRIMPS Ø 2.0 mm	274	FLOAT ROPE	245	HUNTER SOCKS	243	LONG FINS SET BAG	253
BAULA 2.5 mm	173	CRUZ	180	FLUID	405	HUNTER SWIVEL SNAP CLIP	245	LUMIA+	287
BCD ACCESSORIES	84	CUMMERBUNDS	85	FOCUS	139	HYDRA INOX SHAFT Ø 7.5 mm	266	<b>M</b>	
BCD TOOLS	86	<b>D</b>		FOX	391			MACH	276
		DESERT	161	FREE FROG	110				

MACH W/ POWER REDUCER	276	<b>N</b>		PLUMA	334	SHOCK CORD	272	TIGER SHARK	406
MAESTRALE SHAFT	278	NANO	122	PNEUMATIC SPEARGUN ACCESSORIES	278	SIGNAL BOARD BUOY	245	TINETTO & IGUANA DRY	356
MAGNETIC OCTOPUS HOLDER	57	NAXOS	116	PNEUMATIC SPEARGUN SHAFTS	278	SILICONE SCREEN PROTECTOR	209	TINETTO MINI ISLAND	358
MAINTENANCE KIT 1 <sup>ST</sup> STAGES	58	NEON	16	POLE SPEAR ACCESSORIES	284	SIMPLY MASK STRAP COVER	145	TINO & ISLAND	315
MAINTENANCE KIT 2 <sup>ND</sup> STAGES	58	NEOPRENE GOGGLE STRAP	383	POLE SPEAR POWER BAND	284	SIRENA	321	TONGA	332
MAINTENANCE KITS	86	NEPTO	19	PONY TAIL NEO	344	SIZE CHARTS	429	TOKUGAWA	239
MALPELO	196	NET BAG	159	PREDATOR	292	SKEGS	414	TOOLS	59
MAREA	318	NIKITA	275	PRESSURE GAUGE	279	SKIN	177	TORCHES	287
MAREA JR	360	NINJA FLOATING	345	PRO LIGHT	96	SKORPION	295	TORPEDO PRO BUOY FLOAT	245
MARSEILLAISE WEIGHT BELT	246	NORGE	291	PRO STAR	108	SKYLIGHT	394	TRAVEL PATROL PACKAGE	80
MASK ACCESSORIES	142	NUOTO 3.0	392	PRODUCT DISPLAY	420	SL STAR	277	TRAVELIGHT	68
MASK SPARE PARTS	143	NYLON WEIGHT BELT W/ HARD PLASTIC BUCKLE	246	PRONGS SPEAR	278	SLING SPEARGUN ACCESSORIES	266	TROPICAL	140
MATRIX	136	NYLON WEIGHT BELT W/ METAL BUCKLE	246	PUMPS	279	SLING SPEARGUNS	264	TROPICAL GLOVES 2 mm	181
MAUI	98	<b>O</b>		PURA	340	SLIP TIP	268	TROPICAL SPARE PARTS	140
MAUI SHORT	100	OCTOPUS BALANCED MG	50	PURGE BUTTONS	54	SNAKE	289	TUNA DRY	198
MAUI SPARE PARTS	100	OCTOPUS COMPACT	51	<b>Q</b>		SNORKEL SPARE PARTS	154	<b>U</b>	
MC9 / COMPACT	44	OCTOPUS COMPACT PRO	50	QUANTUM	114	SOLID	74	ULTRA STRETCH SOCKS 1.5 mm	188
MC9 / COMPACT + OCTOPUS COMPACT	48	OCTOPUS HOSE	57	QUICK-RELEASE WEIGHT BELT	246	SOLID PLUS	70	UTILA	203
MC9-SC / COMPACT PRO	43	OCTOPUS XS2	51	<b>R</b>		SOLO HOODS	179	<b>V</b>	
MED X 2.5 mm	173	OLEOPNEUMATIC REEL ADAPTER	278	RAFFAELLO	14	SPEAR GUNS	256	VICTORY	256
MED X JUNIOR	368	ONDA	320	RASH GUARDS	242	SPEARGUN BAGS	275	VIGO	296
MEGATTERA	197	ONDA & MEXICO	315	REACTION EBS	90	SPIDY	199	<b>W</b>	
METIS	227	ONDINA TOP	357	REACTION PRO	106	SPIRAL LANYARD	83	WALL DISPLAY	420
MEXICO	328	OPTICAL LENSES	144	REEF	404	STARFISH	380	WATCH PARTS	35
MICHELANGELO	20	ORCA	288	REELS	271	START	75	WEIGHT BAGS	84
MICHELANGELO CONSOLE 2	21	OUTDOOR FLAG	423	REGULATOR ACCESSORIES	55	START PRO 2.0	73	WEIGHT BELT KEEPER	247
MINI BONETE PRO DRY SET	352	<b>P</b>		REGULATOR TOOLS	58	START-ER PRO PACKAGE	81	WEIGHT BELTS	84
MINI COBRA	372	PACIFICO	140	RIGHT	390	START-ER PRO PACKAGE W/ DIGI2	81	WEIGHT POCKETS	84
MINI DRY	364	PADDLES	412	ROATAN	202	STEEL NOTCHED THREADED SHAFT Ø 7 mm	265	WETSUITS ACCESSORIES	178
MINI LIGHT	381	PALAU LAF SET	304	ROCKS	367	STICKERS	424	WISHBONE STANDARD	272
MINI SPEAR	278	PALAU SAF SET	305	ROCKS PRO DRY SET	349	STRAP EXTENDER	15	WISHBONE TYPE A	
MINI SPG	33	PALMA LT / ST	187	ROMBO	226	SUMBA XL	385	<b>X</b>	
MINICONSOLE 2	33	PARALLEL BAND Ø 16 mm	264	ROMBO & MINI DRY	354	SUPER STRETCH SWIM CAP	397	XS2	51
MINIFOG SPONGE	145	PARALYZER TIP	284	RONDINELLA	336	SUPERNOVA DRY	149	<b>Y</b>	
MINI-ISLAND	365	PARTS FOR BIG SCREEN COMPUTER	20	RUBBER FIN KEEPER	221	SUPEROCCIO	229	YUMA FAST	162
MINIMA	230	PARTS FOR WATCH-STYLE COMPUTER	35	<b>S</b>		SWIFT ADULT SWIM CAP	397	<b>Z</b>	
MINORCA LONG 3 mm	184	PATROL	72	SAFEFLEX HOSES	57	SWIM ACCESORIES	396	ZEUS	118
MINORCA SHORT 3 mm	185	PATROL SCUBA PACKAGE		SARAGO	185	SWIMSUITS	370		
MOBY 3	193	PEGASO & IGUANA DRY	355	SCILLA	327	<b>T</b>			
MOBY 5	192	PENTA+	135	SCORPION	67	T10-SC CROMO- GALAXY R	39		
MOBY 7	191	PERLA	319	SCUBA PACKAGES	79	T10-SC CROMO / MASTER CROMO	41		
MOBY LIGHT	194	PERLA JR	361	SEAHORSE	379	T10-SC PVD / MASTER BALANCED	40		
MOON	363	PIOVRA XL	251	SEPPIA 7 mm	237	TAO	151		
MOREA 3 mm	167	PIPER	195	SFI	129	TAO DRY	150		
MULTIFILAMENT	274	PIUMETTA	362	SHAFT LOADER	279	TERMICO	176		
MUSA	321	PLASTIC SCREEN PROTECTOR	34	SHAFT REFLOATER	277	THOR EBS	88		
MUSA & SCILLA	313	PLAYA FLEX 3 mm	174	SHEATH FOR KNIFE	297	THREADED FINNED SHAFT Ø 7 mm	265		



# B2B

## THE EXCLUSIVE AUTHORIZED DEALER ONLINE WEBSITE



# B2B.CRESSIUSA.COM

## WHAT IS IT?

We have developed an online order system, meaning you can now place your order at Cressi as you shop on any e-commerce website.

## HOW DOES IT WORK:

Authorized and in coordination with your Territory Sales Manager, you will receive an invitation email from [b2b@cressiusa.com](mailto:b2b@cressiusa.com)

## HOW TO ACCESS:

1. Contact your Cressi Sales Representative or the Cressi USA office and ask for your credentials.
2. Go to [b2b.cressiusa.com](http://b2b.cressiusa.com), click on dealer area, type your credentials, and log in to place your order.

## THE FEATURES:

- Enhanced experience to order easy and fast. Product Information, Technical Features, Descriptions, Photos
- Direct access at any time to Order Product
- Check-In real-time the complete Cressi Catalog Products Inventory and Immediate Availability.
- Order Management, Order History, and Shipping Information
- Backorder Management, with Accurate Estimates of Arrival Times.
- Newsletter with Deals, Specials, Outlet.

# CRESSI UNIVERSITY PLATFORM

## CRESSI LMS

(ONLINE E-LEARNING MANAGEMENT SYSTEM)

Bringing all things Cressi to you in a simple and easy to access way. The E- Learning Management system is made to educate our dealers on a wide range of topics from product, classes and certifications, all while in the comfort of your home or shop!

## [cressiuniversity.com](http://cressiuniversity.com)

REGISTER FOR FREE AND START  
LEARNING ONLINE TODAY



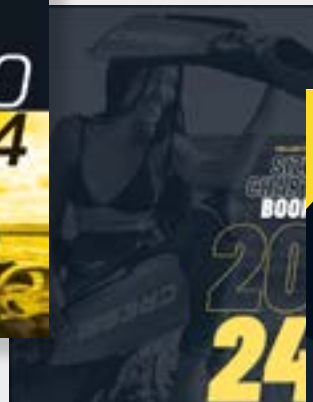

**DEALER CREDIT CARD AUTHORIZATION FORM**

NAME: \_\_\_\_\_ (LAST NAME)  
 BUSINESS ADDRESS: \_\_\_\_\_  
 CITY: \_\_\_\_\_ STATE: \_\_\_\_\_ ZIP: \_\_\_\_\_  
 CREDIT CARD TYPE:  VISA  MASTERCARD  AMERICAN EXPRESS  DISCOVER  
 CARD NUMBER: \_\_\_\_\_  
 CARD HOLDER NAME: \_\_\_\_\_  
 EXPIRATION DATE: Month \_\_\_\_\_ Year \_\_\_\_\_ CVC: \_\_\_\_\_  
 CREDIT CARD BILLING ADDRESS: \_\_\_\_\_  
 Street: \_\_\_\_\_  
 City: \_\_\_\_\_  
 ZIP Code: \_\_\_\_\_  
 Country: \_\_\_\_\_

As the credit cardholder I hereby authorize Cressi s.p.a. to charge my credit card for the amount of \_\_\_\_\_ (including any taxes and shipping charges) on my behalf.

Authorization valid until: Month \_\_\_\_\_ Year \_\_\_\_\_

CARD HOLDER SIGNATURE: \_\_\_\_\_

 **DOWNLOAD**

ALL CRESSI DOCUMENTS YOU NEED, READY ON YOUR: **CRESSI PROFESSIONAL AREA**



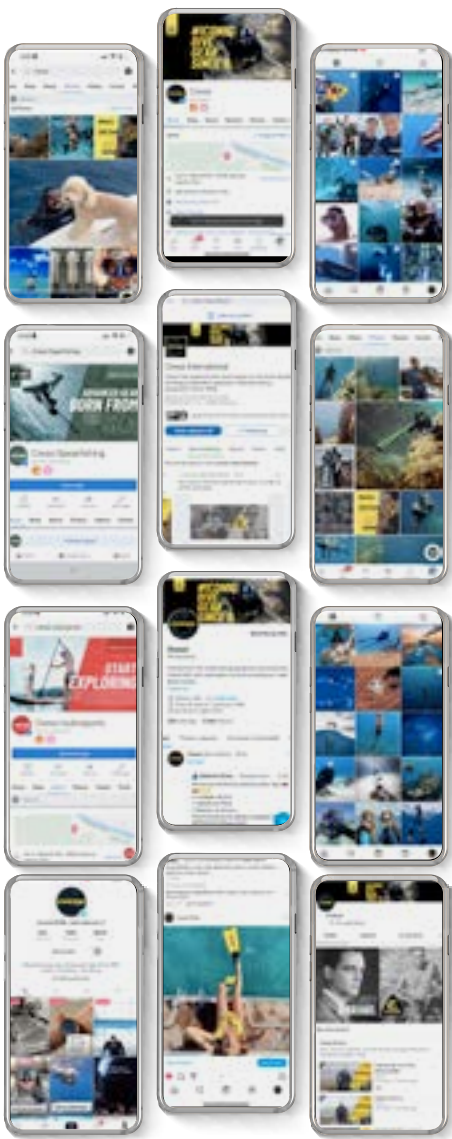

# SOCIAL MEDIA

## INTERNATIONAL ACCOUNTS

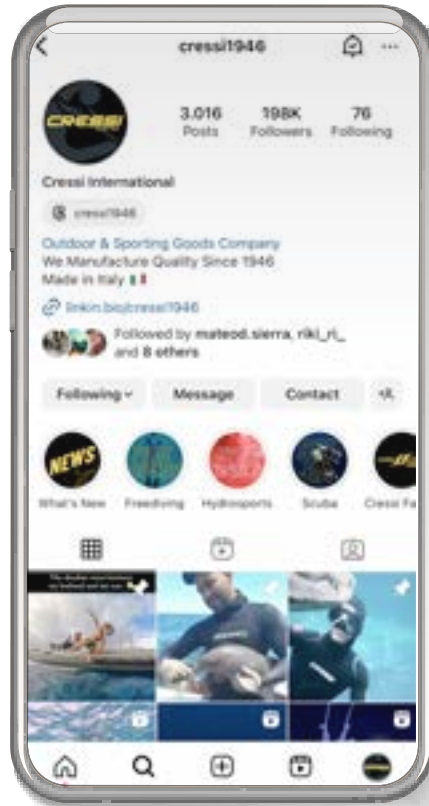

**FACEBOOK**  
OFFICIAL CRESSI PAGE

**cressigear** 232,639

OFFICIAL HYDROSPORTS PAGE

**cressi.hydrosports** 12,542

OFFICIAL SPEARFISHING PAGE

**cressi.spearfishing** 186,824



**INSTAGRAM**

OFFICIAL PAGE

**cressi1946** 184 K followers



**TIKTOK**

OFFICIAL PAGE

**@cressi1946\_international** 1,360 Followers



**LINKED-IN**

OFFICIAL PAGE

**Cressi International** 4,066K Followers



**YOUTUBE**

OFFICIAL CHANNEL

**Cressi** 10.1k Subscribers



**TWITTER**

OFFICIAL TWITTER

**cressi1946** 3,548 Followers

## 2023 SPECIAL MEDIA PROJECTS



### SHARK WEEK 2023

Shark Week is seven-day marathon documentation about sharks that airs annually on Discovery Channel since 1988. Every year it features some popular celebrities who go underwater paying a visit to the apex predator. Last week of July, Discovery Channel's Shark Week is an annual, Jaws-dropping spectacle featuring more than 30 hours of original programming about one of nature's most feared predators.

### 2023 SHOWS

- Jaws vs the Meg
- Serial Killer: Red sea feeding Frenzy
- Great Whale Fight Club
- Monsters of the Bermuda Triangle
- Mako Mania: Battle for California
- Monster Hammerheads: Killer Instinct
- Air Jaws: Final frontier
- Cocaine Sharks
- Monster Mako: Fresh Blood
- The Haunting of Shark Tower



# OUR AMBAS- SADORS

## ANDREW RAAK

USA



📷 [raakbottomimaging](#)

Passionate about all aspects of the marine environment, Andrew has worked as a dive professional for more than a decade. He has a degree in Marine Science, a captain's license and dive instructor certification. He has traveled the world photographing in amazing locations.

## ASIA BRYNNE

Hawaii



📷 [asiabrynne](#)

I picked up my first disposable film camera at the age of 8 and never stopped shooting. The ocean is a place away from all of the noise, where you don't have to use words, time doesn't exist, and you can share space with animals. Being underwater is a break from the busyness of life.

## BROOKS LAICH

USA



📷 [brookslaich](#)

He's a Canadian former professional ice hockey forward. He played over 750 National Hockey League games. Brooks is a multi-athlete and a sports lover, so what better way to kick off the day? A little snorkel session when the water is calm and fishes and turtles are active.

## CHRISTINE WEST & ADAM MAIRE

Hawaii



📷 [christine\\_regent\\_west](#)

After working as scuba instructors, adding cold-water diving was the greatest modification to their portfolio. Working together diving on a project in Alaska opened their eyes wide to documenting undersea life in extraordinarily different environments from the warm waters where they began.

## CHRISTOPHER GILLETTE

USA



📷 [gatorboys\\_chris](#)

I'm born in Florida and have spent my life around the water. I love the freedom, weightlessness, and otherworldly views of diving. I try to use my passion to teach others about aquatic wildlife in the hopes they will learn to love them too, and ultimately help protect these fragile ecosystems.

## CRAIG O'CONNELL

USA



📷 [thesharkdoctor](#)

I'm from a small town located several hours from the ocean. But I always had a fascination with the ocean, a fascination that really came to fruition during my first shark encounter in the Florida Keys when I was 14. My free diving and scuba career began and has been growing ever since.



**CRAIG PARRY**

USA



**@craigparryphotography**

It was his parent's gift of a disposable water proof camera that set him on the path to his passion. While most kids were reading comics, Craig was immersing himself in early editions of Australian Geographic. Finally the 35mm SLR set the course for Craig's future.

**FEDERICO TRAVERSO**

Italy



**@skullphoto\_aka\_surfskull**

He is a young Italian designer and collaborates with Cressi for many years. Federico is passionate about the sea in all its forms, practice surfing and freediving but instead of hunting, he prefers to take pictures and videos. He starts each day with a morning swim session in the sea.

**JACINTA SHACKLETON**

Australia



**@jacintashackleton**

Jacinta Shackleton is a marine biologist and educator at Lady Elliot Island, located right on the Great Barrier Reef. You might recognize her name from her stunning work filming and photographing marine animals. Most notably, she is 1/50 people to have seen and filmed an Ornate Eagle Ray.

**JASON WASHINGTON**

Cayman islands



**@caymanjason**

For the past two decades, Jason has been a leader in the Cayman Islands water sports community. A 2017 International Scuba Diving Hall of Fame honoree, Jason's focus both locally and abroad has been on protecting the delicate marine life found in the waters of the C. Islands.

**JONATHAN SCHUTTE**

Cayman islands



**@jonschutte**

For as long as I can remember I have had a passion for traveling and telling stories. I love to create content and share my adventures. Through my project Nauti Nomad I hope to inspire you too to embrace life and pursue your passions, respect our planet and help each other!

**KAYLEIGH & CAMERON GRANT**

Hawaii



**@mermaid.kayleigh**

Kayleigh and Cameron are passionate divers who strives to educate and encourage people to protect our oceans. As a marine conservationist, Kayleigh understands the importance of educating people about ocean conservation. Through her work at One Ocean Diving, she's able to inspire people's in protecting the world's sharks and marine life.

**KRYSTAL DORN**

USA



**@krystalklear**

Krystal moved to Hawaii, when she began photographing underwater and free diving. She is well known for capturing artistic images underwater, from mermaid photography to conservation awareness projects. Her mission is to help raise awareness for animal species.

**LEO MORALES**

Mexico



**@leomoralessbuzo**

For many, scuba diving is an adventurous, recreational activity. For Cressi ambassador Leo Morales, scuba diving was therapy and the pathway to a second chance at life. After surviving a rare form of cancer, it was scuba diving that helped Leo to heal and find a deeper meaning into the purpose of his life.

**LUCA TIXI**

Italy



**@outdoorportofino**

I was born and raised in Recco, at the time of high school, in a period of environmental militancy, the enlightenment arrives: I understand that my job will be to bring people into nature! After graduating in Marine Environmental Sciences at the University of Genoa, I founded Outdoor Portofino.

**MARIO RIGBY**

Turks&Caicos



**@mariorigby**

In 2018, Mario completed his crossing Africa journey, a two-year trek walking and kayaking from Cape Town to Cairo. This expedition allowed him to connect with communities and share their message and stories. His goal was to inspire people globally to get out, be brave, and see the world.

**NANJA VAN DEN BROEK**

Netherlands



**@nanjafreediver**

Nanja van den Broek started freediving in 2001 and in her first competition she immediately set two national records. In 2015, she set a new world record in the discipline Variable Weight with a dive to -130 meters, this record is also her 30th national record.

**NATALIE PARRA**

USA



**@natalieparra**

I'm from Southern California. I grew up playing in the ocean, but it wasn't until I was visiting the island of Oahu prior to moving there that I tried freediving for the first time. It felt like flying and I couldn't get enough of it. I started researching, taking courses and learning from fellow free divers.

**OCEAN RAMSEY & J. OLIPHANT** 



 [oceanramsey](#)

"Mr. and Mrs. Sharks." She is a marine biologist, shark and marine conservationist, professional freediver and scuba instructor, surfer, swimmer and professional model. Juan grew up surfing, he became a divemaster. He traveled the world with to help combat illegal fishing and whaling.

**PHILIP HAMILTON** 



 [philip.hamilton.photography](#)

Philip Hamilton, filmmaker, photographer and author, is best known for his passion and dedication to ocean conservation. He has over thirty years diving and sailing experience and has documented most marine animals on the planet, from the majestic Blue whale to the smallest underwater critters.

**PIRRY** 



 [pirryofficial](#)

Pirry is a Colombian journalist, writer, photographer, documentalist and important influencer that is dedicated good part of his journalist work talking about the Ocean and denouncing problems such as illegal fishing, pollution and many other difficulties facing the seas.

**PRO RECCO WATERPOLO 1913** 



 [prorecco](#)

Pro Recco Waterpolo 1913 is a water polo club from Recco and is to this day the most successful team in the world. The sea as an indissoluble link in the history, the symbiotic relationship with Liguria, the sacrifice and the constant search for innovation to win the daily challenges.

**ROBERTO OCHOA** 



 [robertochoahe](#)

Roberto Ochoa is a Videographer for Planeta Azul, he started making wildlife videos at the age of 25 in the Galapagos Islands, Africa and North America. Beneath the world's waters lie landscapes, species, vegetation, and populations as diverse and splendid as those on land.

**SHAWN MAHONEY** 



 [thebeaconscollective](#)

All of my first gear was Cressi, and most of it since has been. The early pioneers of freediving wore Cressi and I saw how successful they were so I said why not emulate what they do? I loved and still do my Cressi Gara 2000's. That's why it was a no brainer to say yea to being a Cressi ambassador.

**STEVEN PAYNE** 



 [sevenpayne](#)

Steven grew up surrounded by open spaces, farms, and lakes; he loved exploring and seeing animals. His family moved to Florida, which cemented his love for the ocean. Steven is currently in the process of deploying artificial reefs: His nonprofit, The Reef Genesis Corporation, is his passion.

**THE BUCKET LIST FAMILY** 



 [thebucketlistfamily](#)

The Gee family, just a typical family working from all over the world as Family Travel Journalists! Their story began in 2015, when they decided to sell everything and leave home for a trip around the world. They started an Instagram and YouTube channel called, The Bucket List Family.

**THEO KNEVEL** 



 [theoknevel](#)

Theo is a scuba diving and advanced free diving instructor. He joined Cressi following a 10-plus-year career as a frogman in the Special Boat Service. He has been able to spread his passion for diving throughout the Caribbean. He is co-founder and chairman of the War Veterans Foundation.

**VOYAGES OF AGAPE** 



 [voyagesofagape](#)

Agape is a 1984 Tayana Vancouver 42', hull #93. "Agape" means unconditional love. She is a true blue water cruiser, and has already seen much of Mexico, the South Pacific, and beyond. For us Agape is home. She is a safe and trustworthy vessel that will ferry us to the less seen places of the world.

An underwater photograph featuring a shark swimming in the center. To the right, a diver's fin is visible. The background is a deep blue ocean. A large, dark blue geometric shape is overlaid on the top left. A black rectangular box is centered over the shark, containing text.

## CRESSI SCUBA DIVING 2024 COLLECTION

Cressi's scuba gear is recognizable all over the world, and it is one of the centerpieces of Cressi's main product catalog. Cressi is one of only a few companies in the world that manufactures and designs a full line of scuba equipment, from dive computers, regulators, BCDs and wetsuits, mask and snorkels to fins, plus a myriad of accessories. The blues of the ocean – from a bright, vivid blue to a deep cyan blue – will be the colors used to reflect the brand personality of Cressi's Scuba line. Cyan typically represents liveliness, youth and energy, so it's the perfect color for those who share a passion for the ocean, adventure, exploration and everything scuba.





**SCUBA**



**PASSION FOR  
EXPLORATION**



# RAFFAELLO NEW 2024

## RECTANGULAR WIDE SCREEN SCUBA DIVING COMPUTER WITH COMPASS



BLACK BLUE

Raffaello is a diving computer with a durable, scratch-resistant body and a large, easy-to-read display. It offers essential dive data, including surface time and desaturation time, with a long-lasting battery and user-replaceable feature. The DIVE program utilizes the Cressi RGBM algorithm, allowing for precise dive planning and management of different air mixes. Safety features include oxygen toxicity indicators and alarms for ascent speed violations. The FREE program provides

comprehensive data for apnea diving, while the GAUGE program offers essential measurements and resettable chronometers. It features a digital compass allowing to see the cardinal directions or the degrees. It is also possible to set as zero the direction to follow avoiding drifting. The logbook can store up to 50 dives per program, and it includes a deep stage and ascent speed indicator for safe navigation. Reliability, performance, and convenience for divers.

### TECHNICAL FEATURES

- High contrast display.
  - Very large numbers, position for an easy reading.
  - Intuitive, easy access menu
  - 12/24 time and calendar
  - Back lighted display
  - Surface time, Desaturation time, no fly time
  - Low battery warning
  - Metric or imperial measures
  - Long lasting battery
  - User replaceable battery
- DIVE (AIR/NITROX) PROGRAM**
- Cressi RGBM Algorithm
  - Complete dive data elaborator
  - PPO2 1.2-1.6 setting
  - Different air mixes manageable during the dive: GAS 1 21-50% GAS 2 21-99% GAS3 21-99%
  - Graphis indicator of oxygen toxicity levels at CNS
  - Safety stop indicator
  - Safety factor can be set at different levels
  - Altitude setting
  - Uncontrolled emersion algorithm
  - Possibility to alternate Nitrox and Air dives during desaturation
  - Time visible during the dive
  - Possibility to insert/cancel a Deep stop
  - Loud alarms in case of violation of ascent speed, decompression stop or PPO2
  - Ascent alarms can be disabled
  - Total reset possible. Useful for rentals.
  - Possibility to plan dives without decompression
- FREE (APNEA) PROGRAM**
- Visualization of all diving data
  - Depth
  - Water temperature
  - Dive counter
  - Maximum depth of the dive
  - Dive time
  - Surface interval between dives
  - Duration of the diving session
  - Surface interval
  - Recovery time alarm
- GAUGE PROGRAM (without decompression calculator)**
- Depth/temperature indicator
  - Average depth
  - Dive time in minutes/seconds
  - Depth chronometer can be reset
  - Daytime visible during dive
- COMPASS**
- Cardinal directions
  - Degrees
  - Zero-degrees set direction
- OFFMODE**
- Sensors are disabled to allow snorkeling and swimming
- LOGBOOK**
- Up to 50 dives per program type



CODE	COLOR	CASE PACK
KS880052	Black/Blue	4

### OPTIONAL ACCESSORIES



CODE	PRODUCT
KZ885050	RAFFAELLO WATCHBAND - BLACK/BLUE
KS881000	INTERFACE BT FOR RAFFAELLO



PACKAGING

# CARTESIO

## SCUBA DIVING AND FREEDIVING WATCH COMPUTER



SCUBALAB  
TESTER'S  
CHOICE  
2 0 1 8



BLACK



BLACK METAL

Cartesio has a diameter of only 48 mm | 1 7/8 in and a high contrast display of 35 mm | 1 3/8 in. It is a scuba diving/apnea watch-computer of significantly reduced dimensions, it is also an ideal watch for other underwater activities, thanks to the deactivation option of the "dive" functions that avoids unnecessary alarms ringing while snorkeling or swimming. The display is made of mineral glass and the case is heavy-duty with steel buttons with an underwater resistance of up to 120 m | 328 ft. It features. Elegant metal bezel. Rubber wristband with stainless steel buckle.

CODE	COLOR	CASE PACK
K5830050	Black/Black	4
K5830850	Black/Metal	4

## OPTIONAL ACCESSORIES



### ACCESSORIES

CODE	PRODUCT
KZ810000	STRAP EXTENDER for DIVE-WATCH COMPUTER - BLACK/BLACK
K5890000	SILICONE SCREEN PROTECTOR for DIVE WATCH
K5822001	BT INTERFACE for DIVE-WATCH COMPUTER
KZ700000	ELITE PROTECTIVE CASE for DIVE COMPUTER

### SPARE PARTS

CODE	PRODUCT
KZ901000	O-RING + SCREWS FOR WATCH-STYLE COMPUTER (no battery)

## TECHNICAL FEATURES

- High contrast display with extra large numbers
- User-friendly menu
- 12/24 hours time format and calendar
- Dual-time option
- Precision stopwatch
- Alarm clock
- Backlit display
- Surf time, desaturation, and no-fly time calculator
- Choice of units in the metric or imperial system
- Low battery indicator
- User-replaceable battery; CR2450 3V

### AIR/NITROX DIVE MODE

- Cressi RGBM algorithm
- Complete diving data processor
- PPO2 1.2-1.6 BAR configuration
- It is possible to select hyper oxygenated mixes during the dive phase. GAS1 21-50% - GAS2 21-99%
- Graphic indicator of CNS toxicity level of oxygen
- Safety stop indicator
- Multiple-level safety factor configuration
- Altitude configuration
- Algorithm for managing uncontrolled ascent
- Suitable for repeated multiday decompression diving
- It is possible to alternate between nitrox and air even during desaturation
- Visualization of the current time while diving
- Deep Stop warning can be deactivated
- Alarm in case of breach of ascent speed, decompression or PPO2
- It is possible to disable the ascent alarms
- Current time visible during diving
- Possibility of eventual settings reset, useful for renting purposes
- Planning; scrolling of no-decompression limits

### FREE (APNEA) DIVE

- Display of all diving parameters, depth, temperature, dive calculator, maximum dive depth, dive time
- Length of the surface interval between each dive
- Length of diving session
- Depth, dive time, and surface interval alarms
- Recovery time alarm
- Current time visible during diving

### GAGE MODE (no decompression calculation)

- Depth/temperature indicator
- Average depth
- Dive time in minutes and seconds
- Resettable depth stopwatch
- Current time visible during diving

### OFF MODE

- Sensors disabled for snorkeling/swimming activities

### LOGBOOK

- Memory up to 50 dives per category
- Dive session history navigation

### INTERFACE

- Software with visualization of the diving sessions (sold separately)

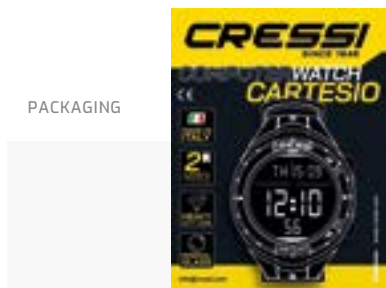

PACKAGING

# NEON

## SCUBA COMPUTER WATCH



Neon has a diameter of only 48 mm | 1 7/8 in and a high contrast display of 37 mm | 1 7/16 in. It is a scuba diving/apnea watch-computer of significantly reduced dimensions. It is also an ideal watch for other underwater activities, thanks to the deactivation option of the "dive" functions that avoids unnecessary alarms ringing while snorkeling or swimming. The display is made of mineral glass and the case is heavy-duty with steel buttons with an underwater resistance of up to 120 m. PTU rubber wristband with stainless steel buckle.



CODE	COLOR	CASE PACK
KS840020	Black/Blue	4
KS840050	Black/Grey	4
KS840055	Black/Black	4
KS840058	Black/Red	4
KS840067	Black/Green	4
KS840141	White/Lilac	4

### OPTIONAL ACCESSORIES

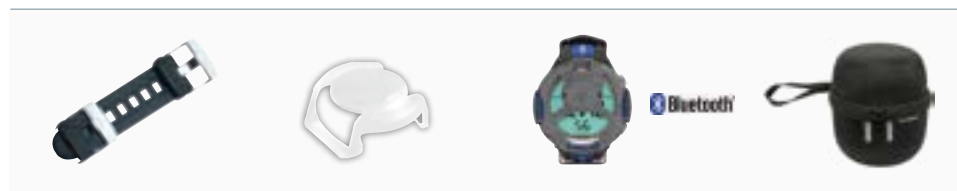

#### ACCESSORIES

CODE	PRODUCT
KZ810000	STRAP EXTENDER for DIVE-WATCH COMPUTER - Black/Black
KS890000	SILICONE SCREEN PROTECTOR for DIVE WATCH
KS822001	BT INTERFACE for DIVE-WATCH COMPUTER
KZ700000	ELITE PROTECTIVE CASE for DIVE COMPUTER

#### SPARE PARTS

CODE	PRODUCT
KZ901000	O-RING + SCREWS FOR WATCH-STYLE COMPUTER (no battery)

### TECHNICAL FEATURES

- High contrast display with extra large numbers
- User-friendly menu
- 12/24 hours time format and calendar
- Dual-time option
- Precision stopwatch
- Alarm clock
- Backlit display
- Surf time, desaturation, and no-fly time calculator
- Choice of units in the metric or imperial system
- Low battery indicator
- User-replaceable battery: CR2450 3V

#### AIR/NITROX DIVE MODE

- Cressi RGBM algorithm
- Complete diving data processor
- PPO2 1.2-1.6 BAR configuration
- It is possible to select hyper oxygenated mixes during the dive phase. GAS1 21-50% - GAS2 21-99%
- Graphic indicator of CNS toxicity level of oxygen
- Safety stop indicator
- Multiple-level safety factor configuration
- Altitude configuration
- Algorithm for managing uncontrolled ascent
- Suitable for repeated multiday decompression diving
- It is possible to alternate between nitrox and air even during desaturation
- Visualization of the current time while diving
- Deep Stop warning can be deactivated
- Alarm in case of breach of ascent speed, decompression or PPO2
- It is possible to disable the ascent alarms
- Current time visible during diving
- Possibility of eventual settings reset, useful for renting purposes
- Planning: scrolling of no-decompression limits

#### FREE (APNEA) DIVE

- Display of all diving parameters, depth, temperature, dive calculator, maximum dive depth, dive time
- Length of the surface interval between each dive
- Length of diving session
- Depth, dive time, and surface interval alarms
- Recovery time alarm
- Current time visible during diving

#### GAGE MODE (no decompression calculation)

- Depth/temperature indicator
- Average depth
- Dive time in minutes and seconds
- Resettable depth stopwatch
- Current time visible during diving

#### OFF MODE

- Sensors disabled for snorkeling/swimming activities

#### LOGBOOK

- Memory up to 50 dives per category
- Dive session history navigation

#### INTERFACE

- Software with visualization of the diving sessions (sold separately)



#### PACKAGING

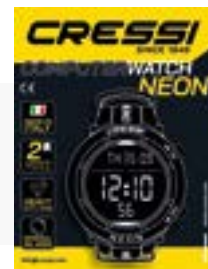



# GOA

## SCUBA COMPUTER WATCH



The Goa has a diameter of only 48 mm | 1 7/8 in and a high contrast display of 35 mm | 1 3/8 in. It is a scuba diving/apnea watch-computer of significantly reduced dimensions. It is also an ideal watch for other underwater activities, thanks to the deactivation option of the "dive" functions that avoids unnecessary alarms ringing while snorkeling or swimming. The display is made of mineral glass and the case is heavy-duty with steel buttons with an underwater resistance of up to 120m. Rubber wristband with stainless steel buckle. Plastic/steel bezel.



BLACK/GRAY    BLACK/BLUE    BLACK/WHITE    WHITE/PINK    WHITE/BLACK

CODE	COLOR	CASE PACK
K5820050	Black/Grey	4
K5820052	Black/Blue	4
K5820053	Black/White	4
K5820140	White/Pink	4
K5820150	White/Black	4

## OPTIONAL ACCESSORIES

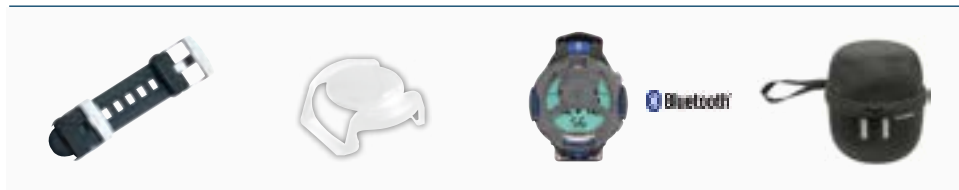

### ACCESSORIES

CODE	PRODUCT
KZ810000	STRAP EXTENDER for DIVE-WATCH COMPUTER - Black/Black
K5890000	SILICONE SCREEN PROTECTOR for DIVE WATCH
K5822001	BT INTERFACE for DIVE-WATCH COMPUTER
KZ700000	ELITE PROTECTIVE CASE for DIVE COMPUTER

### SPARE PARTS

CODE	PRODUCT
KZ901000	O-RING + SCREWS FOR WATCH-STYLE COMPUTER (no battery)

### TECHNICAL FEATURES

- High contrast display with extra large numbers
- User-friendly menu
- 12/24 hours time format and calendar
- Dual-time option
- Precision stopwatch
- Alarm clock
- Backlit display
- Surf time, desaturation, and no-fly time calculator
- Choice of units in the metric or imperial system
- Low battery indicator
- User-replaceable battery: CR2450 3V

#### AIR/NITROX DIVE MODE

- Cressi RGBM algorithm
- Complete diving data processor
- PPO2 1.2-1.6 BAR configuration
- It is possible to select hyper oxygenated mix: GAS1 21-50%
- Graphic indicator of CNS toxicity level of oxygen
- Safety stop indicator
- Multiple-level safety factor configuration
- Altitude configuration
- Algorithm for managing uncontrolled ascent
- Suitable for repeated multiday decompression diving
- It is possible to alternate between nitrox and air even during desaturation
- Visualization of the current time while diving
- Deep Stop warning can be deactivated
- Alarm in case of breach of ascent speed, decompression or PPO2
- It is possible to disable the ascent alarms
- Current time visible during diving
- Possibility of eventual settings reset, useful for renting purposes
- Planning: scrolling of no-decompression limits

#### FREE (APNEA) DIVE

- Display of all diving parameters, depth, temperature, dive calculator, maximum dive depth, dive time
- Length of the surface interval between each dive
- Length of diving session
- Depth, dive time, and surface interval alarms
- Recovery time alarm
- Current time visible during diving

#### GAGE MODE (no decompression calculation)

- Depth/temperature indicator
- Average depth
- Dive time in minutes and seconds
- Resettable depth stopwatch
- Current time visible during diving

#### OFF MODE

- Sensors disabled for snorkeling/swimming activities

#### LOGBOOK

- Memory up to 50 dives per category
- Dive session history navigation

#### INTERFACE

- Software with visualization of the diving sessions (sold separately)



### PACKAGING

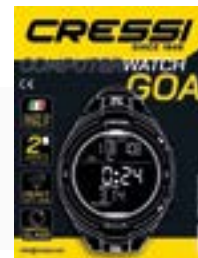



# KING

## FREEDIVING COMPUTER WATCH



King is an extremely compact watch-computer specific for freediving, for beginners to masters. This innovative product boasts an algorithm developed in Cressi, which protects the freediver from the risk of Taravana and a function that avoids the risk of pulmonary edema. Mineral glass, a heavy-duty case with steel buttons for resistance to water pressure up to 120 m / 393 ft. Elegant metal bezel in AISI 316 steel with surface treatment, and ink-filled technology for the inscription. Silicone and polyamide wristband (to prevent tears and breakage) with a stainless steel buckle.

### TECHNICAL FEATURES

- High contrast display with extra large numbers
- User-friendly menu
- 12/24 hours time format and calendar
- Dual-time option
- Precision stopwatch
- Alarm clock
- Backlit display
- Tide indicator
- Choice of units in the metric or imperial system
- Sleep mode to increase battery life
- Low battery indicator
- User-replaceable battery: CR2450 3V

#### FREE MODE

- Taravana risk reduction algorithm with 8 levels
- Pulmonary edema risk reduction function with approach dive calculation
- Display of all diving parameters
- Depth
- Temperature
- Dip counter
- Maximum dive depth
- Dive time
- Length of the surface interval between each dive
- Length of diving session
- Maximum descent and ascent speed indication
- Depth, dive time, and surface interval alarms
- Recovery time alarm
- Hydration alarm
- Alarms that can be set at the dive phase
- Fresh/salt water setting
- Lock mode for snorkeling or swimming activities

#### LOGBOOK

- Variable data logging interval
- Available during the diving session
- Visualization of the dive sessions data

#### INTERFACE

- Software with visualization of the diving sessions (sold separately)



TARAVANA PROTECTION ALGORITHM



BLOODSHIFT PROTECTION ALGORITHM



TIDE LEVEL INDICATOR



SINGLE DIP LOGBOOK



CODE	COLOR	CASE PACK
K5842020	Blue	4
K5842050	Black	4
K5842085	Orange	4

### OPTIONAL ACCESSORIES

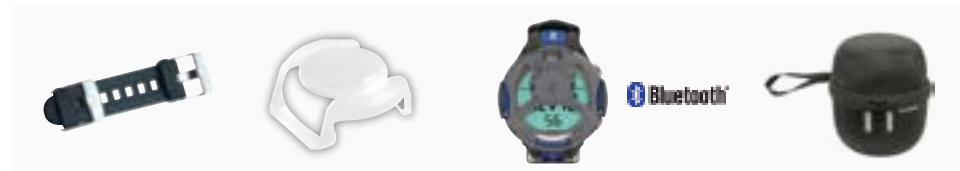

#### ACCESSORIES

CODE	PRODUCT
KZ810000	STRAP EXTENDER for DIVE-WATCH COMPUTER - Black/Black
K5890000	SILICONE SCREEN PROTECTOR for DIVE WATCH
K5822001	BT INTERFACE for DIVE-WATCH COMPUTER
KZ700000	ELITE PROTECTIVE CASE for DIVE COMPUTER

#### SPARE PARTS

CODE	PRODUCT
KZ842020	SILICONE WATCHBAND - BLUE for DIVE-WATCH COMPUTER
KZ842050	SILICONE WATCHBAND - BLACK for DIVE-WATCH COMPUTER
KZ842085	SILICONE WATCHBAND - ORANGE for DIVE-WATCH COMPUTER
KZ805099	SCREWS w/ NUT (1 pair) for DIVE WATCH COMPUTER BAND
KZ901000	O-RING + SCREWS FOR WATCH-STYLE COMPUTER (no battery)



SILICONE PROTECTIVE LENS INCLUDED

#### PACKAGING



# NEPTO

## FREEDIVING WATCH COMPUTER



Nepto is an extremely compact watch-computer specific for freediving. This innovative product boasts an algorithm developed in Cressi, which protects the freediver from the risk of Taravana and a function that avoids the risk of pulmonary edema. Mineral glass, the heavy-duty case with steel buttons for resistance to water pressure up to 120 m | 393 ft, rubber strap with stainless steel buckle.

### TECHNICAL FEATURES

- High contrast display with extra large numbers
- User-friendly menu
- 12/24 hours time format and calendar
- Dual-time option
- Precision stopwatch
- Alarm clock
- Backlit display
- Tide indicator
- Choice of units in the metric or imperial system
- Sleep mode to increase battery life
- Low battery indicator
- User-replaceable battery: CR2450 3V

#### FREE MODE

- Taravana risk reduction algorithm with 8 levels
- Pulmonary edema risk reduction function with approach dive calculation
- Display of all diving parameters
- Depth
- Temperature
- Dip counter
- Maximum dive depth
- Dive time
- Length of the surface interval between each dive
- Length of diving session
- Maximum descent and ascent speed indication
- 5-Depth, dive time, and surface interval alarms
- Recovery time alarm
- Hydration alarm
- Alarms that can be set at the dive phase
- Fresh/salt water setting
- Lock mode for snorkeling or swimming activities

#### LOGBOOK

- Variable data logging interval
- Available during the diving session
- Visualization of the dive sessions data

#### INTERFACE

- Software with visualization of the diving sessions (sold separately)

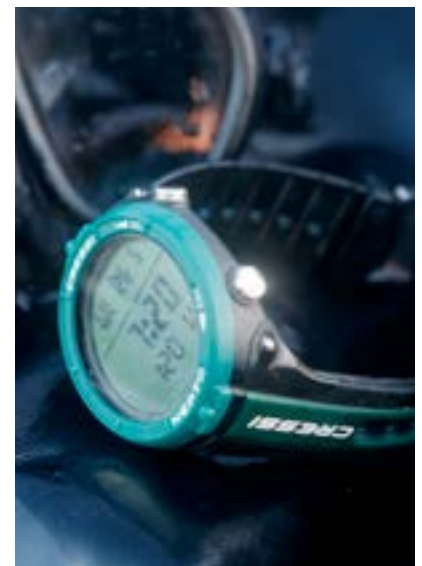

TARAVANA PROTECTION ALGORITHM



BLOODSHIFT PROTECTION ALGORITHM



TIDE LEVEL INDICATOR



SINGLE DIP LOGBOOK

CODE	COLOR	CASE PACK
K5841020	Blue	4
K5841050	Black	4
K5841098	Green	4

### OPTIONAL ACCESSORIES

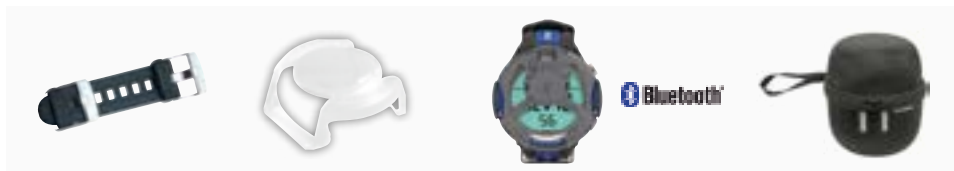

#### ACCESSORIES

CODE	PRODUCT
KZ810000	STRAP EXTENDER for DIVE-WATCH COMPUTER - Black/Black
K5890000	SILICONE SCREEN PROTECTOR for DIVE WATCH
K5822001	BT INTERFACE for DIVE-WATCH COMPUTER
KZ700000	ELITE PROTECTIVE CASE for DIVE COMPUTER

#### SPARE PARTS

CODE	PRODUCT
KZ901000	O-RING + SCREWS FOR WATCH-STYLE COMPUTER (no battery)

#### PACKAGING



# MICHELANGELO

## SCUBA DIVING AND FREEDIVING WRIST COMPUTER



### TECHNICAL FEATURES

- Structural metal bezel that enhances impact resistance
- High contrast display with extra large numbers
- User-friendly menu
- 12/24 hours time format and calendar
- Backlit display
- Surf time, desaturation, and no-fly time calculator
- Choice of units in the metric or imperial system
- Low battery indicator
- User-replaceable battery: CR2450 3V
- Replaceable plastic screen protector

#### AIR/NITROX DIVE MODE

- Cressi RGBM algorithm
- Complete diving data processor
- PPO2 1.2-1.6 BAR configuration
- It is possible to select hyper oxygenated mixes during the dive phase. GAS1 21-50% - GAS2 21-99%
- Graphic indicator of CNS toxicity level of oxygen
- Safety stop indicator
- Multiple-level safety factor configuration
- Altitude configuration
- Algorithm for managing uncontrolled ascent
- Suitable for repeated multiday decompression diving
- It is possible to alternate between nitrox and air even during desaturation
- Deep Stop warning can be deactivated
- Alarm in case of breach of ascent speed, decompression or PPO2
- It is possible to disable the ascent alarms
- Current time visible during diving
- Resettable dive settings, useful for renting operations
- Planning: scrolling of no-decompression limits
- Maximum dive depth alarm

#### FREE (APNEA) MODE

- Display of all diving parameters, depth, temperature, dip counter, maximum dive depth, dive time
- Length of the surface interval between each dive
- Length of diving session
- Depth, dive time, and surface interval alarms
- Maximum dive depth alarm
- Recovery time alarm
- Current time visible during diving

#### GAGE MODE (no decompression calculation)

- Depth/temperature indicator
- Average depth
- Dive time in minutes and seconds
- Resettable depth stopwatch
- Current time visible during diving

#### OFF MODE

- Sensors disabled for snorkeling/swimming activities

#### LOGBOOK

- Memory up to 50 dives per category
- Dive session history navigation

#### INTERFACE

- Software with visualization of the diving sessions (sold separately)

A large-screen display dive computer launched in 2020. It has been developed by the subsidiary Cressi Elettronica with the latest technology. It is a computer of completely modular construction, robust, and with a large UFDS screen that inherits the proverbial ease of navigation and menus of computers with Cressi software. The display is made of technical polyolefin and the case is heavy-duty, with a stainless steel button. Water resistant up to 150 m | 492 ft depth. TPU rubber wristband with stainless steel buckle.



CODE	COLOR	CASE PACK
K5850050	Black/Black	4



PACKAGING

### OPTIONAL ACCESSORIES



#### ACCESSORIES

CODE	PRODUCT
K5851000	BT INTERFACE for BIG-SCREEN DIVE COMPUTER
K2850098	PLASTIC SCREEN PROTECTOR for DONATELLO/MICHELANGELO
K2700000	ELITE PROTECTIVE CASE for DIVE COMPUTER

#### SPARE PARTS

CODE	PRODUCT
K2740055	WATCHBAND - BLACK for BIG-SCREEN DIVE COMPUTER
K2760525	SCREWS w/ NUT (2 pcs) for BIG-SCREEN DIVE COMPUTER
K2901001	O-RING + CAP for BIG SCREEN COMPUTER



# MICHELANGELO CONSOLE 2

COMPUTER + PRESSURE GAUGE



**Bluetooth**  
EXTERNAL BLUETOOTH  
DEVICE AVAILABLE

fluo

UNITS IN METRIC  
AND IMPERIAL  
SYSTEM

The Michelangelo Console 2 has been designed to fit the Michelangelo dive computer in a modern console, robust and easy to handle. It features an easy-to-read Pressure Gauge, that features a double scale in metric and imperial systems and a fluorescent dial, which glows in low-light conditions. The instruments are arranged on a slight tilt, which further improves the design and allows for greater readability of the same.

The use of advanced materials such as polycarbonate and Desmopan has reduced to a minimum thickness and weight, and the console reveals a surprising lightness, which translates into ease of use and minimum strain on the hose connection to the HP first stage regulator.

## TECHNICAL FEATURES

- Michelangelo 4 programs dive computer, 2 mixed gasses
- SPG global fluo in both metric and imperial systems and with fluorescent dial
- Housing in heavy-duty Desmopan material with hose clip
- HP hose
- Dimensions: 19 x 4 x 6.6 cm | 1 1/2 x 1 9/16 x 2 1/2 in
- Weight: 395 g | 13.9 oz

FLUORESCENT IS DEFINED AS EMITTING LIGHT DUE TO ABSORBING RADIATION FROM AN EXTERNAL SOURCE, OR SOMETHING VIVIDLY COLORFUL. A CFL LIGHT BULB THAT WORKS THROUGH RADIATION IS AN EXAMPLE OF A FLUORESCENT LIGHT



ELITE CASE INCLUDED

CODE	PRODUCT	CASE PACK
K5852980	MICHELANGELO CONSOLE 2 (GLOBAL FLUO)	4



## OPTIONAL ACCESSORIES

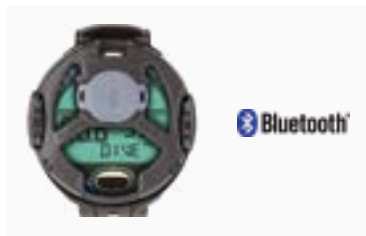

### ACCESSORIES

CODE	PRODUCT
K5851000	BT INTERFACE for BIG-SCREEN DIVE COMPUTER
K2850098	PLASTIC SCREEN PROTECTOR for DONATELLO/MICHELANGELO
K2700000	ELITE PROTECTIVE CASE for DIVE COMPUTER

### SPARE PARTS

CODE	PRODUCT
K2760525	SCREWS w/ NUT (2 pcs) for BIG-SCREEN DIVE COMPUTER
K2901001	O-RING + CAP for BIG SCREEN COMPUTER

# DONATELLO

## DIVE AIR/NITROX PROGRAM FREEDIVE WRIST COMPUTER



### TECHNICAL FEATURES

- High contrast display with extra large numbers
- User-friendly menu
- 12/24 hours time format and calendar
- Backlit display
- Surf time, desaturation, and no-fly time calculator
- Choice of units in the metric or imperial system
- Low battery indicator
- User-replaceable battery: CR2430 3V
- Replaceable plastic screen protector

#### AIR/NITROX DIVE MODE

- Cressi RGBM algorithm
- Complete diving data processor
- PPO2 1.2-1.6 BAR configuration
- It is possible to select hyper oxygenated mixes up to 50%
- Graphic indicator of CNS toxicity level of oxygen
- Safety stop indicator
- Multiple-level safety factor configuration
- Altitude configuration
- Algorithm for managing uncontrolled ascent
- Suitable for repeated multiday decompression diving
- It is possible to alternate between nitrox and air even during desaturation
- Deep Stop warning can be deactivated
- Alarm in case of breach of ascent speed, decompression or PPO2
- It is possible to disable the ascent alarms
- Current time visible during diving
- Resettable dive settings, useful for renting operations
- Planning: scrolling of no-decompression limits
- Maximum dive depth alarm

#### FREE (APNEA) MODE

- Display of all diving parameters, depth, temperature, dip counter, maximum dive depth, dive time
- Length of the surface interval between each dive
- Length of diving session
- Depth, dive time, and surface interval alarms
- Maximum dive depth alarm
- Recovery time alarm
- Current time visible during diving

#### GAGE MODE (no decompression calculation)

- Depth/temperature indicator
- Average depth
- Dive time in minutes and seconds
- Resettable depth stopwatch
- Current time visible during diving

#### OFF MODE

- Sensors disabled for snorkeling/swimming activities

#### LOGBOOK

- Memory up to 50 dives per category
- Dive session history navigation

#### INTERFACE

- Software with visualization of the diving sessions (sold separately)



BLACK/BLUE    BLACK/SILVER    BLACK/YELLOW    BLACK/PINK    BLACK/RED

It is a versatile scuba and freediving computer suitable for various water activities. Its "dive" functions can be deactivated to prevent unnecessary alarms during snorkeling or swimming. The high-contrast display is easy to read. The durable case with a steel button features a plastic bezel and protection. It's waterproof up to 150m | 492ft. The two-tone TPU rubber wristband has a stainless steel buckle. It offers complete Nitrox management, depth gauge mode, and a reset option, utilizing the

RGBM and Deep Stop algorithm. Its navigation menu system is user-friendly, with a single button for easy programming of Air, Nitrox, and Gauge modes. The high-definition screen provides large, clear numerical displays in a compact, travel-friendly design. Intuitive configuration, menu navigation, and access to a wealth of information. The "User-Friendly Display System" ensures ease of use, even in stressful situations, with a backlight that can be activated by a button or alarm.

CODE	COLOR	CASE PACK
KS860022	Black/Blue	4
KS860051	Black/Silver	4
KS860052	Black/Yellow	4
KS860054	Black/Pink	4
KS860058	Black/Red	4

### OPTIONAL ACCESSORIES



#### ACCESSORIES

CODE	PRODUCT
K5851000	BT INTERFACE for BIG-SCREEN DIVE COMPUTER
KZ850098	PLASTIC SCREEN PROTECTOR for DONATELLO/MICHELANGELO
KZ700000	ELITE PROTECTIVE CASE for DIVE COMPUTER

#### SPARE PARTS

CODE	PRODUCT
KZ740055	WATCHBAND - BLACK for BIG-SCREEN DIVE COMPUTER
KZ760525	SCREWS w/ NUT (2 pcs) for BIG-SCREEN DIVE COMPUTER
KZ901001	O-RING + CAP for BIG-SCREEN COMPUTER

#### PACKAGING

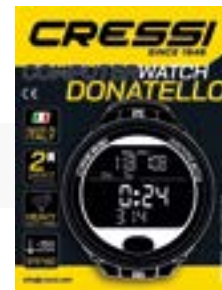

# DONATELLO CONSOLE 3

COMPUTER + PRESSURE GAUGE + COMPASS



**Bluetooth**  
EXTERNAL BLUETOOTH  
DEVICE AVAILABLE



UNITS IN METRIC  
AND IMPERIAL  
SYSTEM

The Donatello Console 3 has been designed to fit the Donatello scuba dive computer in a modern console, robust and easy to handle. It is equipped with an easy-to-read Pressure Gauge and a Compass. The SPG features a double scale in metric and imperial systems, and a fluorescent dial, which glows in low-light conditions.

The instruments are arranged on a slight tilt, which further improves the design and allows for greater

readability of the same. The use of advanced materials such as polycarbonate and Desmopan has reduced to a minimum thickness and weight, and the console reveals a surprising lightness, which translates into ease of use and minimum strain on the hose connection to the HP first stage regulator.



## TECHNICAL FEATURES

- Donatello 4 programs dive computer, 2 mixed gasses
- SPG global fluo in both metric and imperial systems and with fluorescent dial
- Compass
- Housing in heavy-duty Desmopan material with hose clip
- HP hose
- Dimensions: 19 x 6.3 x 6.6 cm 1 7/2 x 2 1/2 x 2 1/2 in
- Weight: 454 g 1 16 oz

FLUORESCENT IS DEFINED AS EMITTING LIGHT DUE TO ABSORBING RADIATION FROM AN EXTERNAL SOURCE, OR SOMETHING VIVIDLY COLORFUL. A CFL LIGHT BULB THAT WORKS THROUGH RADIATION IS AN EXAMPLE OF A FLUORESCENT LIGHT

CODE	PRODUCT	CASE PACK
K5871000	DONATELLO CONSOLE 3 (GLOBAL FLUO)	4



ELITE CASE INCLUDED

## OPTIONAL ACCESSORIES



### ACCESSORIES

CODE	PRODUCT
K5851000	BT INTERFACE for BIG-SCREEN DIVE COMPUTER
K2850098	PLASTIC SCREEN PROTECTOR for DONATELLO/MICHELANGELO
K2700000	ELITE PROTECTIVE CASE for DIVE COMPUTER

### SPARE PARTS

CODE	PRODUCT
K2760525	SCREWS w/ NUT (2 pcs) for BIG-SCREEN DIVE COMPUTER
K2901001	O-RING + CAP for BIG SCREEN COMPUTER



# DONATELLO CONSOLE 2

COMPUTER + PRESSURE GAUGE



**Bluetooth**  
EXTERNAL BLUETOOTH  
DEVICE AVAILABLE



UNITS IN METRIC  
AND IMPERIAL  
SYSTEM

The Donatello Console 2 has been designed to fit the Donatello scuba dive computer in a modern console, robust and easy to handle. It's equipped with an easy-to-read Pressure Gauge, that features a double scale in metric and imperial systems and a fluorescent dial, which glows in low-light conditions. The instruments are arranged on a slight tilt, which further improves the design and allows for greater readability of

the same. The use of advanced materials such as polycarbonate and Desmopan has reduced to a minimum thickness and weight, and the console reveals a surprising lightness, which translates into ease of use and minimum strain on the hose connection to the HP first stage regulator.

## TECHNICAL FEATURES

- Donatello 4 programs dive computer. 2 mixed gasses
- SPG global fluo in both metric and imperial systems and with fluorescent dial
- Housing in heavy-duty Desmopan material with hose clip
- HP hose
- Dimensions: 19 x 4 x 6,6 cm | 1 1/2 x 1 9/16 x 2 1/2 in
- Weight: 395 g | 13.9 oz



**FLUORESCENT IS DEFINED AS EMITTING LIGHT DUE TO ABSORBING RADIATION FROM AN EXTERNAL SOURCE, OR SOMETHING VIVIDLY COLORFUL. A CFL LIGHT BULB THAT WORKS THROUGH RADIATION IS AN EXAMPLE OF A FLUORESCENT LIGHT**

CODE	PRODUCT	CASE PACK
K5870000	DONATELLO CONSOLE 2 (GLOBAL FLUO)	4



ELITE CASE INCLUDED

## OPTIONAL ACCESSORIES

BT INTERFACE

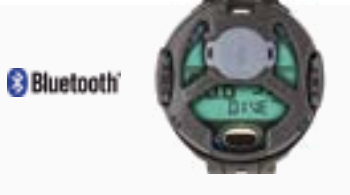

### ACCESSORIES

CODE	PRODUCT
K5851000	BT INTERFACE for BIG-SCREEN DIVE COMPUTER
KZ850098	PLASTIC SCREEN PROTECTOR for DONATELLO/MICHELANGELO
KZ700000	ELITE PROTECTIVE CASE for DIVE COMPUTER

### SPARE PARTS

CODE	PRODUCT
KZ760525	SCREWS w/ NUT (2 pcs) for BIG-SCREEN DIVE COMPUTER
KZ901001	O-RING + CAP for BIG SCREEN COMPUTER

# LEONARDO 2.0

PRODUCT UPDATE

## SCUBA DIVING WRIST COMPUTER



BLACK/BLACK



BLACK/GRAY



BLACK/PINK



BLACK/BLUE



BLACK/YELLOW



WHITE/BLACK

An elegant expression of simple, functional design, the Leonardo is a must-have for divers entering the sport and those who "just want to dive." A single-button interface makes it effortless to program Air, Nitrox, and Gauge modes the first time a diver picks the computer up, and an edge-to-edge, high-definition screen give large numerical displays in a computer that is still compact and travel-friendly. The clearly visible battery life indicator and distinct audible alarms deliver critical information as well as peace of mind during the dive. The dive settings can also be reset after each use, making it an excellent choice for rental operations.

### TECHNICAL FEATURES

- High contrast display with extra large numbers
- User-friendly menu
- 12/24 hours time format and calendar
- Backlit display
- Surf time, desaturation, and no-fly time calculator
- Choice of units in the metric or imperial system
- Low battery indicator
- User-replaceable battery: CR2430 3V
- Replaceable plastic screen protector

#### AIR/NITROX DIVE MODE

- Cressi RGBM algorithm
- Complete diving data processor
- PPO2 1.2-1.6 BAR configuration
- It is possible to select hyper oxygenated mixes up to 50%
- Graphic indicator of CNS toxicity level of oxygen
- Safety stop indicator
- Multiple-level safety factor configuration
- Altitude configuration
- Algorithm for managing uncontrolled ascent
- Suitable for repeated multiday decompression diving
- Deep Stop warning can be deactivated
- Alarm in case of breach of ascent speed, decompression or PPO2
- It is possible to disable the ascent alarms
- Resettable dive settings, useful for renting operations
- Planning: scrolling of no-decompression limits
- Maximum dive depth alarm

#### GAGE MODE (NO DECOMPRESSION CALCULATION)

- Depth/temperature indicator
- Average depth
- Dive time in minutes and seconds
- Resettable depth stopwatch

#### LOGBOOK

- Memory up to 60 dives / 75 hours
- Dive session history navigation



CODE	COLOR	CASE PACK
K5770000	Black/Black	4
K5770050	Black/Grey	4
K5770051	Black/Yellow	4
K5770052	Black/Blue	4
K5770054	Black/Pink	4
K5770150	White/Black	4

## OPTIONAL ACCESSORIES

### ACCESSORIES

CODE	PRODUCT
K5851000	BT INTERFACE for BIG-SCREEN DIVE COMPUTER
K2770098	PLASTIC SCREEN PROTECTOR for LEONARDO
K2700000	ELITE PROTECTIVE CASE for DIVE COMPUTER

### SPARE PARTS

CODE	PRODUCT
K2770020	WATCHBAND - BLACK/BLUE for BIG-SCREEN DIVE COMPUTER
K2770040	WATCHBAND - BLACK/PINK for BIG-SCREEN DIVE COMPUTER
K2770050	WATCHBAND - BLACK/BLUE for BIG-SCREEN DIVE COMPUTER
K2770051	WATCHBAND - BLACK/YELLOW for BIG-SCREEN DIVE COMPUTER
K2770150	WATCHBAND - BLACK/WHITE for BIG-SCREEN DIVE COMPUTER
K2760525	SCREWS w/ NUT (2 pcs) for BIG-SCREEN DIVE COMPUTER
K2901001	O-RING + CAP for BIG SCREEN COMPUTER

### PACKAGING



# LEONARDO 2.0 CONSOLE 2

COMPUTER + PRESSURE GAUGE



Make gauge checks fast and efficient with this two-gauge console especially crafted for the Leonardo. Polycarbonate materials and smart features make this angled console rugged, lightweight, and user-friendly. The angled console combines the Leonardo with a brass-housed, mini submersible pressure gauge that has a color-coded scale divers can read at a glance.

CODE	PRODUCT	CASE PACK
K5780050	LEONARDO CONSOLE 2 (imperial)	4

## OPTIONAL ACCESSORIES

### ACCESSORIES

CODE	PRODUCT
KZ770098	PLASTIC SCREEN PROTECTOR for LEONARDO
KZ811001	PROTECTIVE CASE for DIVE CONSOLE

### SPARE PARTS

CODE	PRODUCT
KZ760525	SCREWS w/ NUT (2 pcs) for BIG-SCREEN DIVE COMPUTER
KZ901001	O-RING + CAP for BIG SCREEN COMPUTER

## TECHNICAL FEATURES

- Polycarbonate and desmopan materials are lightweight and minimize bulk for reduced drag.
- Two connection points, one up top for a clip or bungee and wide loops on the back for connection to any strap, give divers the greatest number of mounting options.
- Angled console fits naturally in the hand and positions both the pressure gauge and computer for optimal viewing.
- Rugged pressure gauge has a chrome-plated brass case.
- Gauge dial is color-coded in red, green, and blue for instant readability.
- Reads pressures to up to 5000 PSI.
- Console is easy to assemble with each component
- Dimensions: measures 19 x 4 x 6.6 cm | 7 1/2 x 2 1/2 x 1 1/2 in.
- Weight: 394 g | 14 oz



ELITE CASE INCLUDED





# BT INTERFACE

BLUETOOTH / USB

The BT Interface is an external docking station to send data to your smartphone or to a computer through a USB connection. Thanks to it, it is possible to download the dive log and visualize the dive history with the interface software. The software allows to navigate through the performed dives and see the depth and the temperature graph as well as the parameters set and the eventual

alarms that appeared during the dive. The software for PC is downloadable from the Cressi website while the Cressi app is available on the Apple App Store and from Google Play Store. The docking station is equipped with a battery included which avoid to drain the internal battery of the dive computer.

## FOR DIVE-WATCH COMPUTER



### COMPATIBILITY



## FOR BIG-SCREEN COMPUTER



### COMPATIBILITY



## FOR RAFFAELLO NEW 2024



CODE	PRODUCT	CASE PACK
KS822001	BT INTERFACE FOR DIVE-WATCH COMPUTER	10
KS851000	BT INTERFACE FOR BIG-SCREEN COMPUTER	10
KS881000	BT INTERFACE FOR RAFFAELLO	10

### DOWNLOAD CRESSI APP AND EXPLORE YOUR DIVES ON YOUR SMARTPHONE

GET IT ON  
**CRESSI.COM**

Available on the  
**AppGallery**

Available on the  
**App Store**

GET IT ON  
**Google Play**

SCUBA - DIVE COMPUTERS - COMPARISON CHART



	RAFFAELLO	MICHELANGELO	DONATELLO	LEONARDO 2.0	CARTESIO	NEON	GOA
<b>Case diameter</b>	2 3/4 x 2 1/4 in 70 x 55 mm	2 5/8 in · 67 mm	2 5/8 in · 67 mm	2 5/8 in · 67 mm	1 7/8 in · 48 mm	1 7/8 in · 48 mm	1 7/8 in · 48 mm
<b>Display diameter</b>	2 x 1 3/8 in 51 x 35 mm	1.85 in · 47 mm	1.85 in · 47 mm	1 7/8 in · 47 mm	1 3/8 in · 35 mm	1 3/8 in · 35 mm	1 3/8 in · 35 mm
<b>Case thickness</b>	3/4 in · 18 mm	1 1/16 in · 27 mm	1 1/16 in · 27 mm	1 1/16 in · 27 mm	5/8 in · 15.8 mm	5/8 in · 15.8 mm	5/8 in · 15.8 mm
<b>Weight</b>	5.3 oz · 150 g	4.7 oz · 135 g	4.7 oz · 135 g	4.7 oz · 135 g	3.2 oz · 92 g	3.2 oz · 92 g	3.1 oz · 87 g
<b>Buttons</b>	2	1	1	1	2	2	2
<b>Backlit display</b>	Yes	Yes	Yes	Yes	Yes	Yes	Yes
<b>Dive programs</b>	Air · Nitrox · Gauge · Free · 3 Gas	Air · Nitrox · Gauge · Free · 2 Gas	Air · Nitrox · Gauge · Free	Air · Nitrox · Gauge	Air · Nitrox · Gauge · Free	Air · Nitrox · Gauge · Free	Air · Nitrox · Gauge · Free
<b>Max dive time</b>	1,032 min	1,032 min	1,032 min	255 min	1,032 min	1,032 min	1,032 min
<b>Max depth</b>	393 ft · 120 m	393 ft · 120 m	393 ft · 120 m	393 ft · 120 m	393 ft · 120 m	393 ft · 120 m	393 ft · 120 m
<b>Average depth</b>	Yes	Yes	Yes	No	Yes	Yes	Yes
<b>Depth sampling rate</b>	0.5 second	1 second	1 second	1 second	1 second	1 second	1 second
<b>Algorithm</b>	Trial-mixture Cressi-Wienke RGBM with Uncontrolled Ascent Protection Algorithm	Dual-mixture Cressi-Wienke RGBM with Uncontrolled Ascent Protection Algorithm	Cressi-Wienke RGBM with Uncontrolled Ascent Protection Algorithm	Air Nitrox Cressi-Wienke RGBM	Dual-mixture Cressi-Wienke RGBM with Uncontrolled Ascent Protection Algorithm	Dual-mixture Cressi-Wienke RGBM with Uncontrolled Ascent Protection Algorithm	Air/Nitrox Cressi-Wienke RGBM with Uncontrolled Ascent Protection Algorithm
<b>Thermometer</b>	Resolution: 1°F / 1°C Measuring field: 23°F + 104°F (-5°C + 40°C) Precision: 3.6°F (2°C) / 10 min change temp	Resolution: 1°F / 1°C Measuring field: 23°F + 104°F (-5°C + 40°C) Precision: 3.6°F (2°C) / 10 min change temp	Resolution: 1°F / 1°C Measuring field: 23°F + 104°F (-5°C + 40°C) Precision: 3.6°F (2°C) / 10 min change temp	Resolution: 1°F / 1°C Measuring field: 23°F + 104°F (-5°C + 40°C) Precision: 3.6°F (2°C) / 10 min change temp	Resolution: 1°F / 1°C Measuring field: 23°F + 104°F (-5°C + 40°C) Precision: 3.6°F (2°C) / 10 min change temp	Resolution: 1°F / 1°C Measuring field: 23°F + 104°F (-5°C + 40°C) Precision: 3.6°F (2°C) / 10 min change temp	Resolution: 1°F / 1°C Measuring field: 23°F + 104°F (-5°C + 40°C) Precision: 3.6°F (2°C) / 10 min change temp
<b>Visual and Auditory alarms</b>	Yes	Yes	Yes	Yes	Yes	Yes	Yes
<b>Ascent alarm</b>	On / Off	On / Off	On / Off	Permanent	On / Off	On / Off	On / Off
<b>Deep stop</b>	On / Off	On / Off	On / Off	On / Off	On / Off	On / Off	On / Off
<b>Tissue saturation</b>	10 saturation half-times ranging from 2.5 to 480 minutes	9 saturation half-times ranging from 2.5 to 480 minutes	9 saturation half-times ranging from 2.5 to 480 minutes	9 saturation half-times ranging from 2.5 to 480 minutes	9 saturation half-times ranging from 2.5 to 480 minutes	9 saturation half-times ranging from 2.5 to 480 minutes	9 saturation half-times ranging from 2.5 to 480 minutes
<b>PO2 parameters</b>	1.2 bar - 1.6 bar	1.2 bar - 1.6 bar	1.2 bar - 1.6 bar	1.2 bar - 1.6 bar	1.2 bar - 1.6 bar	1.2 bar - 1.6 bar	1.2 bar - 1.6 bar
<b>FO2 parameters</b>	Mix1: 21% to 50% Mix2: 21% to 99% Mix3: 21% to 99%	Mix1: 21% to 50% Mix2: 21% to 99%	Mix1: 21% to 50%	21% to 50%	Mix1: 21% to 50% Mix2: 21% to 99%	Mix1: 21% to 50% Mix2: 21% to 99%	Mix1: 21% to 50%
<b>Stopwatch during Gage mode</b>	Yes, resettable	Yes, resettable	Yes, resettable	No	Yes, resettable	Yes, resettable	Yes, resettable
<b>Clock (during the dive)</b>	Yes	Yes	Yes	No	Yes	Yes	Yes
<b>No-fly time</b>	Yes	Yes	Yes	Yes	Yes	Yes	Yes
<b>Altitude diving</b>	Yes until 12,140 ft · 3,700 m	Yes until 12,140 ft · 3,700 m	Yes until 12,140 ft · 3,700 m	Yes until 12,140 ft · 3,700 m	Yes until 12,140 ft · 3,700 m	Yes until 12,140 ft · 3,700 m	Yes until 12,140 ft · 3,700 m
<b>Log book</b>	50 dives by type	50 dives by type	50 dives by type	70 h / 60 dives	50 dives by type	50 dives by type	50 dives by type
<b>Data acquisition frequency</b>	5 second (Air-Nitrox-Gauge) 2 second (Free)	5 second (Air-Nitrox-Gauge) 2 second (Free ~60h)	5 second (Air-Nitrox-Gauge) 2 second (Free ~60h)	20 seconds	5 second (Air-Nitrox-Gauge) 2 second (Free ~60h)	5 second (Air-Nitrox-Gauge) 2 second (Free ~60h)	5 second (Air-Nitrox-Gauge) 2 second (Free ~60h)
<b>Temperature logbook acquisition</b>	Yes	Yes	Yes	No	Yes	Yes	Yes
<b>Calendar</b>	Yes	Yes	Yes	Yes	Yes	Yes	Yes
<b>Alarm clock</b>	Yes	No	No	No	Yes	Yes	Yes
<b>Secondary time</b>	Yes	No	No	No	Yes	Yes	Yes
<b>Stopwatch</b>	Yes	No	No	No	Yes	Yes	Yes
<b>Battery type</b>	CR 2450 3V	CR 2430 3V	CR 2430 3V	CR 2430 3V	CR 2450 3V	CR 2450 3V	CR 2450 3V
<b>Estimate battery life</b>	4 years	3+ years	3+ years	2 years	4 years	4 years	4 years
<b>User replaceable battery</b>	Yes	Yes	Yes	Yes	Yes	Yes	Yes
<b>Dive planner</b>	Yes	Yes	Yes	Yes	Yes	Yes	Yes
<b>User replaceable watchband</b>	Yes	Yes	Yes	Yes	Yes	Yes	Yes
<b>Watchband extension</b>	Yes	No	No	No	Yes	Yes	Yes
<b>Unit system</b>	Metric · Imperial	Metric · Imperial	Metric · Imperial	Metric · Imperial	Metric · Imperial	Metric · Imperial	Metric · Imperial
<b>Interface</b>	KS881000	KS851000	KS851000	KS851000	KS822001	KS822001	KS822001

2024 CATALOG

CRESSI



# DIVE COMPUTER COMPARISON CHART



	KING	NEPTO
<b>Case diameter</b>	1 7/8 in · 48 mm	1 7/8 in · 48 mm
<b>Display diameter</b>	1 3/8 in · 35 mm	1 3/8 in · 35 mm
<b>Case thickness</b>	5/8 in · 15.8 mm	5/8 in · 15.8 mm
<b>Weight</b>	3.2 oz · 92 g	3.2 oz · 92 g
<b>Buttons</b>	2	2
<b>Backlit display</b>	Yes	Yes
<b>Dive programs</b>	<b>Free · Lock · Sleep</b>	<b>Free · Lock · Sleep</b>
<b>Max dive time</b>	-	-
<b>Max depth</b>	393 ft · 120 m	393 ft · 120 m
<b>Average depth</b>	-	-
<b>Depth sampling rate</b>	0.5 second	0.5 second
<b>Algorithm</b>	Taravana protection algorithm Edema protection algorithm	Taravana protection algorithm Edema protection algorithm
<b>Thermometer</b>	Resolution: 1°F / 1°C Measuring field: 23°F + 104°F (-5°C + 40°C) Precision: 3.6°F (2°C) / 10 min change temp	Resolution: 1°F / 1°C Measuring field: 23°F + 104°F (-5°C + 40°C) Precision: 3.6°F (2°C) / 10 min change temp
<b>Visual and Auditory alarms</b>	Yes	Yes
<b>Alarms</b>	Surf, Depth, Dive, Step time (available during the dive) Hydratation	Surf, Depth, Dive, Step time (available during the dive) Hydratation
<b>Water salinity</b>	Fresh/Salt	Fresh/Salt
<b>Tide level indicator</b>	Yes	Yes
<b>No-fly time</b>	Yes	Yes
<b>Altitude diving</b>		
<b>Log book</b>	up to 90 dives (available during the dive)	up to 90 dives (available during the dive)
<b>Sample rate</b>	off-0.5/1/2 sec	off-0.5/1/2 sec
<b>Calendar</b>	Yes	Yes
<b>Alarm clock</b>	Yes	Yes
<b>Secondary time</b>	Yes	Yes
<b>Stopwatch + Dualtimer</b>	Yes	Yes
<b>Battery type</b>	CR 2450 3V	CR 2450 3V
<b>Estimate battery life</b>	4 years	4 years
<b>User replaceable battery</b>	Yes	Yes
<b>Sleep mode (battery safe)</b>	Yes	Yes
<b>User replaceable watchband</b>	Yes	Yes
<b>Watchband wextension</b>	Yes	Yes
<b>Unit system</b>	Metric · Imperial	Metric · Imperial
<b>INTERFACE</b>	K5822001	K5822001







# GAUGES

SCUBA



GAS PRESS 7.78 bar RANGE 34 m  
DEPTH 25.4 m DEPTH MAX 53.6 m  
31 min DIVE T

CRESSI DIGI 2

# DIGI2

## DIGITAL CONSOLE



- ### TECHNICAL FEATURES
- Automatic activation when connected to the tank
  - High contrast display
  - Depth indicator 0-120 m | 0-393 ft
  - Tank pressure indicator 0-300 BAR · 0-4,351 PSI
  - Water temperature indicator -10°C/+50°C · 14°F/122°F
  - Residual gas autonomy in minutes indicator
  - Gas reserve below 50 BAR · 725 PSI indicator
  - Maximum depth of the last dive
  - Protective display smart cover for battery saving
  - Autonomy up to 1000 hours in immersion
  - Low battery indicator
  - User-replaceable battery: CR2450 3V
  - Leak self-diagnosis for a battery change (patented)
  - User-replaceable silicone protective shell
  - Dimensions: 9.9 x 5.2 x 2.8 cm · 3.9x2x1.1 in
  - Weight: 122 g · 4.3 oz



The Digi2 is the digital response to the scuba diving must-have pressure gauge and depth gauge. Developed with the main concept to provide all the information in a compact device, showing the data in digital and large numbers. No buttons, and all the information in one screen. User-replaceable battery with leaking test. Smart cover when unused for battery saving. Impact-resistant ABS housing with thermoplastic rubber cover.



CODE	COLOR	CASE PACK
JKC800058	Red	35
KC800020	Blue	35
KC800030	White	35
KC800040	Pink	35
KC800055	Black	35



## OPTIONAL ACCESSORIES

### SPARE PARTS

CODE	PRODUCT
KZ790001	SMART COVER for DIGI2
KZ790002	REVOLVING RING DOUBLE for DIGI2
KZ790003	BATTERY KIT for DIGI2 (CR2450 3V)
KZ790020	DIGI2 COVER - BLUE
KZ790030	DIGI2 COVER - WHITE
KZ790040	DIGI2 COVER - PINK
KZ790050	DIGI2 COVER - GREY
KZ790055	DIGI2 COVER - BLACK
KZ790058	DIGI2 COVER - RED

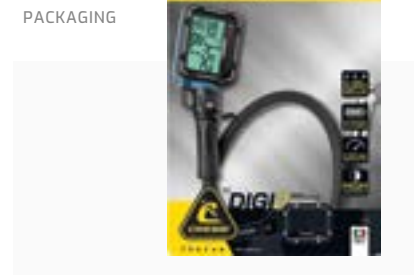

# CPD3

## COMPASS + PRESSURE GAUGE + DEPTH GAUGE

It's a very important instrument for monitoring the scuba equipment and diving safely. The Compass features a rotating bezel for easy navigation. The SPG has a color-coded scale that the divers can read at a glance. Both instruments are built with chrome-plated brass cases for maximum durability. The textured boot is easy to handle, even while wearing gloves, and can be rigged with a clip or bungee and secured to the diver's BCD for a streamlined profile in the water.



MADE IN ITALY

### TECHNICAL FEATURES

- Compass with rotating bezel for easy navigation
- SPG reads pressures until 350 BAR | 5000 PSI
- Depth Gauge reads until 70 meters | 230 feet
- Weight of the product (hose included): 456 g | 1 lb
- Compact rubber boot is textured for a sure grip
- The length of the hose is 76 cm | 30 in

CODE	PRODUCT	CASE PACK
KC764455	CONSOLE CPD3 (IMPERIAL)	4
KC764480	CONSOLE CPD3 (GLOBAL FLUO)	4

# CP2

## COMPASS + PRESSURE GAUGE

Compact and built to last, it combines a Mini SPG and a Compass. Both instruments are built with a chrome-plated brass case for maximum durability. The textured boot is easy to handle, even while wearing gloves, and can be rigged with a clip or bungee and secured to the diver's BCD for a streamlined profile in the water.



MADE IN ITALY

### TECHNICAL FEATURES

- SPG reads pressures until 350 BAR | 5000 PSI
- Pressure gauge dial is color-coded for instant readability.
- Compass with rotating bezel for easy navigation.
- Compact rubber boot is textured for a sure grip.
- Two connection loops, one on each side, for attaching a clip or bungee.
- Weight of the product (hose included): 420 g | 1 lb.

CODE	PRODUCT	CASE PACK
KC764380	CONSOLE CP2 (GLOBAL FLUO)	4
KC765350	CONSOLE CP2 (IMPERIAL)	4

# PD2

## PRESSURE GAUGE + DEPTH GAUGE

Compact and built to last, this two-gauge console combines a Mini SPG and depth gauge. The textured boot is easy to handle, even while wearing gloves, and can be rigged with a clip or bungee and secured to the diver's BCD for a streamlined profile in the water.



MADE IN ITALY

### TECHNICAL FEATURES

- Depth gauge reads to 70 m | 230 ft.
- SPG up to 350 BAR, or 5000 PSI for the imperial version.
- Pressure gauge dial is color-coded for instant readability.
- Two connection loops, one on each side, for attaching a clip or bungee
- Weight of console: 420 g - 14.8 oz

CODE	PRODUCT	CASE PACK
KC764650	CONSOLE PD2 (IMPERIAL)	4
KC764680	CONSOLE PD2 (GLOBAL FLUO)	4

### SPARE PARTS

CODE	PRODUCT
K5764109	COMPASS MODULE ONLY
KZ760601	DEPTH GAUGE MODULE (GLOBAL FLUO)
KZ764961	PRESSURE GAUGE MODULE (GLOBAL FLUO) (w/ HOSE w/o BOOT)
KZ760505	DEPTH GAUGE MODULE (IMPERIAL)
KZ801010	PRESSURE GAUGE MODULE (PSI) (w/ HOSE w/o BOOT)



# MINICONSOLE 2

## IMPERIAL - GLOBAL FLUO

Compact and built to last, this two-gauge console combines an SPG and depth gauge. The textured boot is easy to handle, even while wearing gloves, and can be rigged with a clip or bungee and secured to the diver's BCD for a streamlined profile in the water.



MADE IN ITALY

CODE	PRODUCT	CASE PACK
KC766255	MINICONSOLE 2 (GLOBAL FLUO)	4
KC765250	MINICONSOLE 2 (IMPERIAL)	4

### SPARE PARTS

CODE	PRODUCT
KZ760601	DEPTH GAUGE MODULE (GLOBAL FLUO)
KZ764961	PRESSURE GAUGE MODULE (GLOBAL FLUO) [w/ HOSE w/o BOOT]
KZ760505	DEPTH GAUGE MODULE (IMPERIAL)
KZ801010	PRESSURE GAUGE MODULE (PSI) [w/ HOSE w/o BOOT]

### TECHNICAL FEATURES

- Pressure gauge dial is color-coded in for instant readability.
- Reads pressures to 350 BAR · 5000 PSI.
- Depth gauge reads up to 70 m · 230 ft.
- Maximum depth indicator.
- The global fluo version features a dual system on a luminescent dial that increases readability underwater.

**Fluorescent** is defined as emitting light due to absorbing radiation from an external source, or something vividly colorful. A CFL light bulb that works through radiation is an example of a fluorescent light

# MINI SPG

## PRESSURE GAUGE - GLOBAL FLUO

Compact and built to last, the console includes and protects a mini SPG. The shell is made of rubber, increasing grip and resistance to bumps.



MADE IN ITALY

CODE	PRODUCT	STYLE	CASE PACK
KK760510	MINI SPG (GLOBAL FLUO)	Global Fluo	4
KK760400	MINI SPG (PSI)	Imperial	4

### SPARE PARTS

CODE	PRODUCT
KZ801010	PRESSURE GAUGE MODULE (PSI) [w/ HOSE w/o BOOT]
KZ764961	PRESSURE GAUGE MODULE (GLOBAL FLUO) [w/ HOSE w/o BOOT]

### TECHNICAL FEATURES

- Pressure gauge dial is color-coded for instant readability.
- Reads pressures to 350 BAR · 5000 PSI.
- Maximum depth indicator.
- Connection loop up-top is perfect for attaching a clip or bungee.
- The global fluo version features a dual system on a luminescent dial that increases readability underwater.

**Fluorescent** is defined as emitting light due to absorbing radiation from an external source, or something vividly colorful. A CFL light bulb that works through radiation is an example of a fluorescent light

# COMPASS



WITH STRAP AND HOSE MOUNT



MODULE

CODE	PRODUCT	CASE PACK
KB760100	COMPASS w/ STRAP AND HOSE MOUNT	10
KS764109	COMPASS MODULE ONLY	5

### TECHNICAL FEATURES

- Top and side reading
- Luminescent gauge face
- Highly accurate
- With strap and bcd holder

## PLASTIC SCREEN PROTECTOR



CODE	PRODUCT
KZ740098	GIOTTO
KZ770098	LEONARDO
KZ850098	DONATELLO/MICHELANGELO

DESCRIPTION: The screen protector eliminates almost completely the effects of abrasion and shocks while making for perfect visibility.

## BIG-SCREEN DIVE COMPUTER WATCHBAND



CODE	PRODUCT
KZ850097	WATCHBAND BLACK/BLACK/GREY
KZ740055	WATCHBAND BLACK/BLACK/GREY
KZ770020	WATCHBAND BLACK/BLUE
KZ770040	WATCHBAND BLACK/PINK
KZ770050	WATCHBAND BLACK/GREY
KZ770051	WATCHBAND BLACK/YELLOW
KZ770150	WATCHBAND BLACK/WHITE
KZ885050	WATCHBAND BLACK/BLUE

## BATTERY COVER KIT



CODE	PRODUCT
KZ901001	O-RING + CAP for BIG SCREEN COMPUTER

DESCRIPTION: Replacement spare part kits for big screen dive computers

## WATCHBAND / CONSOLE SCREWS



CODE	PRODUCT
KZ760525	SCREWS w/ NUT (2 pcs) for BIG-DISPLAY DIVE COMPUTER

DESCRIPTION: Stainless steel screw + nut for big screen dive computers

COMPATIBILITY:  
Giotto computer  
Leonardo computer  
Donatello computer  
Michelangelo computer  
Console computer



## SILICONE SCREEN PROTECTOR

MAGNIFYING EFFECT  
+15% LARGER DISPLAY  
NUMBERS



CODE	PRODUCT
K5890000	SILICONE SCREEN PROTECTOR for DIVE WATCH

DESCRIPTION: The screen protector eliminates almost completely the effects of abrasion and shocks on both the display and the sides of the bezel, while making for perfect visibility. Thanks to this protection, the dive computer retains its pleasing, undamaged appearance even after prolonged, intensive underwater use.

COMPATIBILITY:  
Cartesio, Neon, Goa, Nepto, King

## WATCHBAND EXTENDER

ADDITIONAL LENGTH  
+4 INCH / 10 CM



CODE	PRODUCT
KZ810000	STRAP EXTENDER for DIVE-WATCH COMPUTER BLACK/BLACK

DESCRIPTION: Designed to wear the dive watch computer over a thick wetsuit. Made with the same high-quality rubber and corrosion-resistant materials as the original straps. Easily clasps on the buckle end of the computer's strap increasing its length.

COMPATIBILITY:  
Cartesio, Neon, Goa, Nepto, King

## WATCH-STYLE COMPUTER O-RING KIT



O - RING + SCREWS

CODE	PRODUCT
KZ901000	O-RING + SCREWS for WATCH-STYLE COMPUTER
KZ900001	CALIBRATED SCREWDRIVER

DESCRIPTION: Replacement spare part kits for computer watches

COMPATIBILITY:  
Cartesio, Neon, Goa, Nepto, King

## WATCH-STYLE DIVE COMPUTER WATCHBAND



CODE	PRODUCT
KZ820050	WATCHBAND BLACK/BLACK/GREY
KZ820052	WATCHBAND BLACK/BLACKBLUE
KZ820053	WATCHBAND BLACK/BLACK/WHITE
KZ820140	WATCHBAND WHITE/WHITE/PINK
KZ820150	WATCHBAND WHITE/WHITE/BLACK
KZ8230050	WATCHBAND BLACK/BLACK/BLACK
KZ840020	WATCHBAND BLACK/BLACK/BLUE
KZ840050	WATCHBAND BLACK/GREY/WHITE
KZ840058	WATCHBAND BLACK/RED/WHITE
KZ840067	WATCHBAND BLACK/LIME/WHITE
KZ840085	WATCHBAND BLACK/ORANGE/WHITE
KZ840141	WATCHBAND WHITE/LILAC/WHITE
KZ841098	WATCHBAND BLACK/GREEN/WHITE
KZ842020	SILICONE WATCHBAND BLUE
KZ842050	SILICONE WATCHBAND BLACK
KZ842085	SILICONE WATCHBAND ORANGE

## WATCH-STYLE COMPUTER WATCHBAND SCREWS



CODE	PRODUCT
KZ805099	SCREWS w/ NUT (1 pair) for WATCH-STYLE DIVE COMPUTER WATCHBAND

DESCRIPTION: Stainless steel screws for watch-style dive computer watchbands. Sold by pair.

COMPATIBILITY:  
Cartesio, Neon, Goa, Nepto, King

### WATCH SPARE PARTS

CODE	PRODUCT
KZ764700	WATCHSTRAP - BLACK for MANTA
KZ764755	WATCHSTRAP - BLACK/BLACK for MANTA
KZ764788	WATCHSTRAP - RED for MANTA



# CONSOLE SPARE PARTS

## DIGI2 SMART COVER



CODE
KZ790001

DESCRIPTION: Smart display cover for DIGI2 console.  
SUITABLE FOR: DIGI2 Console

## DIGI2 COVERS



CODE	COLOR
KZ790020	BLUE
KZ790030	WHITE
KZ790040	PINK
KZ790050	GREY
KZ790055	BLACK
KZ790058	RED

## BATTERY KIT FOR DIGI2 (CR2450 3V)



CODE
KZ790003

DESCRIPTION: Replacement battery CR2450 + O-Ring and rear cap kit.  
SUITABLE FOR: DIGI2 Console, DIGI Console

## PRESSURE GAUGE MODULE W/ HOSE

MADE IN ITALY



CODE	STYLE
KZ764961	Global Fluo
KZ801010	Imperial

DESCRIPTION: Mini SPG + hose without rubber boot.

## PRESSURE GAUGE MODULE W/O HOSE

MADE IN ITALY



CODE	STYLE
KZ760400	Imperial
KZ760300	Metric
KZ760600	Global Fluo

DESCRIPTION: Mini SPG module without boot and hose.

## DEPTH GAUGE MODULE

MADE IN ITALY



CODE	PRODUCT
KZ760505	Imperial
KZ760601	Global Fluo

DESCRIPTION: Mini-depth gauge module for console.  
SUITABLE FOR: PD2 Console, CPD3 Console, Computer Console 2

## COMPASS MODULE



CODE
K5764109

DESCRIPTION: Spare compass module for console.  
SUITABLE FOR: CP2 Console, CPD3 Console, Computer Console 3

## GAUGE HOSE



CODE	PRODUCT
KZ760501	HOSE
KZ760503	SWIVEL

DESCRIPTION: HP hose for pressure gauge. length: 81 cm / 32 inch. Swivel replacement with o-ring for High Pressure hoses.

## HOUSING FOR CONSOLE

**HOUSING FOR CONSOLE  
COMPUTER 2 / CP2 / PD2 - PART A**



CODE

KZ764900

**HOUSING FOR CONSOLE  
COMPUTER 2 / PD2 - PART B**



CODE

KZ764910

**HOUSING FOR CONSOLE  
CP2 - PART B**



CODE

KZ764915

**HOUSING FOR CONSOLE  
COMPUTER 3 / CPD3 - PART A**



CODE

KZ764920

**HOUSING FOR CONSOLE  
CPD3 / PD2 - ADAPTER**



CODE

KZ764930

**HOUSING FOR CONSOLE  
COMPUTER 3 / CPD3 - PART C**



CODE

KZ770190

**SCREWS  
W/ NUT FOR  
COMPUTER  
AND CONSOLE**



1 PAIR

CODE

KZ760525

**CONSOLE HOUSING ASSEMBLING CHART**  
CONSOLE SPARE PARTS

CONSOLE NAME	PART A	PART B	PART C	ADAPTER	SCREWS / NUT
CONSOLE COMPUTER 2	KZ764900	KZ764910			KZ760525
CONSOLE COMPUTER 3	KZ764920		KZ770190		KZ760525
CPD3 - COMPASS + PRESSURE GAUGE + DEPTH GAUGE	KZ764920		KZ770190	KZ764930	KZ760525
PD2 - PRESSURE GAUGE + DEPTH GAUGE	KZ764900	KZ764910		KZ764930	KZ760525
CP2 - COMPASS + PRESSURE GAUGE	KZ764900	KZ764910			KZ760525

## MINICONSOLE 2



CODE

KZ764096

## MINI SPG



CODE

KZ760519



**REGULATORS**  
SCUBA





1<sup>ST</sup> STAGE

# T10-SC CROMO

2<sup>ND</sup> STAGE

# GALAXY-R

**TOTAL WEIGHT**

T10-SC/GALAXY-R INT HOSE INCLUDED: 1.055 G | 2 LB 5 OZ

T10-SC/GALAXY-R DIN HOSE INCLUDED: 937 G | 2 LB 1 OZ



Very high-performance regulator, engineered in Italy with the best technology available. Ideal for seasoned or professional divers who need extremely high performing equipment that is both simple and resistant, without any of the usual accessories that may get damaged. The T10-SC features a watertight chamber designed for cold water use. Chrome finishing. The Galaxy-R features the adjustable inhalation effort knob on the left side.



T10-SC CROMO  
INT VERSION



T10-SC CROMO  
DIN VERSION

**TECHNICAL FEATURES**

**1<sup>ST</sup> STAGE**

- Hyperbalanced diaphragm
- 2 HP 7/16 UNF ports
- 4 MP 3/8 UNF ports
- Operating pressure:
  - INT version: 230 BAR | 3.336 PSI
  - DIN Version: 300 BAR | 4.351 PSI
- Calibration pressure: 10 BAR | 146 PSI
- High-capacity conical filter in chemical nickel-plated spherical bronze
- Removable nozzle in AISI 316 steel
- Hyperbalancing system
- Anti-pressure drop pneumatic spring
- Stainless steel calibration spring with micropeening treatment
- Low-friction technopolymer slider shaft
- Quantity of air supplied: 4500 l/min | 159 cu ft/min

**2<sup>ND</sup> STAGE**

- Pneumatically balanced
- Adjustable Venturi
- Adjustable inhalation effort
- Patented elliptical diaphragm
- Patented low-friction lever
- Air delivery system without injector
- Adjuster knob coated with dual OR
- Internal heat exchanger
- Cap opening with Cam-lock
- Noise-absorbing technopolymer body
- Removable technopolymer deflector
- Removable mechanics

**COMBINATION PERFORMANCE**

- Average cracking effort: 3.5 mBAR | 1.41 in wc
- Average breathing effort: 0.6 J/l



CODE	PRODUCT	STYLE	CASE PACK
HX890000	T10-SC CROMO/GALAXY ADJ [INT]	INT	1
HX890100	T10-SC CROMO/GALAXY ADJ [DIN]	DIN	1

**SPARE PARTS**

CODE	PRODUCT
HZ800045	MAINTENANCE KIT for T10/T10-SC INT/DIN
HZ820080	MAINTENANCE KIT for MASTER/GALAXY/ELLIPSE BALANCED
HZ830035	DIN ASSEMBLY for T10/T10-SC



**Certification EN250/2014 for cold water.**  
The T10-SEAL CHAMBER 1<sup>ST</sup> stage is environmentally sealed, protecting it against icing in cold water and against contamination from particulate matter in silty conditions.

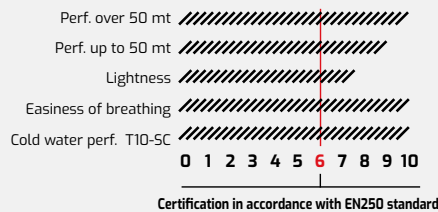
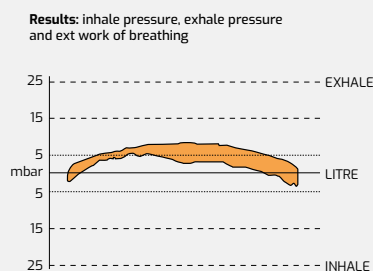

1<sup>ST</sup> STAGE

2<sup>ND</sup> STAGE

# T10-SC PVD MASTER BALANCED

TOTAL WEIGHT

INT VERSION HOSE INCLUDED: 1.080 G | 2 LB 6 OZ

DIN VERSION HOSE INCLUDED: 962 G | 2 LB 2 OZ



This regulator is a top choice for diving professionals, offering excellent performance, ergonomic design, and easy maintenance. Instructors, guides, dive operators, and researchers will appreciate its versatility. What sets it apart is the unique first stage design, featuring a perpendicular "T" configuration that enhances compactness and lightness. This design seamlessly integrates with the valve profile, providing divers with greater head movement freedom. It also optimizes hose placement, minimizes space usage (especially in cold-water SC versions), and simplifies inspection and maintenance. The regulator boasts a larger, high-efficiency conical filter, easily accessible valves on the tank, and a robust metal body protected by a durable PVD coating, making it highly resistant to wear and tear from dives. When combined with the Master Cromo 2nd stage, equipped with an internal

heat exchanger, this regulator stands out as the ideal option for divers venturing into the harshest cold-water conditions. Its sleek satin chrome finish not only adds durability but also aesthetic appeal. It incorporates a pneumatic compensation mechanism that ensures a consistently smooth and exceptional airflow, delivering precisely calibrated air without relying on an exaggerated Venturi effect. For added convenience, the knob includes a nut for fine-tuning the breathing effort, allowing divers to customize their experience to perfection.

T10-SC PVD INT VERSION

T10-SC PVD DIN VERSION

## TECHNICAL FEATURES

- 1<sup>ST</sup> STAGE**
- Hyperbalanced diaphragm (Watertight chamber on T10-SC)
  - 2 7/16" HP ports UNF
  - 4 3/8" LP ports UNF
  - Operating pressure:
    - INT version: 230 BAR | 3.336 PSI
    - DIN version: 300 BAR | 4.351 PSI
  - Calibration pressure: 10 BAR | 146 PSI
  - Body coated with PVD process
  - High-capacity conical filter in chemical nickel-plated spherical bronze
  - Removable nozzle in AISI 316 steel
  - Hyperbalancing system
  - Anti-pressure drop pneumatic spring
  - Stainless steel calibration spring with micropeening treatment
  - Low-friction technopolymer slider shaft
  - Quantity of air supplied: 4,500 l/min 159 cu ft/min

- 2<sup>ND</sup> STAGE**
- Adjustable pneumatical balanced
  - Adjustable Venturi
  - Adjustable inhalation effort
  - Patented elliptical diaphragm
  - Patented low-friction lever
  - Air delivery system without injector
  - Adjuster knob coated with PVD process with dual OR Laser-etched titanium front piece
  - Internal heat exchanger
  - Cap opening with cam-lock
  - Noise-absorbing technopolymer body
  - Removable technopolymer deflector
  - Removable mechanics

- COMBINATION PERFORMANCE**
- Average cracking effort: 1.41 in wc | 3.5 mBAR
  - Average breathing effort: 0.6 J/l

**CERTIFICATION:** EN250/2014 FOR COLD WATER



CODE	PRODUCT	STYLE	CASE PACK
HX830000	T10-SC PVD / MASTER (INT)	INT	1
HX830100	T10-SC PVD / MASTER (DIN 300)	DIN	1

SPARE PARTS

CODE	PRODUCT
HZ800045	MAINTENANCE KIT for T10/T10-SC INT/DIN
HZ820080	MAINTENANCE KIT for MASTER/GALAXY/ELLIPSE BALANCED
HZ830035	DIN ASSEMBLY for T10/T10-SC
HZ730230	LP HOSE SAFEFLEX (black) (78 cm   30.7 in)

 **COLD WATERS CERTIFIED**

Certification EN250/2014 for cold water.

The T10-SEAL CHAMBER 1ST stage is environmentally sealed, protecting it against icing in cold water and against contamination from particulate matter in silty conditions.

 **PVD COATING**

PVD is an environmentally friendly process that provides brilliant and durable decorative finishes. Benefits: PVD offers top-notch finishes that provide a superior look to the material. Pvd is uv resistant and chemical resistant.

**RESULTS: INHALE PRESSURE, EXHALE PRESSURE AND EXT WORK OF BREATHING**

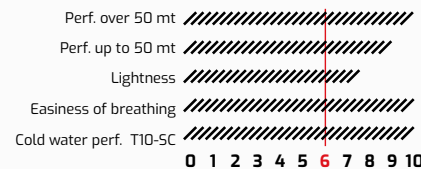
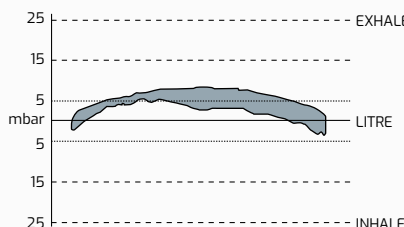

Certification in accordance with EN250 standard

1<sup>ST</sup> STAGE

2<sup>ND</sup> STAGE

# T10-SC CROMO MASTER CROMO

TOTAL WEIGHT

INT VERSION HOSE INCLUDED: 1.080 G | 2 LB 6 OZ

DIN VERSION HOSE INCLUDED: 962 G | 2 LB 2 OZ



The T10-SC/Master Cromo is an all-around scuba diving regulator ideal to be used in any condition. It is compact, light, and reliable and it will accompany you throughout your life on any trip. The T10-SC 1st stage is environmentally sealed, protecting it against icing in cold water and against contamination from particulate matter in silty conditions. The T configuration enables better integration of the first stage in the profile of the valve, and thus greater freedom of movement of the diver's head. The mechanism works transversally, supplying air and filtering potential particulates coming from the tank that manages to pass through the filter so that they do not directly affect the valve. When paired with the Master Cromo 2nd stage, which includes an internal



T10-SC INT VERSION

T10-SC DIN VERSION

heat exchanger, this regulator is an excellent choice for divers exploring the most extreme cold water environments. It features a pleasing and durable satin chrome finish. Pneumatic compensation mechanism to guarantee smooth exceptional flow and abundant calibrated air delivery with no need for an accentuated Venturi effect. The knob includes a nut for fine-tuning the breathing effort.

### TECHNICAL FEATURES

**1<sup>ST</sup> STAGE**

- Hyperbalanced diaphragm (Watertight chamber on T10-SC)
- 2 7/16" HP ports UNF - 4 3/8" LP ports UNF
- Operating pressure: INT version: 230 BAR | 3.336 PSI  
DIN version: 300 BAR | 4.351 psi  
Calibration pressure: 10 BAR | 146 psi
- High-capacity conical filter in chemically nickel-plated spherical bronze
- Removable nozzle in AISI 316 steel
- Hyperbalancing system
- Anti-pressure drop pneumatic spring
- Stainless steel calibration spring with micropeening treatment
- Low-friction technopolymer slider shaft
- Quantity of air supplied: 4.500 l/min 159 cu ft/min

**2<sup>ND</sup> STAGE**

- Pneumatically balanced
- Adjustable Venturi
- Adjustable inhalation effort
- Patented elliptical diaphragm
- Patented low-friction lever
- Air delivery system without injector
- Adjuster knob coated with PVD process with dual OR Internal heat exchanger
- Cap opening with Cam-lock
- Noise-absorbing technopolymer body
- Removable technopolymer deflector
- Removable mechanics

**COMBINATION PERFORMANCE**

- Average cracking effort: 1.41 in wc | 3.5 mBAR
- Average breathing effort: 0.6 J/l

**CERTIFICATION:** EN250/2014 FOR COLD WATER



CODE	PRODUCT	STYLE	CASE PACK
HX840000	T10-SC CROMO / MASTER CROMO (INT)	INT	1
HX840100	T10-SC CROMO / MASTER CROMO (DIN)	DIN	1

SPARE PARTS

CODE	PRODUCT
HZ800045	MAINTENANCE KIT for T10/T10-SC INT/DIN
HZ820080	MAINTENANCE KIT for MASTER/GALAXY/ELLIPSE BALANCED
HZ830035	DIN ASSEMBLY for T10/T10-SC
HZ730230	LP HOSE SAFEFLEX (black) (78 cm   30.7 in)

**COLD WATERS**  
CERTIFIED

Certification EN250/2014 for cold water.

The T10-SEAL CHAMBER 1ST stage is environmentally sealed, protecting it against icing in cold water and against contamination from particulate matter in silty conditions.



Version technically identical to the T10 Master with a durable satin chrome finish on the first stage and a brushed stainless steel cap on the second stage.

RESULTS: INHALE PRESSURE, EXHALE PRESSURE AND EXT WORK OF BREATHING

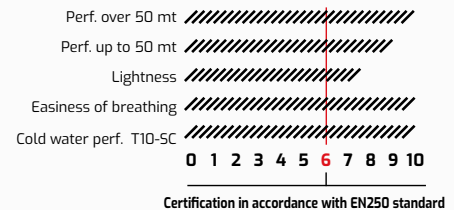
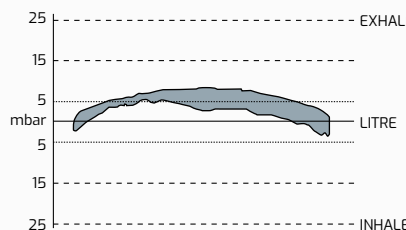



1<sup>ST</sup> STAGE

# AC25M

2<sup>ND</sup> STAGE

# MASTER CROMO

TOTAL WEIGHT

INT VERSION HOSE INCLUDED: 1123 G | 2 LB 14 OZ

SCUBALAB  
**BEST BUY**  
2 0 2 0



## TECHNICAL FEATURES

### 1<sup>ST</sup> STAGE

- 3rd generation Cressi's IP adjustable balanced piston first stage
- 2x 7/16" HP ports UNF
- 5x 3/8" LP ports UNF, 1 port on turret top
- Operating pressure:  
INT version: 230 BAR | 3,336 PSI  
DIN version: 300 BAR | 4,351 PSI
- Calibration pressure: 9.8-10 BAR | 142-146 PSI
- 360° revolving head
- Realized in brass-coated, with a matte finish
- The sintered conical filter protects from any impurity
- Flow rate: 4,500 l/min | 159 cu ft/min

### 2<sup>ND</sup> STAGE

- Pneumatically balanced
- Adjustable Venturi
- Adjustable inhalation effort
- Patented elliptical diaphragm
- Patented low-friction lever
- Air delivery system without injector
- Adjuster knob coated with PVD process with dual OR Laser-etched titanium front piece
- Internal heat exchanger
- Cap opening with Cam-lock
- Noise-absorbing technopolymer body
- Removable technopolymer deflector
- Removable mechanics

### COMBINATION PERFORMANCE

- Average breathing effort: 0.78 J/l

CERTIFICATION: EN250/2014 >10°C | 50 F

### RESULTS: INHALE PRESSURE, EXHALE PRESSURE AND EXT WORK OF BREATHING

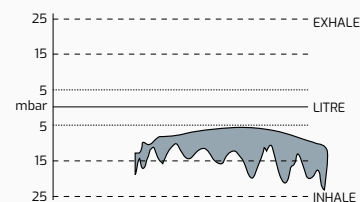

The AC25 is the third generation of Cressi's IP adjustable balanced piston first stage. It features 2 high-pressure ports and 5 low-pressure ports. 4 low-pressure ports are located on a rotating turret that ensures that regulator and instrument connections are always in the right position. The fifth port is a co-axial Hi-Flow port and is located at the top of the turret. The rotating turret swivels on 360° axis and features 5 low-pressure ports designed to allow the use of more connections without interfering between them. It features the external direct IP adjustment system that

can be set using a simple Allen key. The hi-flow conic shape filter is the same for INT and DIN. The spring and the spring bush are coated preventing rust. Its technologically advanced design delivers consistent intermediate pressure and high performance even with low tank pressures. The AC25m features a matte finish, in gun metal-coated brass. It is combined with the Master Cromo, the pneumatic balanced 2nd stage that features an elliptical shape and a lateral knob for Venturi adjustment.

CODE	PRODUCT	STYLE	CASE PACK
HX900000	AC25m / MASTER CROMO (INT)	INT	1

### SPARE PARTS

CODE	PRODUCT
HZ850017	MAINTENANCE KIT for AC25m/AC25g
HZ820080	MAINTENANCE KIT for MASTER/GALAXY/ELLIPSE BALANCED
HZ850018	DIN ASSEMBLY for AC25m
HZ730230	LP Hose SafeFlex (black) [78 cm   30.7 in]



1<sup>ST</sup> STAGE  
**MC9-SC**

2<sup>ND</sup> STAGE  
**COMPACT PRO**

TOTAL WEIGHT

INT VERSION HOSE INCLUDED:	946 G   2 LB 1 OZ
DIN VERSION HOSE INCLUDED:	803 G   1 LB 2 OZ



To obtain extremely high performance in low-temperature environments, the second stage has been designed with the special thermally conductive Thermoplastic Neopolymer which can transfer heat like metal while preserving the design flexibility, chemical resistance, and properties of physical and mechanical properties of a conventional thermoplastic. This drastically reduces weight while offering thermal conductivity equal to that of metal cases. Thanks to this material and a specially designed purge valve it passes the EN 250 cold water test.

MC9 SC  
INT VERSION

MC9 SC  
DIN VERSION

CODE	PRODUCT	STYLE	CASE PACK
HX782000	MC9-SC / COMPACT PRO (INT)	INT	1
HX782100	MC9-SC / COMPACT PRO (DIN)	DIN	1

SPARE PARTS

CODE	PRODUCT
HZ800047	MAINTENANCE KIT for MC9/MC9-SC/MC5 INT/DIN
HZ780060	MAINTENANCE KIT for COMPACT/COMPACT PRO
HZ782096	PURGE BUTTON (BLACK) for COMPACT PRO

**TECHNICAL FEATURES**

1<sup>ST</sup> STAGE

- Hyper-balanced 1st Stage
- Environmentally sealed Seal Chamber
- Light compact structure in chromium-plated brass with inner components in stainless steel, chromium-plated brass, and state-of-the-art thermoplastic resins
- High-capacity conical filter electroless nickel plated
- AISI 316 removable nozzle
- Anti-pressure drop pneumatic spring
- Semi-flexible elastomer body sheath for bumps and erosion protection
- 2 High-Pressure 7/16 UNF ports
- 4 Low-Pressure 3/8 UNF ports
- Service pressure (INT version): 232 BAR
- Calibration pressure: 10 BAR | 145 PSI
- DIN threaded connection EN ISO 1209
- INT/DIN connection complying with EN 250:2014 standard

2<sup>ND</sup> STAGE

- Downstream system
- Adjustable venturi effect
- Thermo conductive technopolymer body
- Big purge button
- Anti-scratch surface
- Bayonet-type cap holder with security lock
- Stainless steel cover
- Removable exhaust tee without tools
- Weight without hose: 153 g | 5.4 oz

COMBINATION PERFORMANCE

- Average Cracking effort 7.5 mBAR
- Average breathing effort 1.2 J/l
- Coldwater certification EN 250:2014
- Service pressure: 232 BAR | 3365 PSI
- Calibration pressure: 10 BAR | 145 PSI
- Complete INT regulator weight: 943 g | 33.3 oz
- Complete DIN regulator weight: 803 g | 28.3 oz

**COLD WATERS**  
CERTIFIED

CERTIFICATION EN250/2014 FOR COLD WATER.

The T10-SEAL CHAMBER 1ST stage is environmentally sealed, protecting it against icing in cold water and against contamination from particulate matter in silty conditions.

Results: inhale pressure, exhale pressure and ext work of breathing

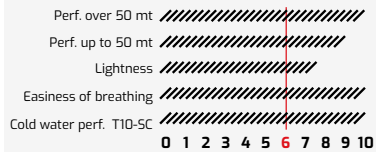
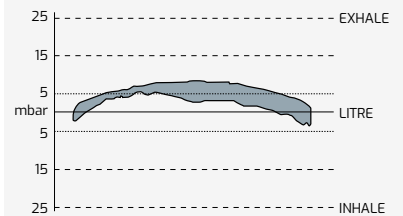

Certification in accordance with EN250 standard



1<sup>ST</sup> STAGE

**MC9**

2<sup>ND</sup> STAGE

**COMPACT**

TOTAL WEIGHT

INT VERSION HOSE INCLUDED: 878 G | 2 LB 1 OZ



MC9 INT

This premiere travel regulator packs maximum performance into minimum space. A true featherweight second stage, the compact is built from lightweight techno-polymers to eliminate jaw fatigue. Easy to pack and easy to dive, the compact includes a dive/pre-dive Venturi switch for managing free flow and maximizing performance at depth.



BLUE



BLACK



WHITE

CODE	PRODUCT	STYLE	CASE PACK
HX783020	MC9 / COMPACT (INT) - BLUE	INT	1
HX783051	MC9 / COMPACT (INT) - BLACK	INT	1
HX783151	MC9 / COMPACT (INT) - WHITE	INT	1

SPARE PARTS

CODE	PRODUCT
HZ800047	MAINTENANCE KIT for MC9/MC9-SC/MC5 INT/DIN
HZ780060	MAINTENANCE KIT for COMPACT/COMPACT PRO
HZ780064	PURGE BUTTON (WHITE) for COMPACT
HZ780067	PURGE BUTTON (BLACK) for COMPACT



TECHNICAL FEATURES

1<sup>ST</sup> STAGE

- Hyperbalanced diaphragm
- 2 7/16" HP ports UNF
- 4 3/8" LP ports UNF
- Operating pressure: INT version: 230 BAR | 3.336 PSI
- Calibration pressure: 9.8-10 BAR | 142-146 PSI
- Brass body Electroless Nickel plated
- High-capacity conical filter electroless nickel plated
- AISI 316 removable nozzle
- Hyper-balancing
- Anti-pressure drop pneumatic spring
- Setting spring: stainless steel with micropeening treatment
- Replaceable cylinder with anti-friction and anti-corrosion properties
- Elastomer protector
- Flow rate: 4.500 l/min | 159 cu ft/min

2<sup>ND</sup> STAGE

- Downstream system
- Adjustable Venturi effect
- Patented antifriction lever
- Ample purge button
- Anti-scratch surface
- Bayonet-type cap holder with security lock
- Removable exhaust tee without tools

COMBINATION PERFORMANCE

- Average Cracking effort: 6.0 mBAR | 2.41 in wc
- Average breathing effort 1.1 J/l

Jacketed hose: extremely light and flexible. Weight: 153 g | 5.4 oz

CERTIFICATIONS

- EN250 2014 A>10°C | 50 F

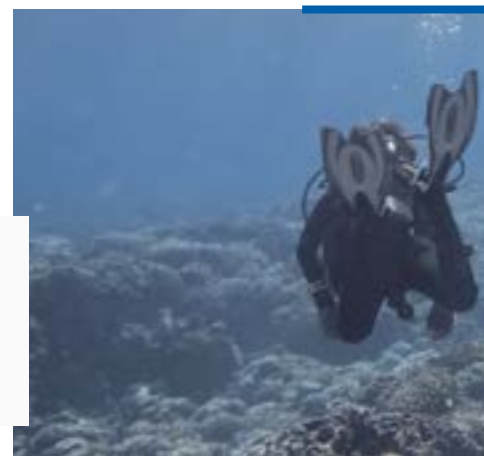
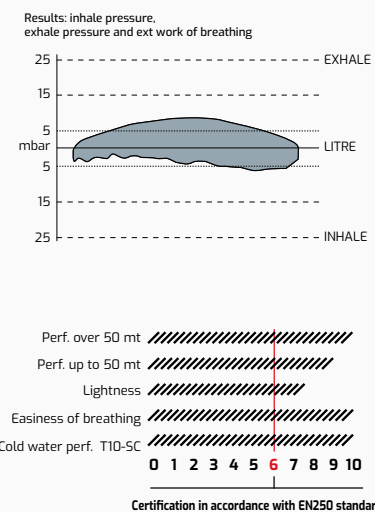



1<sup>ST</sup> STAGE

2<sup>ND</sup> STAGE

# AC2 COMPACT

TOTAL WEIGHT

INT VERSION HOSE INCLUDED: 923 G | 2 LB 0.5 OZ



AC2 INT

Ideal scuba diving regulator for beginners and travelers at an affordable price. Piston 1st stage plus a compact single-hull second stage. Simple piston 1st stage, a "work mule" that is affordable, simple, reliable, and robust, suitable for intense use. Greatly simplified single-hull 2nd stage made of ABS + elastomer of really compact size and extremely light. Its mechanism and development are perfectly planned to obtain the minimum number of components and great strength. Appreciated by dive centers and professional companies who consider it to be a very rentable tool, due to its low cost and practically nonexistent need for maintenance, as well as a surprising level of performance.

CODE	PRODUCT	STYLE	CASE PACK
HX787051	AC2 / COMPACT (INT) - SILVER	INT	1

SPARE PARTS

CODE	PRODUCT
HZ730150	MAINTENANCE KIT for AC2
HZ780060	MAINTENANCE KIT for COMPACT/COMPACT PRO
HZ780064	PURGE BUTTON (WHITE) for COMPACT
HZ780067	PURGE BUTTON (BLACK) for COMPACT

TECHNICAL FEATURES

1<sup>ST</sup> STAGE

- Piston design
- 1 7/16" HP ports UNF
- 4 3/8" LP ports UNF
- Operating pressure: INT version: 230 BAR | 3,336 PSI
- Calibration pressure: 9.8-10 BAR | 142-146 PSI
- Brass body electroless nickel plated
- High-capacity conical filter electroless nickel plated
- Long-lasting piston: AISI 316 stainless steel
- Easy external direct IP adjustment system
- Stainless steel spring
- Flow rate: 2,100 l/min | 74.16 cu ft/min

2<sup>ND</sup> STAGE

- Downstream system
- Adjustable Venturi effect
- Patented antifriction lever
- Ample purge button
- Anti-scratch surface
- Bayonet-type cap holder with security lock
- Removable exhaust tee without tools

COMBINATION PERFORMANCE

- Average cracking effort: 6.0m BAR | 2.41 in wc
- Average breathing effort 1.2 J/l

Jacketed hose: extremely light and flexible. Weight: 153 g | 5.4 oz

CERTIFICATIONS

- EN250 2014 A>10°C

RESULTS: INHALE PRESSURE, EXHALE PRESSURE AND EXT WORK OF BREATHING

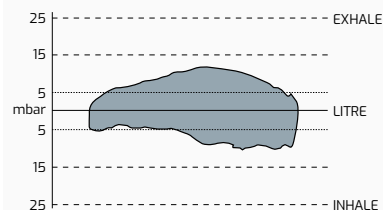

DIRECT IP ADJUSTMENT SYSTEM (no shims required)

EXTERIOR LP REGULATION FACILITATES MANAGING ADJUSTMENTS AND TECHNICAL MAINTENANCE



Photo by: voyagesofagape



1<sup>ST</sup> STAGE      2<sup>ND</sup> STAGE

# AC2      XS2

TOTAL WEIGHT

INT VERSION HOSE INCLUDED:    994 G | 2 LB 3 OZ



It is the entry-level regulator designed for beginners and rental operations. Constantly reviewed over the years, this regulator has lots of admirers in the world due to the fact that it is extremely simple and strong, features that make it easy to use and result in low-cost maintenance.

## TECHNICAL FEATURES

### 1<sup>ST</sup> STAGE

- Piston design
- 1 7/16" HP ports UNF
- 4 3/8" LP ports UNF
- Operating pressure: INT version: 230 BAR | 3.336 PSI
- Calibration pressure: 9.8-10 BAR | 142-146 PSI
- Brass body electroless nickel plated
- High capacity conical filter electroless nickel plated
- Long-lasting piston: AISI 316 stainless steel
- Easy external direct IP adjustment system
- Stainless steel spring
- Flow rate: 2,100 l/min | 74.16 cu ft/min

### 2<sup>ND</sup> STAGE

- Downstream system
- Adjustable Venturi effect
- Easy maintenance
- Adjustable intermediate pressure from the outside of the regulator due to our patented design

### COMBINATION PERFORMANCE

- Average Cracking effort: 10 mBAR | 4 in wc
- Average breathing effort 1.5 J/l

**JACKETED HOSE:** EXTREMELY LIGHT AND FLEXIBLE.

**WEIGHT:** 53 G | 5.4 OZ

**CERTIFICATIONS:** EN250 2014 A>10°C

**TOTAL WEIGHT**

INT VERSION: 994 G · 2 LB 3 OZ

CODE	PRODUCT	STYLE	CASE PACK
HX780000	AC2 / XS2 (INT)	INT	1

### SPARE PARTS

CODE	PRODUCT
HZ730150	MAINTENANCE KIT for AC2
HZ790090	MAINTENANCE KIT for XS/XS2/OCTOPUS XS
HZ780067	PURGE BUTTON (BLACK) for COMPACT

DIRECT IP ADJUSTMENT SYSTEM (no shims required)

EXTERIOR LP REGULATION FACILITATES MANAGING ADJUSTMENTS AND TECHNICAL MAINTENANCE



### RESULTS: INHALE PRESSURE, EXHALE PRESSURE AND EXT WORK OF BREATHING

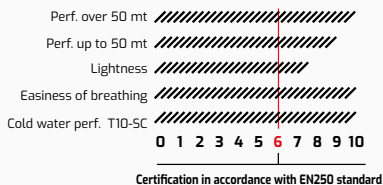
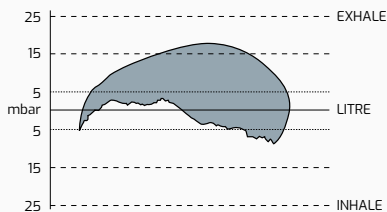

Cold water perf. T10-SC

0 1 2 3 4 5 6 7 8 9 10

Certification in accordance with EN250 standard







1<sup>ST</sup> STAGE    2<sup>ND</sup> STAGE    OCTOPUS  
**MC9 COMPACT COMPACT** NEW 2024



**TECHNICAL FEATURES**

- 1<sup>ST</sup> STAGE**
- Hyperbalanced diaphragm
  - 2 7/16" HP ports UNF
  - 4 3/8" LP ports UNF
  - Operating pressure: INT version: 230 BAR | 3,336 PSI
  - Calibration pressure: 9.8-10 BAR | 142-146 PSI
  - Brass body Electroless Nickel plated
  - High-capacity conical filter electroless nickel plated
  - AISI 316 removable nozzle
  - Hyper-balancing
  - Anti-pressure drop pneumatic spring
  - Setting spring: stainless steel with micropeening treatment
  - Replaceable cylinder with anti-friction and anti-corrosion properties
  - Elastomer protector
  - Flow rate: 4,500 l/min | 159 cu ft/min
- 2<sup>ND</sup> STAGE**
- Downstream system
  - Adjustable Venturi effect
  - Patented antifriction lever
  - Ample purge button
  - Anti-scratch surface
  - Bayonet-type cap holder with security lock
  - Removable exhaust tee without tools
- COMBINATION PERFORMANCE**
- Average Cracking effort: 6.0 mBAR | 2.41 in wc
  - Average breathing effort 1.1 l/l
- JACKETED HOSE: EXTREMELY LIGHT AND FLEXIBLE.**  
**WEIGHT:** 153 g | 5.4 oz  
**CERTIFICATIONS:** EN250 2014 A>10°C | 50 F

A complete regulator set ideal for travelers, beginners, and rental operations. It's composed of the high-performance 1st stage and the featherweight Compact 2nd stage to eliminate jaw fatigue. Easy to pack and easy to dive, the compact includes a dive/pre-dive Venturi switch for managing free flow and maximizing performance at depth.



MC9 COMPACT INT



DIRECT IP ADJUSTMENT SYSTEM  
(no shims required)



CODE	PRODUCT	STYLE	CASE PACK
WHY783051	MC9 / COMPACT + OCTOPUS COMPACT (INT)	INT	1



1<sup>ST</sup> STAGE    2<sup>ND</sup> STAGE    OCTOPUS  
**AC2 COMPACT COMPACT**



This premiere complete set regulator maximises performance into minimum space. A true featherweight second stage, the compact is built from lightweight techno-polymers to eliminate jaw fatigue. Easy to pack and easy to dive, the compact includes dive/pre-dive venturi switch for managing freeflow and maximizing performance at depth.

AC2 COMPACT INT

AC2 COMPACT DIN

CODE	PRODUCT	STYLE	CASE PACK
HY787051	AC2 / COMPACT + OCTOPUS COMPACT (INT) INT		1

SPARE PARTS

CODE	PRODUCT
HZ730150	MAINTENANCE KIT for AC2
HZ780060	MAINTENANCE KIT for COMPACT/COMPACT PRO
HZ780067	PURGE BUTTON (BLACK) for COMPACT
HZ780066	PURGE BUTTON (YELLOW) for COMPACT

**TECHNICAL FEATURES**

1<sup>ST</sup> STAGE

- Piston design
- 17/16" HP ports UNF
- 4 3/8" LP ports UNF
- Operating pressure: INT version: 230 BAR | 3.336 PSI
- Calibration pressure: 9.8-10 BAR | 142-146 PSI
- Brass body electroless nickel plated
- High-capacity conical filter electroless nickel plated
- Long-lasting piston: AISI 316 stainless steel
- Easy external direct IP adjustment system
- Stainless steel spring
- Flow rate: 2.100 l/min | 74.16 cu ft/min

2<sup>ND</sup> STAGE AND OCTOPUS

- Downstream system
- Adjustable Venturi effect
- Patented antifriction lever
- Ample purge button
- Anti-scratch surface
- Bayonet-type cap holder with security lock
- Removable exhaust tee without tools

COMBINATION PERFORMANCE

- Average cracking effort: 6.0m BAR | 2.41 in wc
- Average breathing effort 1.2 J/l

JACKETED HOSE: EXTREMELY LIGHT AND FLEXIBLE.  
 WEIGHT: 153 g | 5.4 oz  
 CERTIFICATIONS: EN250 2014 A>10°C

RESULTS: INHALE PRESSURE, EXHALE PRESSURE AND EXT WORK OF BREATHING

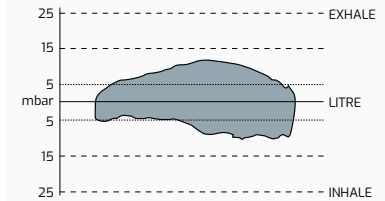

DIRECT IP ADJUSTMENT SYSTEM (no shims required)

EXTERIOR LP REGULATION FACILITATES MANAGING ADJUSTMENTS AND TECHNICAL MAINTENANCE



OCTOPUS  
**MG BALANCED**



**TECHNICAL FEATURES**

- Pneumatically balanced
- Venturi effect adjustment
- Patented elliptical membrane
- Patented low-friction lever
- Air delivery system without injector
- Internal heat exchange
- Cam-lock system to open the case
- Body in noise-absorbent technopolymer
- Removable technopolymer deflector
- Removable mechanical parts

**CERTIFICATIONS**  
Annex B EN 250: 2014 for cold water

**TOTAL WEIGHT**  
335 g | 12 oz Yellow LP Octopus hose.  
Weight: 171 g · 6.0 oz, length: 100 cm · 39 1/2 in

It is a pneumatically balanced valve designed with a Venturi effect adjustment switch, Cressi's patented elliptical membrane diaphragm, and a patented low-friction lever. The Octopus regulator air delivery system without an injector has an internal heat exchange, a cam-lock system to open the case, and a

body in noise-absorbent techno Polymer. Removable techno Polymer deflector and removable mechanical parts. The hose is extremely light and flexible. The hose and the purge cover are in bright yellow color for easy identification in an out-of-air emergency.



CODE	PRODUCT	CASE PACK
HX880000	OCTOPUS MG BALANCED	1

SPARE PARTS

CODE	PRODUCT
HZ780083	PURGE BUTTON (YELLOW) for OCTOPUS MG BALANCED
HZ820080	MAINTENANCE KIT for MASTER/GALAXY/ELLIPSE BALANCED
HZ730225	LP OCTOPUS HOSE (YELLOW) 100 cm   39.5 in
HZ730228	HOSE PROTECTOR (YELLOW)



OCTOPUS  
**COMPACT PRO**



**TECHNICAL FEATURES**

- Downstream system
- Adjustable venturi effect
- Patented antifriction lever
- Thermoconductive technopolymer body
- Ample purge button
- Anti-scratch surface
- Bayonet-type cap holder with security lock
- Stainless steel cover
- Removable exhaust tee without tools
- Weight: 293 g · 10.3 oz
- Yellow LP Octopus hose, Weight: 171 g · 6.0 oz, length: 100 cm · 39 1/2 in

**CERTIFICATIONS**  
Annex B EN 250:2014\_ A>10°C



CODE	PRODUCT	CASE PACK
HX789500	OCTOPUS COMPACT PRO	1

SPARE PARTS

CODE	PRODUCT
HZ780060	MAINTENANCE KIT for COMPACT/COMPACT PRO
HZ780052	PURGE BUTTON (YELLOW) for OCTOPUS COMPACT
HZ730225	LP OCTOPUS HOSE (YELLOW) 100 cm   39.5 in
HZ730228	HOSE PROTECTOR (YELLOW)





OCTOPUS

**COMPACT**



**TECHNICAL FEATURES**

- Downstream system
- Adjustable venturi effect
- Patented antifriction lever
- Anti-scratch surface
- Bayonet-type cap holder with security lock
- Removable exhaust tee without tools
- Weight without hose: 135 g · 4.76 oz
- Ample purge button
- Yellow LP Octopus hose. Weight: 171 g · 6.0 oz, length: 100 cm · 39 1/2 in

**CERTIFICATIONS**  
Annex B EN 250:2014\_ A>10°C

CODE	PRODUCT	CASE PACK
HX789000	OCTOPUS COMPACT	1

SPARE PARTS

CODE	PRODUCT
HZ780060	MAINTENANCE KIT for COMPACT/COMPACT PRO
HZ780066	PURGE BUTTON (YELLOW) for COMPACT
HZ730225	LP OCTOPUS HOSE (YELLOW) 100 cm   39.5 in
HZ730228	HOSE PROTECTOR (YELLOW)



OCTOPUS

**XS2**



**TECHNICAL FEATURES**

- Downstream system
- Adjustable venturi effect
- Easy maintenance
- Total weight: 359 g · 12.7 oz
- Yellow LP Octopus hose. Weight: 171 g · 6.0 oz, length: 100 cm · 39 1/2 in

**CERTIFICATIONS**  
Annex B EN 250:2014\_ A>10°C | 50 F

Proven and highly affordable, the Octopus XS2 is ideal for any diver looking for maximum value. Its low maintenance and ultra reliable design also make it a favorite among dive schools and rental centers.

CODE	PRODUCT	CASE PACK
HX770098	OCTOPUS XS2	1

SPARE PARTS

CODE	PRODUCT
HZ790090	MAINTENANCE KIT for XS/XS2/OCTOPUS XS
HZ730225	LP OCTOPUS HOSE (YELLOW) 100 cm   39.5 in
HZ730228	HOSE PROTECTOR (YELLOW)



# REGULATORS COMPARISON CHART

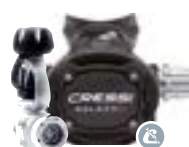

	<b>T10-SC CROMO GALAXY-R</b>	<b>T10-SC CROMO GALAXY</b>	<b>T10-SC PVD MASTER BALANCED</b>	<b>T10-SC MASTER CROMO</b>	<b>AC25M MASTER CROMO</b>
<b>INT Version Available</b>	Yes	Yes	Yes	Yes	Yes
<b>DIN Version Available in America</b>	Yes	Yes	Yes	Yes	No
<b>Weight (Hose Included)</b>	INT 1.055 g   2 lb 5 oz DIN 937 g   2 lb 1 oz	INT 1055 g   2 lb 5 oz DIN 937 g   2 lb 1 oz	INT 1080 g   2 lb 6 oz DIN 962 g   2 lb 2 oz	INT 1080 g   2 lb 6 oz DIN 962 g   2 lb 2 oz	INT 1293 g   2 lb 14 oz
<b>Certified For Cold Water</b>	EN250/2014 <10° C (50 F)	EN250/2014 <10° C   50 F	EN250/2014 <10° C   50 F	EN250/2014 <10° C   50 F	EN250/2014 >10° C   50 F
<b>PERFORMANCE</b>					
<b>Working Pressure</b>	INT 0-232 BAR   0-3,365 PSI DIN 0-300 BAR   0-4,350 PSI	INT 0-232 BAR   0-3,365 PSI DIN 0-300 BAR   0-4,350 PSI	INT 0-232 BAR   0-3,365 PSI DIN 0-300 BAR   0-4,350 PSI	INT 0-232 BAR   0-3,365 PSI DIN 0-300 BAR   0-4,350 PSI	INT 0-232 BAR   0-3,365 PSI
<b>Calibration Pressure</b>	9.8-10 BAR   142-146 PSI	9.8-10 BAR   142-146 PSI	9.8-10 BAR   142-146 PSI	9.8-10 BAR   142-146 PSI	9.8-10 BAR   142-146 PSI
<b>Air Supply Air Pressure at 200-150 BAR</b>	159 cu ft/min 4500 l/min	159 cu ft/min 4500 l/min	159 cu ft/min 4500 l/min	159 cu ft/min 4500 l/min	99 cu ft/min 2800 l/min
<b>Average Cracking Effort</b>	3.5 mBAR 1.41 inwc	3.5 mBAR 1.41 inwc	3.5 mBAR 1.41 inwc	3.5 mBAR 1.41 inwc	
<b>Average Inhalation Effort</b>	3 mBAR	3 mBAR	3 mBAR	3 mBAR	9.9 mBAR
<b>Average Exhalation Effort</b>	7 mBAR	7 mBAR	7 mBAR	7 mBAR	8.1 mBAR
<b>Average Breathing Effort</b>	0.6 J/l	0.6 J/l	0.6 J/l	0.6 J/l	0.78 J/l
<b>1<sup>ST</sup> STAGE</b>					
<b>Type</b>	Hyperbalanced Diaphragm	Hyperbalanced Diaphragm	Hyperbalanced Diaphragm	Hyperbalanced Diaphragm	Balanced Piston
<b>HP Ports</b>	2 7/16" UNF	2 7/16" UNF	2 7/16" UNF	2 7/16" UNF	2 7/16" UNF
<b>LP Ports</b>	4 3/8" UNF	4 3/8" UNF	4 3/8" UNF	4 3/8" UNF	5 3/8" UNF
<b>2<sup>ND</sup> STAGE</b>					
<b>Type</b>	Adjustable Pneumatically Balanced	Pneumatically Balanced	Adjustable Pneumatically Balanced	Adjustable Pneumatically Balanced	Pneumatically Balanced



	<b>MC9-SC COMPACT PRO</b>	<b>MC9 COMPACT</b>	<b>AC2 COMPACT</b>	<b>AC2 XS2</b>
<b>INT Version Available</b>	Yes	Yes	Yes	Yes
<b>DIN Version Available in America</b>	Yes	No	No	No
<b>Weight (Hose Included)</b>	INT 943 g 2 lb 1 oz	INT 878 g 2 lb 1 oz	INT 923 g 2 lb 0.5 oz	INT 994 g 2 lb 3 oz
<b>Certified For Cold Water</b>	EN250/2014	EN250/2014 >10° C   50 F	EN250/2014 >10° C   50 F	EN250/2014 >10° C   50 F
<b>PERFORMANCE</b>				
<b>Working Pressure</b>	INT 0-232 BAR 0-3.365 PSI	INT 0-232 BAR 0-3.365 PSI	INT 0-232 BAR 0-3.365 PSI	INT 0-232 BAR 0-3.365 PSI
<b>Calibration Pressure</b>	9.8-10 BAR 142-146 PSI	9.8-10 BAR 142-146 PSI	9.8-10 BAR 142-146 PSI	9.8-10 BAR 142-146 PSI
<b>Air Supply</b> <small>Air Pressure at 200-150 BAR</small>	159 cu ft/min 4,500 l/min	159 cu ft/min 4500 l/min	74 cu ft/min 2100 l/min	74 cu ft/min 2100 l/min
<b>Average Cracking Effort</b>	2.41 inwc 6 mBAR	2.41 inwc 6 mbar	2.41 inwc 6 mbar	4 inwc 10 mbar
<b>Average Inhalation Effort</b>	5 mBAR	5 mBAR	5 mBAR	12 mBAR
<b>Average Exhalation Effort</b>	10 mBAR	10 mBAR	10 mBAR	17 mBAR
<b>Average Breathing Effort</b>	1.1 J/l	1.1 J/l	1.2 J/l	1.5 J/l
<b>1<sup>ST</sup> STAGE</b>				
<b>Type</b>	Hyperbalanced Diaphragm	Hyperbalanced Diaphragm	Balanced Piston	Balanced Piston
<b>HP Ports</b>	2 7/16" UNF	2 7/16" UNF	1 7/16" UNF	1 7/16" UNF
<b>LP Ports</b>	4 3/8" UNF	4 3/8" UNF	4 3/8" UNF	4 3/8" UNF
<b>2<sup>ND</sup> STAGE</b>				
<b>Type</b>	Downstream System	Downstream System	Downstream System	Downstream System

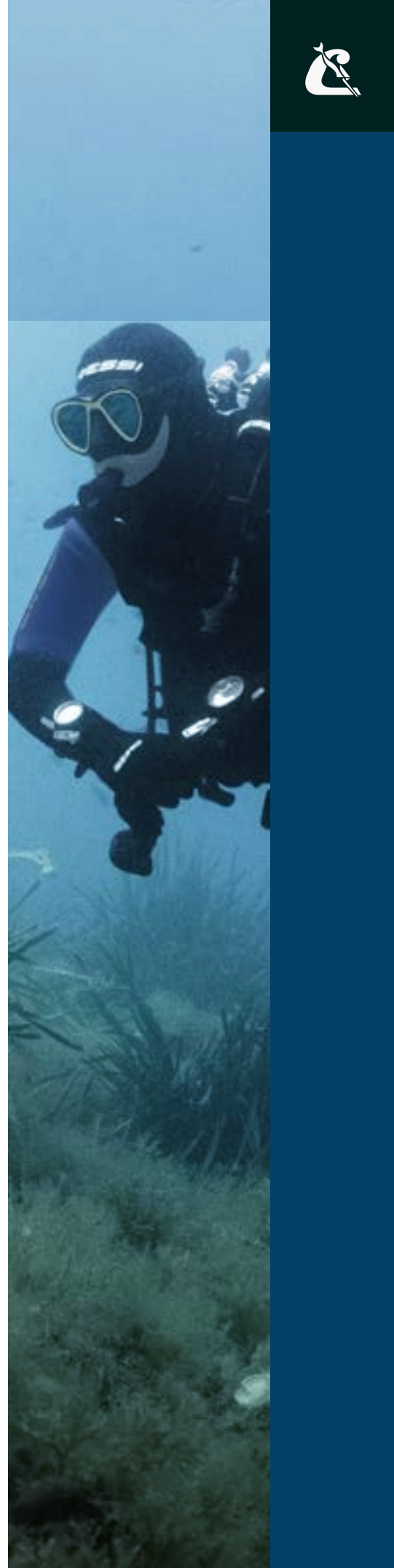



# REGULATOR ACCESSORIES

SCUBA



## T10-SC CROMO \*

CODE	PRODUCT
HZ991006	T10-SC CROMO INT 1st STAGE ONLY
HZ991007	T10-SC CROMO DIN 1st STAGE ONLY

DESCRIPTION:  
Hyperbalanced T shape diaphragm 1st stage with seal chamber system, chrome finishing.

\*SEE COMPATIBILITY WARNINGS!



## AC25M \*

CODE	PRODUCT
HZ900003	AC25m BALANCED PISTON MATTE 1st STAGE (INT)

DESCRIPTION:  
Revolving turret balanced piston 1st stage, gun-metal chrome finishing, external IP direct adjustment system.

\*SEE COMPATIBILITY WARNINGS!



## MC9-SC \*

CODE	PRODUCT
HZ820095	MC9-SC (INT) 1st STAGE ONLY
HZ820096	MC9-SC (DIN) 300 BAR 1st STAGE

DESCRIPTION:  
Hyperbalanced in-line shape diaphragm 1st stage with seal chamber system.

\*SEE COMPATIBILITY WARNINGS!



\* COMPATIBILITY WARNINGS!

The 1st stages and hoses are sold ONLY as a replacement for the regulator combination for which its use is envisaged under the regulatory requirements in force. Therefore it may only be used as a replacement for the combination with second stages called for in the EC certificate for the type that concern it as well as the EC declaration of conformity for the product according to Regulation (EU) 2016/425, which can be viewed at [www.cressi.com](http://www.cressi.com). Cressi Sub declines all responsibility for any other use that does not conform with the requirements dictated by the regulations in force.

The combinations of the certified Cressi regulators are contained in the last page of the Regulator user manual which can be read or downloaded from [www.cressi.com](http://www.cressi.com) using the following QR Code:



## REGULATOR BAG 360 REGULATOR BAG

The 360 Regulator Bag is a case for protecting scuba diving regulators and octopus. Features an adjustable shoulder strap for carrying your equipment. Made in strong nylon for long lasting use. The foam lining acts as a protective covering. The closure is with YKK zip that ensures a perfect seal.



### TECHNICAL FEATURES

- Made in strong nylon for long lasting use
- Foam lining acts as a protective covering
- The closure is with YKK zip that ensures a perfect seal
- Velcro strap on back of case for easy attachment to luggage for travel

CODE	PRODUCT	CASE PACK
UB940000	360 REGULATOR BAG - BLACK/BLACK	12

## DIN CONVERSION KIT



AC25M



AC2



MC9/MC5



T10/T10-SC

## INT ADAPTOR



INT YOKE UNIVERSAL ADAPTOR FOR DIN 1<sup>ST</sup> STAGE

CODE	PRODUCT
HZ800067	DIN ASSEMBLY 300 BAR for MC5/MC9/MC9-SC
HZ735157	DIN ASSEMBLY 300 BAR for AC2
HZ830035	DIN ASSEMBLY for T10/T10-SC
HZ850018	DIN ASSEMBLY for AC25m
HZ840001	DIN TO YOKE UNIVERSAL ADAPTOR

## GALAXY PURGE BUTTON



CODE	PRODUCT
HZ820090	PURGE BUTTON for GALAXY-R 2nd STAGE - BLACK
HZ820088	PURGE BOTTON for GALAXY - BLACK
HZ780083	PURGE BUTTON (YELLOW) for OCTOPUS MG BALANCED

## COMPACT PRO PURGE BUTTON



CODE	COLOR
HZ782096	Black
HZ780052	Yellow

## XS2 COVER



CODE	COLOR
HZ780050	Black/Grey
HZ780051	Black/Yellow



## LP HOSE



YELLOW

BLACK

CODE	PRODUCT
HZ730225	LP OCTOPUS HOSE [YELLOW] (101 cm - 39.5 in)
HZ730222	LP REGULATOR HOSE [BLACK] (78 cm - 30.5 in)

## LP SAFEFLEX HOSE

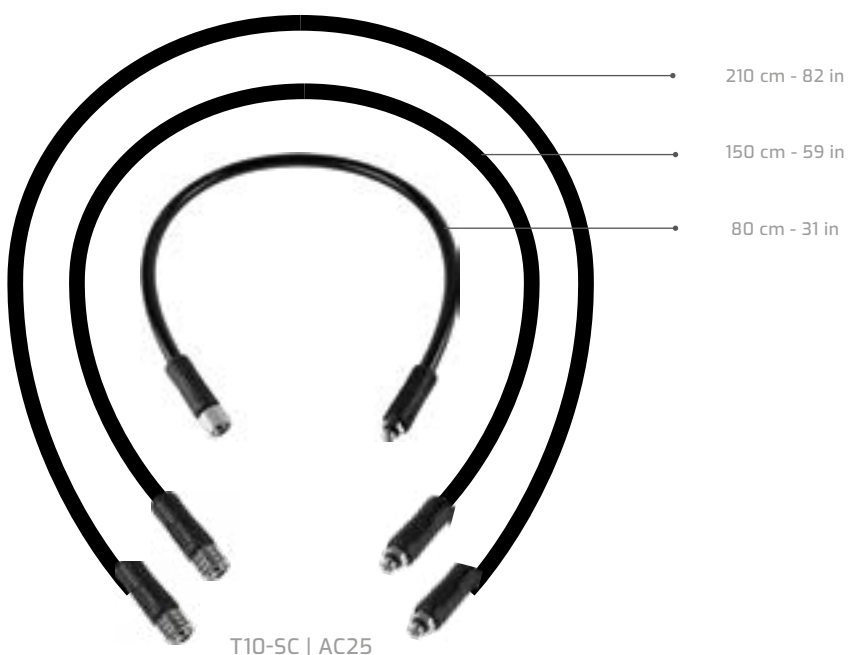

T10-SC | AC25

CODE	SIZE
HZ730230	80 cm · 31 in
HZ730231	150 cm · 59 in
HZ730232	210 cm · 82 in

## HOSE PROTECTOR



BLACK

YELLOW

CODE	PRODUCT
HZ730224	BLACK
HZ730228	YELLOW

## MAGNETIC OCTOPUS HOLDER



The Magnetic Octopus Holder keeps the equipment in its place, close to the jacket. It can be used for the safety octopus, pressure gauge, or for other additional instruments.

CODE
TA700002

## 2<sup>ND</sup> STAGE MOUTHPIECE



CODE
HZ790094

# TECHNICAL SCHEME POSTERS

CODE	PRODUCT
VPOSTERTGR	TECHNICAL DRAWING POSTER of T10SC CROMO/GALAXY-R REGULATOR
VPOSTERTM	TECHNICAL DRAWING POSTER of T10-SC/MASTER REGULATOR
VPOSTERTMC	TECHNICAL DRAWING POSTER of T10-SC/MASTER CROMO REGULATOR



# MAINTENANCE KITS

In a blister pack, we have included all the components to be changed when performing maintenance on both the first and second stages. Maintenance is only to be performed by Cressi Authorized Service Centers.



### 1<sup>ST</sup> STAGE

CODE	PRODUCT
HZ800045	MAINTENANCE KIT for T10/T10-SC INT/DIN
HZ800047	MAINTENANCE KIT for MC9/MC9-SC/MC5 INT/DIN
HZ850017	MAINTENANCE KIT for AC25m/AC25g
HZ735050	MAINTENANCE KIT for AC10V
HZ730150	MAINTENANCE KIT for AC2

### 2<sup>ND</sup> STAGE

CODE	PRODUCT
HZ820080	MAINTENANCE KIT for MASTER/GALAXY/ELLIPSE BALANCED
HZ810067	MAINTENANCE KIT for ELLIPSE (NOT BALANCED)
HZ780060	MAINTENANCE KIT for COMPACT/COMPACT PRO
HZ790090	MAINTENANCE KIT for X5/X52/OCTOPUS X5

# SERVICE & REPAIR

NEW 2024

## SERVICE TOOL KIT

A practical tool kit that contains the most important tools for doing the maintenance and service of the regulators, BCD, and spearguns. The Libra is a practical bag for storing and carrying tools and thanks to its card pouch it can be personalized.



## REGULATOR MOBILE TEST BENCH



CODE
HZ710004

CODE
HZ709030

## DYNAMOMETRIC WRENCH SET



CODE  
HZ709021

## NEOPRENE MAT FOR REGULATOR MAINTENANCE



CODE  
HZ710003

## SILICONE GREASE

60 g



CODE  
HZ704060

## SINGLE TOOL

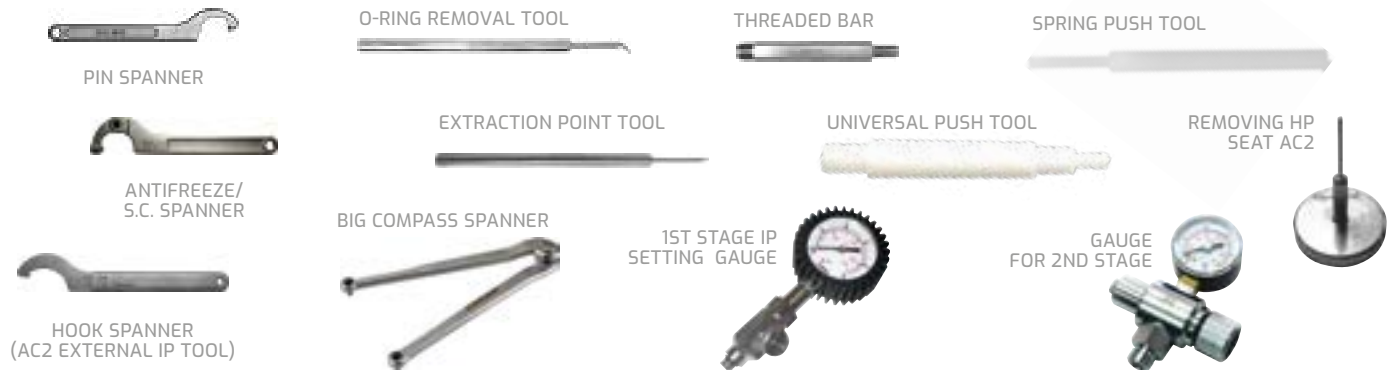

CODE	PRODUCT
HZ709002	SPANNER for ANTIFREEZE / SEAL CHAMBER
HZ709003	BIG COMPASS SPANNER for S.C.
HZ709004	EXTRACTION POINT TOOL for 1st STAGES
HZ709005	CIRCLIP PLIERS for 1st STAGES
HZ709006	ALLEN KEY 6mm
HZ709007	ALLEN KEY 4mm
HZ709008	THREADED BAR TO TIGHTEN THE 1st STAGE IN THE VICE
HZ709009	NUT DRIVER 5.5mm
HZ709010	JIG ADJUSTMENT for ELLIPSE 2nd STAGE
HZ709011	PUSH TOOL for 2nd STAGES
HZ709012	SOCKET WRENCH REMOVER TOOL
HZ709013	SMALL COMPASS SPANNER for 2nd STAGE
HZ709016	O-RING REMOVAL TOOL
HZ709017	EXTRACTION PLIER
HZ709018	YOKE REMOVING TOOL
HZ709019	REMOVING HP SEAT AC2
HZ710010	IP SETTING GAUGE for REGULATOR 1st STAGE
HZ710011	PRESSURE SETTING GAUGE for 2nd STAGE
HZ739001	UNIVERSAL PUSH TOOL
HZ739002	OGIVAL TOOL O-RING BULLIT for 1st STAGE
HZ739003	PIN SPANNER
HZ739051	HOOK SPANNER (AC2 EXTERNAL IP TOOL)





**B.C.D.**  
SCUBA



# AQUAWING MAX NEW 2024

HIGH BUOYANCY + ONE SIZE FITS ALL + WEIGHT POCKETS



## TECHNICAL FEATURES

- Unisex
- One-size-fits-all
- MAS (Modular Adjustment System)
- Extra back weight 2.5 kg · 5.5 lb

## BUOYANCY

SIZE	NEWTON	KG	LB
XS-XL	170	17.33	38.21

## PRODUCT WEIGHT

SIZE	KG	LB
XS-XL	3.90	8.6



Aquawing Max is the one-size donut jacket designed to adapt to all anatomies (male and female) using the new patented mas (modular adjustment system): the single 50 mm belt that embraces the shoulders and waist can be rapidly adjusted to your size. The bag's profile is designed to ensure perfect buoyancy with a single tank, and the increased volume generates a buoyancy of 170 N, making the Jacket particularly suitable for dives with increased ballast, such as in cold water to compensate for the high thickness of wetsuits. The anodized light alloy backplate reduces the overall weight of the

jacket while guaranteeing stability and safety in use. The special cylinder rest in thermoplastic rubber integrated with the back of the jacket guarantees the positioning of the tank for optimum trim. The shoulder straps and back cover are made with an air-net material to enhance comfort and improve water drainage. The jacket is equipped with two weight pockets attached directly to the back plate in correspondence with your flanks. The back cover is equipped with a special pocket designed to house the decompression buoy.

CODE	PRODUCT
IC790200	AQUAWING MAX BCD XS/XL

### ACCESSORIES

CODE	PRODUCT
IZ790400	AQUAWING PLATE WEIGHT 2.5 kg
IZ790300	AQUAWING WEIGHT POCKET
IZ790200	AQUAWING MODULAR SYSTEM KIT



**PATENTED MODULAR ADJUSTMENT SYSTEM**  
THE SINGLE BELT THAT EMBRACES THE SHOULDERS AND WAIST CAN BE RAPIDLY ADJUSTED



BACK COVER POCKET

AIR-NET MATERIAL



EQUIPPED WITH WEIGHT POCKETS



# AQUAWING PLUS

ONE SIZE FITS ALL + WEIGHT POCKETS



ANODISED LIGHT ALLOY BACK PLATE

WEIGHT POCKETS INCLUDED

MODULAR ADJUSTMENT SYSTEM

TECHNICAL FEATURES	
· Unisex	
· One-size-fits-all	
· Air chamber fabric: 210 Denier nylon	
· Air chamber cover: 1500 Denier Cordura	
· MAS (Modular Adjustment System)	
· 5 Stainless steel D-rings	
· 2 weight pockets	

BUOYANCY			
SIZE	NEWTON	KG	LB
XS-XL	130	13.3	29.3

PRODUCT WEIGHT		
SIZE	KG	LB
XS-XL	2.90	6.39



**PATENTED MODULAR ADJUSTMENT SYSTEM**  
THE SINGLE BELT THAT EMBRACES THE SHOULDERS AND WAIST CAN BE RAPIDLY ADJUSTED

The Aquawing Plus is the one-size-fits-all wing-style scuba BCD designed to adapt to all anatomies using the patented MAS (Modular Adjustment System). The single 50 mm belt that embraces the shoulders and waist can be quickly adapted to the diver's size. The shape of the air chamber has been designed to ensure perfect buoyancy with a single cylinder. The anodized light alloy backplate reduces the overall weight of the jacket while guaranteeing stability and safety in use. The particular cylinder rest in

thermoplastic rubber integrated with the back of the jacket guarantees the positioning of the tank for optimum trim. The shoulder straps and back cover are made with an air-net material to enhance comfort and improve water drainage. The jacket is equipped with two weight pockets attached directly to the belt in correspondence with the hips. The back cover is equipped with a special pocket designed to store an SMB.



CODE	PRODUCT
IC79010	AQUAWING PLUS BCD XS/XL

ACCESSORIES

CODE	PRODUCT
IC760099	TANK STRAP WEIGHT POCKET
I2790400	AQUAWING PLATE WEIGHT 2.5 kg
I2790300	AQUAWING WEIGHT POCKET
I2790200	AQUAWING MODULAR SYSTEM KIT

SPARE PARTS

CODE	PRODUCT
I2750275	O-RING MAINTENANCE KIT for BCD INFLATOR FLAT

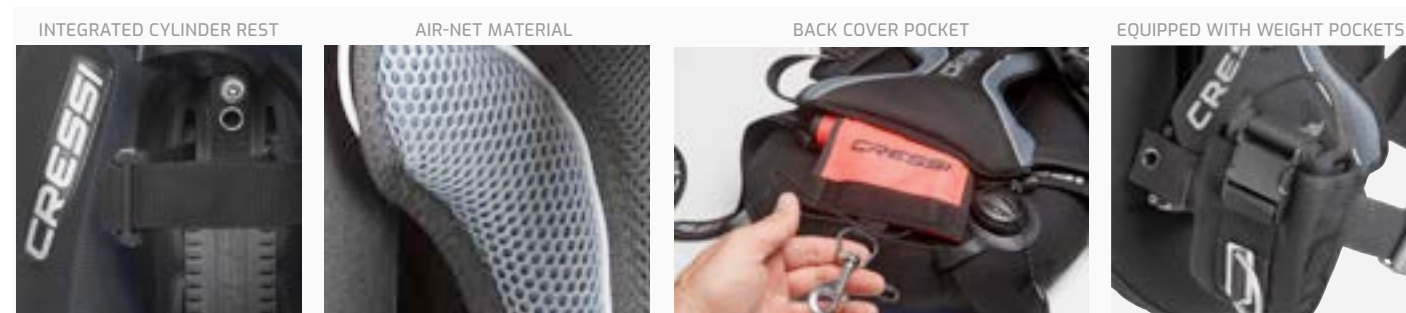



# AQUAWING

ONE SIZE FITS ALL



ANODISED LIGHT ALLOY BACK PLATE

MODULAR ADJUSTMENT SYSTEM

## TECHNICAL FEATURES

- Unisex
- One-size-fits-all
- Air chamber fabric: 210 Denier nylon
- Air chamber cover: 1500 Denier Cordura
- MAS (Modular Adjustment System)
- 5 Stainless steel D-rings

## BUOYANCY

SIZE	NEWTON	KG	LB
XS-XL	130	13.3	29.3

## PRODUCT WEIGHT

SIZE	KG	LB
XS-XL	2.90	6.39

OPTIONAL D-RING



OPTIONAL WEIGHT POCKET



Aquawing is the one-size donut jacket designed to adapt to all anatomies (male and female) using the new patented MAS (Modular Adjustment System); in fact, the single 50 mm belt that embraces the shoulders and waist can be rapidly adjusted to your size. The shape of the air bladder has been designed to ensure perfect buoyancy with a mono cylinder. The anodized light alloy backplate reduces the overall weight of the jacket while guaranteeing

stability and safety in use. The special cylinder rest in thermoplastic rubber integrated with the back of the jacket guarantees the positioning of the tank for optimum trim. The shoulder straps and back cover are made with an air-net material to enhance comfort and improve water drainage. The back cover is equipped with a special pocket designed to house the decompression buoy. The weight pocket system are not included and available separately.

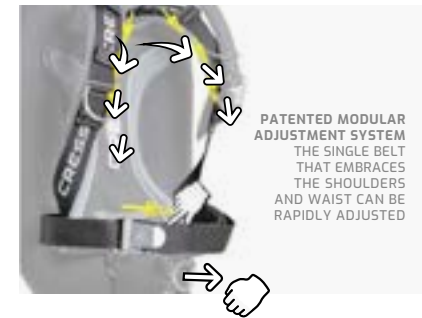

PATENTED MODULAR ADJUSTMENT SYSTEM THE SINGLE BELT THAT EMBRACES THE SHOULDERS AND WAIST CAN BE RAPIDLY ADJUSTED

CODE	PRODUCT	CASE PACK
IC790000	AQUAWING BCD XS/XL	1

## ACCESSORIES

CODE	PRODUCT
IC760099	TANK STRAP WEIGHT POCKET
I2790400	AQUAWING PLATE WEIGHT 2.5 kg
I2790300	AQUAWING WEIGHT POCKET
I2790200	AQUAWING MODULAR SYSTEM KIT

## SPARE PARTS

CODE	PRODUCT
I2750275	O-RING MAINTENANCE KIT for BCD INFLATOR FLAT



INTEGRATED CYLINDER REST



AIR-NET MATERIAL



BACK COVER POCKET



BACK WEIGHT POCKETS INCLUDED



# COMMANDER EVOLUTION

## BACK INFLATION INTEGRATED WEIGHT POCKETS



### TECHNICAL FEATURES

- Air cell material: 420 denier nylon
- Integrated Cressi Flat-lock Aid Weight System
- 2 rear ballast pouches
- 3 pressure relief valves
- Four 50 mm aluminum D-rings on the shoulder straps
- Four 25 mm stainless steel D-rings (2 on the pockets and 2 on the lower part of the harness)
- Ultralight rigid back plate with carrying handle.
- Next-generation anatomical inflator with hose retainer
- Multipurpose zip pockets
- 50 mm quick-release buckled shoulder straps
- Multipurpose zip pockets

### BUOYANCY

SIZE	NEWTON	KG	LB
XS	130	13.3	29.2
S	130	13.3	29.2
M	190	19.4	42.7
L	220	22.4	49.5
XL	220	22.4	49.5

### PRODUCT WEIGHT

SIZE	KG	LB
XS	3.05	6.70
S	3.10	6.83
M	3.20	7.05
L	3.30	7.27
XL	3.40	7.50

It is an impressively light high-buoyancy rear-mounted BCD, anatomically designed for maximum comfort and wearability. Its main features are its detachable harness and air cell. The rear-mounted air cell interferes neither with the main underwater component nor the adjustment straps, not even when it is inflated to the maximum. This means extra freedom of movement and buoyancy for the diver. The special air cell compression strap guarantees extra quick deflation and volume control. The ultralight rigid back plate with its integrated carrying

handle ensures optimal stability. Its integrated Cressi Flat-Lock-Aid weight system makes it extra easy to release the pockets and rear ballast bags (attached to the tank-block band). Accessories include four 50mm shoulder aluminum D-rings and four 25mm aluminum D-rings (of which two on the pockets and two on the lower part of the harness). There are 3 pressure relief valves: one on the upper part of the hose, one reel-operated valve on the right-hand side of the shoulder, and a third on the lower right-hand side of the air cell.



CODE	SIZE	CASE PACK
IC771000	XS	1
IC771001	S	1
IC771002	M	1
IC771003	L	1
IC771004	XL	1

### OPTIONAL ACCESSORIES

CODE	PRODUCT
IZ750094	INTEGRATED FLAT-LOCK WEIGHT POCKET 10 LB
IC760099	TANK STRAP WEIGHT POCKET

### SPARE PARTS

CODE	PRODUCT
IZ750275	O-RING MAINTENANCE KIT for BCD INFLATOR FLAT



# EMPEROR

NEW  
2024

HIGH VOLUME HYBRID  
INFLATION B.C.D.



50mm  
PIVOTING  
BUCKLES



## TECHNICAL FEATURES

- 50 mm swinging buckles
- Lower shoulder strap connected to a ring for optimal rotation and adjustability.
- Ventral harness with SPWB
- Integrated Flat Lock ballast system
- Customisation of weight distribution

## BUOYANCY

SIZE	NEWTON	KG	LB
S	140	14,2	31 1/4
M	160	16,3	35 7/8
L	210	21,4	47 1/8



BCD with an exclusive design and technical solutions that ensure perfect buoyancy and a snug profile. The shoulder straps have 50 mm pivoting buckles, offering maximum comfort during movement. The lower strap of the shoulder strap is connected to a ring that allows rotation and thus maximum adaptability. The inside of the jacket is entirely made of air-net material, with extra padding to increase comfort and promote water drainage. The 2-piece

waistband system uses the new patented SPWB (self-pivoting waistband) system. The backrest, which is semi-rigid, soft, and padded, allows it to be folded and carried compactly. The Integrated Flat Lock ballast system makes it much easier to remove the weight pockets. There are 2 pockets on the back for weight distribution and always achieve the optimum buoyancy position.

CODE	SIZE	CASE PACK
IC775002	EMPEROR (S)	1
IC775003	EMPEROR (M)	1
IC775004	EMPEROR (L)	1
IC775005	EMPEROR (XL)	1

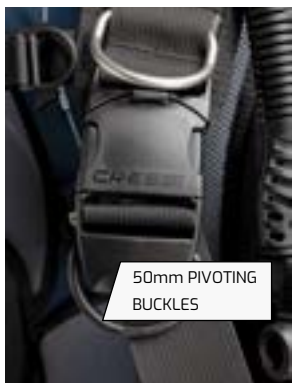

50mm PIVOTING  
BUCKLES



FULLY ADJUSTABLE  
WAIST HARNESS



STEEL D-RINGS



BACK WEIGHTPOCKETS



# ELETTRA

SPECIFICALLY DESIGNED  
FOR WOMEN



The jacket has been conceived to adapt to the female anatomy. The exclusive design and technical features provide perfect buoyancy with a close-fitting profile. The 40 mm buckles (shoulder-waist) adapt perfectly to the female anatomy. The lower band of the shoulder strap is anchored to a ring to ensure rotation and therefore maximum adaptability to the female anatomy. The internal part is fully lined with air-net material, with thicker padding to increase comfort

and improve water drainage. The two-piece waistband uses the new patented SPWB (Self Pivoting Waist Band) system. The soft and padded semi-rigid back plate permits the BCD to be folded and transported with the minimum possible volume. The Cressi Flat Lock integrated ballast system makes the extraction of the weight bags particularly easy. The jacket's two integrated cylinder supports improve the diver's trim.



CODE	SIZE	CASE PACK
IC774001	XS	1
IC774002	S	1
IC774003	M	1
IC774004	L	1

#### ACCESSORIES

CODE	PRODUCT
I2750094	INTEGRATED FLAT-LOCK WEIGHT POCKET 10 LB
IC760099	TANK STRAP WEIGHT POCKET

#### SPARE PARTS

CODE	PRODUCT
I2750275	O-RING MAINTENANCE KIT for BCD INFLATOR FLAT

40mm BUCKLES



FULLY ADJUSTABLE WAIST HARNESS  
SELF PIVOTING WAIST BAND



STEEL D-RINGS



#### TECHNICAL FEATURES

- Conceived for the female anatomy
- Air bladder: 420 Denier nylon
- Pockets and shoulder straps: Cordura 1500 Denier nylon
- Self Pivoting Waist Band
- Integrated Cressi Flat-Lock Aid Weight System
- 2 zip-up pockets for accessories
- Semi-rigid harness
- 6 stainless steel D-rings
- 3 discharge and overpressure air valves



FLAT LOCK  
SYSTEM



# SCORPION

BACK INFLATION  
VERTICAL INTEGRATED WEIGHT POCKETS



SCUBALAB  
**BEST BUY**  
2020

The jacket is an impressively light high buoyancy rear-mounted BCD, anatomically designed for maximum comfort and wearability. Its main features are its detachable harness and air cell. The main innovation is the orientation of the ballast pockets. Instead of being horizontal and taking up the space intended for the pockets, they are located vertically in line with the tank, behind the pockets, and perfectly integrated into the profile of the jacket. Having them aligned with the body and perfectly located on both sides will dramatically increase buoyancy control, increasing stability and facilitating any movement.

The rear-mounted air cell interferes neither with the main underwater component nor with the adjustment straps, not even when it is inflated to the maximum: this means extra freedom of movement and buoyancy for the diver.

The special air cell compression strap guarantees extra quick deflation and volume control. The ultralight semi-rigid harness ensures optimal stability and high comfort with its air-net fabric. Its integrated Cressi Flat-Lock-Aid Weight system makes it extra easy to release the pockets.



CODE	SIZE	CASE PACK
IC770000	XS	1
IC770001	S	1
IC770002	M	1
IC770003	L	1
IC770004	XL	1

ACCESSORIES

CODE	PRODUCT
IZ750094	INTEGRATED FLAT-LOCK WEIGHT POCKET 10 LB
IC760099	TANK STRAP WEIGHT POCKET

SPARE PARTS

CODE	PRODUCT
IZ750275	O-RING MAINTENANCE KIT for BCD INFLATOR FLAT

TECHNICAL FEATURES

- Development of rear-mounted air cell
- Integrated flat-lock weight pocket system in vertical position
- Air cell fabric: 420 denier nylon
- 3 pressure relief valves
- 2 50 mm aluminum D-rings on the shoulder straps
- 2 25 mm aluminum D-rings on the pockets
- Ultralight semi-rigid harness
- Next-generation anatomical inflator with hose retainer
- Multipurpose zip pockets
- 40 mm quick-release buckles on shoulder straps
- Side adjustable lumbar flaps

BUOYANCY

SIZE	NEWTON	KG	LB
XS	130	13.3	29.2
S	130	13.3	29.2
M	150	15.3	33.7
L	150	15.3	33.7
XL	150	15.3	33.7



VERTICAL FLAT LOCK



ZIPPED POCKETS



REAR ATTACHMENT



ALU D-RINGS // 40mm BUCKLES



# TRAVELIGHT™

FLEXIBLE PADDED BACK INTEGRATED WEIGHT POCKETS



PINK

BLUE



2.50 kg · 5.5 lb  
SIZE M

## TECHNICAL FEATURES

- 2 zip pockets
- 2 rear weight carrying pockets
- Soft, padded back with double strap for fixing the tank
- 3 discharge and pressure valves
- Semi-rigid backplate makes it fully foldable

## BUOYANCY

SIZE	NEWTON	KG	LB
XS	60	6.1	13.5
S	80	8.2	18.0
M	90	9.2	20.2
L	130	13.3	29.2
XL	160	16.3	36.0



FAST FOLDING SYSTEM



LIGHT ALLOY D-RINGS

40mm BUCKLES



ZIPPED POCKETS

It is designed as a super-serious travel BCD. The basic design was drawn from the Cressi Flex BCD the first worldwide travel BCD in the Scuba Industry. The dry weight of travel light is only 2.7 kg | 6 lb. The back is amply padded, for a comfortable fit. It uses the Cressi's Lock-Aid Integrated Weight System and can store 9 kg | 20 lb in the front pockets and a further

4.5 kg | 10 lb in the no-detachable back pockets. With an eye on keeping the weight down, all of those D-rings are made from a lightweight material. The air cell inflates away from the body which avoids constricting the diver.



FLAT LOCK SYSTEM



CODE	COLOR	SIZE
IC740600	BLUE	XS
IC740601	BLUE	S
IC740602	BLUE	M
IC740603	BLUE	L
IC740604	BLUE	XL
IC740620	PINK	XS
IC740621	PINK	S
IC740622	PINK	M

## ACCESSORIES

CODE	PRODUCT
IZ750094	INTEGRATED FLAT-LOCK WEIGHT POCKET 10 LB
IC760099	TANK STRAP WEIGHT POCKET

## SPARE PARTS

CODE	PRODUCT
IZ750080	O-RING KIT for BCD INFLATOR



# AQUARIDE

SEMI-CLASSIC STRUCTURED INTEGRATED WEIGHT POCKETS



It is a semi-classic structured BCD with a special feature: it has adjustable shoulder straps that aren't restricted by the air cell, improving the grip on the tank and improving comfort. Thanks to their anatomical, preformed profile, they are much easier to put on and make resting the tank more comfortable on the shoulders. It features the Flat Lock Aid System of integrated weight. It is very effective and comfortable thanks to its extremely flat profile and the easy and intuitive arrangement of the pockets. Finally, the anatomical control has a hose retainer, making all inflation and deflation

operations very easy and intuitive. Fully redesigned in 2015, the Aquaride offers the best you really need for your dive experience. It has been considered the only BCD in his test group to earn solid very good scores in all performance categories for 2 years. Passed and placed first in all tests thanks to the size range, efficient adjustments, and its super-stability at depth. In the final countdown for Testers' Choice, it earned almost twice as many five points as its closest competitor.

CODE	SIZE	CASE PACK
IC740800	XS	1
IC740801	S	1
IC740802	M	1
IC740803	L	1
IC740804	XL	1

ACCESSORIES

CODE	PRODUCT
I2750094	INTEGRATED FLAT-LOCK WEIGHT POCKET 10 LB
IC760099	TANK STRAP WEIGHT POCKET

SPARE PARTS

CODE	PRODUCT
I2750080	O-RING KIT for BCD INFLATOR

TECHNICAL FEATURES

- Adjustable shoulder straps.
- Superlight rigid backpack with handle.
- Next-generation anatomical inflator with hose retainer.
- Expandable sundries pocket with zip closure.
- Quick-attach rear weight pockets (capacity 2 kg · 5 lb).
- 3 purge and overpressure air valves.

BUOYANCY

SIZE	NEWTON	KG	LB
XS	80	8.2	18.0
S	90	9.2	20.2
M	130	13.3	29.2
L	160	16.3	36.0
XL	190	19.4	42.7

BACK WEIGHTS POCKETS



50mm BUCKLES



STEEL D-RINGS



ZIPPED POCKETS



# SOLID PLUS

NEW 2024

WEIGHT INTEGRATED B.C.D. FOR DIVE CENTERS

## TECHNICAL FEATURES

- Quick locking system
- Enhanced visibility
- Integrated whistle
- Optimal fit and size indication
- Made of 500-denier Cordura and 420-denier nylon for strength and durability

## BUOYANCY

SIZE	NEWTON	KG	POUNDS
XXS	80	8,1	17 7/8
XS	120	12,2	26 7/8
S	140	14,2	31 1/4
M	160	16,3	35 7/8
L	190	19,3	42 1/2
XL	220	22,4	49 3/8
XXL	220	22,4	49 3/8



NEW

QUICK LOCK WEIGHT



FLAT LOCK SYSTEM

The Solid Plus is an evolution of the Solid model to offer greater safety and convenience for the dive center and divers. Equipped with the new Quick Lock System weight release system, it allows quick and safe one-handed release of ballasts. Made of 500-denier Cordura externally and 420-denier nylon internally, it offers strength and durability, and the back features a colored band to increase visibility in the water and protect the jacket from abrasion.

Equipped with a super-light rigid back with carrying handle, whistle integrated into the sternal buckle, three exhaust-suppression valves and practical technopolymer D-rings; Adjustable shoulder straps with 50 mm buckles ensure an optimal fit and clearly display the jacket size, offering great convenience in rental activities. Solid Plus is the Cressi proposal for top dive centers looking for a superior jacket in rental and school activities.



GAUGE AND OCTOPUS HOLDER

CODE	SIZE	CASE PACK
JIC741601	XS	1
JIC741602	S	1
JIC741603	M	1
JIC741604	L	1
JIC741605	XL	1
JIC741606	2XL	1



HIGH VISIBILITY BACK PAD



50mm BUCKLES



QUICK LOCK WEIGHT



ULTRA RESISTANT MATERIALS





# PATROL

BACK INFLATION | INTEGRATED WEIGHT POCKETS

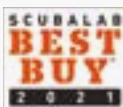

## TECHNICAL FEATURES

- Back inflation bcd
- Ultralight rigid back plate
- Soft, padded back

## BUOYANCY

SIZE	NEWTON	KG	LB
XS	130	13.3	29.2
S	130	13.3	29.2
M	190	19.4	42.7
L	220	22.4	49.5
XL	200	22.4	49.5

2024 - CATALOG

The Patrol BC is an impressively lightweight, rear inflation BC that is anatomically designed for maximum comfort and durability. The special air cell compression strap guarantees extra quick deflation and volume control. The ultralight rigid back plate with its integrated carrying handle ensures optimal stability. The Patrol also features Cressi's Flat-Lock-Aid integrated weight system that makes it easy to

release the pockets. There are 3 pressure relief valves: one on the upper part of the hose, one valve on the right-hand side of the shoulder and a third on the lower right-hand side of the air cell. The Patrol also features plastic D-rings to help reduce weight and the shoulder and the waist harness is fully adjustable to one full size up or down from the stated size.



CODE	SIZE	CASE PACK	DEALER	ASSOCIATE	MASTER	PARTNER	MAP
IC741600	XS	1	230.71	223.79	216.87	209.95	399.95
IC741601	S	1	230.71	223.79	216.87	209.95	399.95
IC741602	M	1	230.71	223.79	216.87	209.95	399.95
IC741603	L	1	230.71	223.79	216.87	209.95	399.95
IC741604	XL	1	230.71	223.79	216.87	209.95	399.95

## ACCESSORIES

CODE	PRODUCT	DEALER	ASSOCIATE	MASTER	PARTNER	SP
I2750094	INTEGRATED FLAT-LOCK WEIGHT POCKET 10 LB	21.37	20.73	20.09	19.45	34.95
IC760099	TANK STRAP WEIGHT POCKET	10.93	10.60	10.27	9.95	21.95

## SPARE PARTS

CODE	PRODUCT	DEALER	ASSOCIATE	MASTER	PARTNER
I2750275	O-RING MAINTENANCE KIT for BCD INFLATOR FLAT	7.00	6.65	6.30	5.95



BACK WEIGHT POCKETS OPTIONAL



FLAT LOCK SYSTEM



40mm BUCKLES



FULLY ADJUSTABLE SHOULDER HARNESS



HIDEAWAY POCKET



FULLY ADJUSTABLE WAIST HARNESS



CRESSI

# START PRO 2.0

JACKET-STYLE | GRAVITY WEIGHT POCKETS



Designed primarily as a rental BC for resorts and dive schools, the Start Pro gives students and customers the stability of a jacket-style BCD and the convenience of weight integration. Diver operators will appreciate

its bullet-proof construction using Cordura® 1000 and 500 Denier nylon and large, easily seen size markings on the shoulder.

## TECHNICAL FEATURES

- Ultra-durable construction
- Integrated weight pockets use rugged quick-release buckles
- 2 Large pockets cargo pockets with YKK zipper closure
- Rigid padded backpack and carry handle
- 3 exhaust valves for buoyancy adjustment in any position
- 25 mm technopolymer D-rings available in the shoulder straps
- 4 available D-rings: 1 above, 1 at the bottom of each pocket
- Size clearly visible on the shoulder strap
- Cordura 500 Denier fabric (exterior and interior part)
- 2 large accessory holder zip pockets
- Light-weight, rigid backplate with carry handle
- 3 overpressure dump valves
- 25 mm technopolymer D-rings on the pockets
- High-visible size on shoulder straps
- 50 mm shoulder straps with buckles

## BUOYANCY

SIZE	NEWTON	KG	LB
XXS	70	7.14	15.7
XS	130	13.3	29.2
S	140	14.3	31.5
M	150	15.3	33.7
L	170	17.3	38.2
XL	200	20.4	45.0

CODE	SIZE	CASE PACK	DEALER	ASSOCIATE	MASTER	PARTNER	MAP
IC721905	2XS	1	219.73	213.14	206.55	199.95	349.95
IC721900	XS	1	219.73	213.14	206.55	199.95	349.95
IC721901	S	1	219.73	213.14	206.55	199.95	349.95
IC721902	M	1	219.73	213.14	206.55	199.95	349.95
IC721903	L	1	219.73	213.14	206.55	199.95	349.95
IC721904	XL	1	219.73	213.14	206.55	199.95	349.95
<b>NEW</b> IC721906	2XL	1	219.73	213.14	206.55	199.95	349.95

## ACCESSORIES

CODE	PRODUCT	DEALER	ASSOCIATE	MASTER	PARTNER	SP
IZ750094	INTEGRATED FLAT-LOCK WEIGHT POCKET 10 LB	21.37	20.73	20.09	19.45	34.95
IC760099	TANK STRAP WEIGHT POCKET	10.93	10.60	10.27	9.95	21.95

## SPARE PARTS

CODE	PRODUCT	DEALER	ASSOCIATE	MASTER	PARTNER
IZ750275	O-RING MAINTENANCE KIT for BCD INFLATOR FLAT	7.00	6.65	6.30	5.95



FIXED GRAVITY POCKET SYSTEM



GAUGE AND OCTOPUS HOLDER



ENGINEERED PLASTIC D-RINGS // 50 mm BUCKLES



ZIPPED POCKETS



# SOLID

JACKET-STYLE | 500D/420D NYLON



## TECHNICAL FEATURES

- Exterior: Cordura 500D nylon
- Interior: Cordura 420D nylon
- 2 large accessory holder zip pockets
- Light-weight, rigid backplate with carry handle
- 3 overpressure dump valves
- High-visible size on the shoulder strap
- 50 mm shoulder straps with buckles

## BUOYANCY

SIZE	NEWTON	KG	LB
XXS	80	8.2	18.0
XS	120	12.2	27.0
S	140	14.3	31.5
M	160	16.3	36.0
L	190	19.4	42.7
XL	220	22.4	49.5

## GAUGE AND OCTOPUS HOLDER



Good buoyancy, ideal for scuba diving schools and equipment rental centres. It features a coloured reinforcement band in the upper part of the back, at neck level, to enhance visibility in the water and protect the jacket from the abrasive action of the first stage. The sternal attachment is closed by a buckle which also serves as a safety whistle.



CODE	SIZE	CASE PACK
JIC741705	2XS	1
JIC741700	XS	1
JIC741701	S	1
JIC741702	M	1
JIC741703	L	1
JIC741704	XL	1
<b>NEW</b> JIC741706	2XL	1

## ACCESSORIES

CODE	PRODUCT
IC760099	TANK STRAP WEIGHT POCKET

## SPARE PARTS

CODE	PRODUCT
IZ750275	O-RING MAINTENANCE KIT for BCD INFLATOR FLAT

HIGH VISIBILITY BACK PAD



50mm BUCKLES



ZIPPED POCKETS



ULTRA RESISTANT MATERIALS





# START

JACKET-STYLE | 1000D/500D NYLON



## TECHNICAL FEATURES

- Ultra-durable construction
- Ideal for frequent use
- 2 large pockets cargo pockets with velcro closure
- Rigid padded backpack and carry handle
- 3 exhaust valves for buoyancy
- Adjustment in any position
- 4 Available D-rings: 1 above, 1 at the bottom of each pocket
- Size clearly visible on the shoulder strap

## BUOYANCY

SIZE	NEWTON	KG	LB
XS	130	13.3	29.2
S	140	14.3	31.5
M	150	15.3	33.7
L	170	17.3	38.2
XL	200	20.4	45.0

Designed primarily as a rental BCD for resorts and dive schools, the Start is a simple, functional jacket-style BCD without weight integration. Diver operators will appreciate its bullet-proof construction using Cordura Nylon fabric and large, easily seen size markings on the shoulder. It's designed for heavy-duty use, robust and reliable.

CODE	SIZE	CASE PACK
IC721700	XS	1
IC721701	S	1
IC721702	M	1
IC721703	L	1
IC721704	XL	1

## ACCESSORIES

CODE	PRODUCT
IC760099	TANK STRAP WEIGHT POCKET

## SPARE PARTS

CODE	PRODUCT
IZ750275	O-RING MAINTENANCE KIT for BCD INFLATOR FLAT

GAUGE AND OCTOPUS HOLDER



SIZE ON SHOULDER PAD



COMPACT TANK BACKPACK



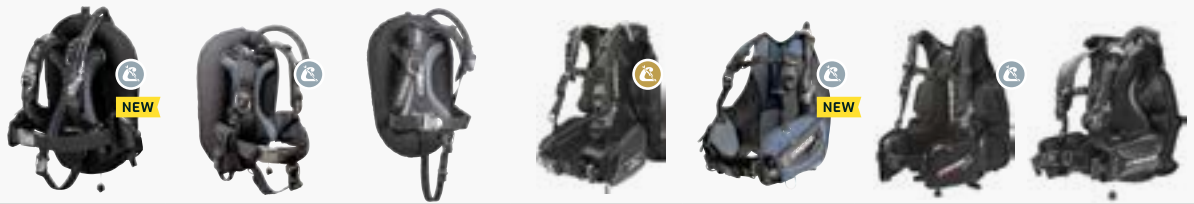

	AQUAWING MAX	AQUAWING PLUS	AQUAWING	COmMAnDER EVO	EMPEROR	SCORPION	PATROL
<b>TYPE OF AIR CELL MATERIAL</b>	Back Cell Nylon 210 D Cordura 1500 D	Back Cell Nylon 210 D Cordura 1500 D	Back Cell Nylon 210 D Cordura 1500 D	Back Cell Nylon 420 D	Standard Nylon 420 D	Back cell Nylon 420 D	Back cell Nylon 420 D
<b>BUOYANCY IN NEWTON</b>							
<b>XXS</b>	ONE-SIZE XS-XL	ONE-SIZE XS-XL	ONE-SIZE XS-XL	-	-	-	-
<b>XS</b>				130	-	130	130
<b>S</b>				130	140	130	130
<b>M</b>				190	160	150	190
<b>L</b>				170	120	120	220
<b>XL</b>							220
<b>XXL</b>							-
<b>TYPE OF BACKPLATE / CYLINDER FIXING</b>	Rigid / Double strap	Rigid / Double strap	Rigid / Double strap	Rigid / Single strap	Soft / Double strap	Soft / Double strap	Rigid / Single strap
<b>COMPATIBLE CYLINDERS LITRES - DIAMETER mm</b>	MONO 10/12/15/18 - 171/203/216	MONO 10/12/15/18 - 171/203/216	MONO 10/12/15/18 - 171/203/216	MONO 10/12/15/18 - 171/203/216	MONO 10/12/15/18 - 171/203/216	MONO 10/12/15/18 - 171/203/216	MONO 10/12/15/18 - 171/203/216
<b>INTEGRATED WEIGHT POCKETS - MAX KG FOR POCKET</b>	Fixed gravity pocket - 3+3	Fixed gravity pocket - 3+3	NO	Flat lock aid - 4,5+4,5	Flat lock aid - 4,5+4,5	Flat lock aid - 4,5+4,5	Flat lock aid - 4,5+4,5
<b>ABDOMINAL ADJUSTMENT</b>	Buckle	Buckle	Buckle	Buckle	Buckle + SPWB (self pivoting waistband) "B"	Buckle	Buckle + LAS (length adj. system)
<b>STERNAL ADJUSTMENT</b>	No	No	No	Fixed	Movable	Movable	Fixed
<b>SHOULDER STRAP ADJUSTMENT</b>	MAS (Modular Adjustment System)	MAS (Modular Adjustment System)	MAS (Modular Adjustment System)	Standard	Standard + Pivoting Buckle	Standard	Standard + LAS (length adj. system)
<b>QUICK DUMP AND OVER-PRESSURE VALVES</b>							
<b>N°</b>	1	1	1	2	2	2	2
<b>DISCHARGE KNOB POSITION</b>	At the back, lower left area	At the back, lower left area	At the back, lower left area	At the back, lower right area At the front, upper right Area	At the back, lower right area At the front, upper right Area	At the back, lower right area At the front, upper right Area	At the back, lower right area At the front, upper right Area
<b>TOTAL DUMP VALVES</b>	3	3	3	4	4	4	4
<b>N° CHARGE VALVES</b>	2	2	2	2	2	2	2
<b>TYPE OF CONTROL UNIT</b>	FLAT	FLAT	FLAT	FLAT	FLAT	FLAT	FLAT
<b>N° OF POCKETS</b>	-	-	-	2	2	2	1
<b>N° OF BACK POCKETS</b>	2	2	2	2	-	-	-
<b>N° OF "D" RINGS</b>	4	4	2	10	6	4	6
<b>B.C.D. WEIGHT &amp; TOTAL BALLAST THAT CAN BE USED (KG)</b>							
<b>XXS</b>	ONE-SIZE XS-XL	ONE-SIZE XS-XL	ONE-SIZE XS-XL	-	-	-	-
<b>XS</b>				3,1 - 14	-	2,4 - 11	2,6 - 9
<b>S</b>				3,15 - 14	n/a	2,45 - 11	2,6 - 9
<b>M</b>				3,25 - 14	3,8 - 14	2,5 - 13	2,75 - 9
<b>L</b>				3,4 - 14	n/a	2,6 - 13	2,9 - 9
<b>XL</b>				3,45 - 14	n/a	2,65 - 13	2,9 - 9
<b>XXL</b>							-
<b>WEARABILITY: CHEST (CM) - WAIST (CM) - WEIGHT (KG)</b>							
<b>XXS</b>	ONE-SIZE XS-XL	ONE-SIZE XS-XL	ONE-SIZE XS-XL	-	-	-	-
<b>XS</b>				80/90 75/90 55/65	-	80/90 75/90 55/65	80/90 75/90 55/65
<b>S</b>				90/100 85/95 63/78	90/100 85/95 63/78	90/100 85/95 63/78	90/100 85/95 63/78
<b>M</b>				100/110 95/105 75/85	100/110 95/105 75/85	100/110 95/105 75/85	100/110 95/105 75/85
<b>L</b>				105/115 100/110 80/100	105/115 100/110 80/100	105/115 100/110 80/100	105/115 100/110 80/100
<b>XL</b>				115/125 110/120 110/120	115/125 110/120 110/120	115/125 110/120 110/120	115/125 110/120 110/120
<b>XXL</b>							-



	AQUARIDE	ELETTRA	TRAVELIGHT	START PRO	START	SOLID PLUS	SOLID	
<b>TYPE OF AIR CELL MATERIAL</b>	Standard Nylon 420 D	Standard Nylon 420 D	Standard Nylon 210 D	Standard Cordura 500 D	Standard Cordura 500 D	Standard Cordura 500 D	Standard Cordura 500 D	
<b>BUOYANCY IN NEWTON</b>								
<b>XXS</b>	-	-	-	70	-	80	80	
<b>XS</b>	80	100	60	130	130	120	120	
<b>S</b>	90	100	80	140	140	140	140	
<b>M</b>	130	140	90	150	150	160	160	
<b>L</b>	160	160	130	170	170	190	190	
<b>XL</b>	190	-	160	200	200	220	220	
<b>XXL</b>	-	-	-	200	-	220	220	
<b>TYPE OF BACKPLATE / CYLINDER FIXING</b>	Rigid / Single strap	Soft / Double strap	Soft / Double strap	Rigid / Single strap	Rigid / Single strap	Rigid / Single strap	Rigid / Single strap	
<b>COMPATIBLE CYLINDERS LITRES - DIAMETER mm</b>	MONO 10/12/15/18 - 171/203/216	MONO 10/12/15/18 - 171/203/216	MONO 10/12/15/18 - 171/203/216	MONO 10/12/15/18 - 171/203/216	MONO 10/12/15/18 - 171/203/216	MONO 10/12/15/18 - 171/203/216	MONO 10/12/15/18 - 171/203/216	
<b>INTEGRATED WEIGHT POCKETS - MAX KG FOR POCKET</b>	Flat lock aid - 4.5+4.5	Flat lock aid - 4.5+4.5	Flat lock aid - 4.5+4.5	Fixed gravity pocket - 2+2 (xxs, xs, s) / 3+3 (m, l, xl)	NO	Quick Lock System N/A (xxs, xs, s) / 4.5+4.5 (m, l, xl, xxl)	NO	
<b>ABDOMINAL ADJUSTMENT</b>	Standard waist band + buckle	Buckle + SPWB (self pivoting waistband) "B"	Standard waist band + buckle	Standard waist band + buckle	Standard waist band + buckle	Standard waist band + buckle	Standard waist band + buckle	
<b>STERNAL ADJUSTMENT</b>	Fixed	Movable	Fixed	Fixed	Fixed	Fixed	Fixed	
<b>SHOULDER STRAP ADJUSTMENT</b>	Standard	Standard	Standard	Standard	Standard	Standard	Standard	
<b>QUICK DUMP AND OVER-PRESSURE VALVES</b>								
<b>N°</b>	2	2	2	2	2	2	2	
<b>DISCHARGE KNOB POSITION</b>	At the back, lower right area At the front, upper right Area	At the back, lower right area At the front, upper right Area	At the front, lower right area At the front, upper right Area	At the back, lower right area At the front, upper right Area	At the back, lower right area At the front, upper right Area	At the back, lower right area At the front, upper right Area	At the back, lower right area At the front, upper right Area	
<b>TOTAL DUMP VALVES</b>	4	4	4	4	4	4	4	
<b>N° CHARGE VALVES</b>	2	2	2	2	2	2	2	
<b>TYPE OF CONTROL UNIT</b>	FLAT	FLAT	FLAT	FLAT	FLAT	FLAT	FLAT	
<b>N° OF POCKETS</b>	2	2	2	2	2	2	2	
<b>N° OF BACK POCKETS</b>	2	-	2	-	-	-	-	
<b>N° OF "D" RINGS</b>	8	6	6	6	4	3	3	
<b>B.C.D.W WEIGHT &amp; TOTAL BALLAST THAT CAN BE USED (KG)</b>								
<b>XXS</b>	-	-	-	2.4 - 4	-	n/a	2.1 - NO	
<b>XS</b>	3.0 - 14	2.95 - 9	2.4 - 14	2.5 - 4	2.4 - NO	n/a	2.2 - NO	
<b>S</b>	3.1 - 14	3 - 9	2.4 - 14	2.5 - 4	2.5 - NO	n/a	2.25 - NO	
<b>M</b>	3.2 - 14	3.1 - 9	2.5 - 14	2.75 - 6	2.6 - NO	2.9 - 9	2.3 - NO	
<b>L</b>	3.3 - 14	3.15 - 9	2.5 - 14	2.8 - 6	2.7 - NO	n/a - 9	2.35 - NO	
<b>XL</b>	3.4 - 14	-	2.6 - 14	2.9 - 6	2.8 - NO	n/a - 9	2.4 - NO	
<b>XXL</b>	-	-	-	2.9	-	n/a - 9	n/a	
<b>WEARABILITY: CHEST (CM) - WAIST (CM) - WEIGHT (KG)</b>								
<b>XXS</b>	-	-	-	70/85 70/80 48/60	-	70/85 70/80 48/60	70/85 70/80 48/60	
<b>XS</b>	80/90 75/90 55/65	80/90 75/90 55/65	80/90 75/90 55/65	80/90 75/90 55/65	80/90 75/90 55/65	80/90 75/90 55/65	80/90 75/90 55/65	
<b>S</b>	90/100 85/95 63/78	90/100 85/95 63/78	90/100 85/95 63/78	90/100 85/95 63/78	90/100 85/95 63/78	90/100 85/95 63/78	90/100 85/95 63/78	
<b>M</b>	100/110 95/105 75/85	100/110 95/105 75/85	100/110 95/105 75/85	100/110 95/105 75/85	100/110 95/105 75/85	100/110 95/105 75/85	100/110 95/105 75/85	
<b>L</b>	105/115 100/110 80/100	105/115 100/110 80/100	105/115 100/110 80/100	105/115 100/110 80/100	105/115 100/110 80/100	105/115 100/110 80/100	105/115 100/110 80/100	
<b>XL</b>	115/125 110/120 110/120	-	115/125 110/120 110/120	115/125 110/120 110/120	115/125 110/120 110/120	115/125 110/120 110/120	115/125 110/120 110/120	
<b>XXL</b>	-	-	-	125/130 120/130 120/125	-	125/130 120/130 120/125	125/130 120/130 120/125	





# SCUBA PACKAGES

SCUBA



# AQUAWING DIGI PACK

NEW 2024



### ITEMS INCLUDED

- B.C.D. AQUAWING
- REGULATOR MC9 / COMPACT - BLACK (INT)
- OCTOPUS COMPACT
- DIGI 2 CONSOLE

### CODE

IV790220

\*This offer cannot be used in conjunction with any other promotion or offer | We reserve the right to discontinue or alter the terms of these offers at any time | No product substitution | Minimum quantity 2 packages.

# AQUAWING MINI PACK

NEW 2024



### ITEMS INCLUDED

- B.C.D. AQUAWING
- REGULATOR MC9 / COMPACT - BLACK (INT)
- OCTOPUS COMPACT
- MINI SPG

### CODE

IV790210

\*This offer cannot be used in conjunction with any other promotion or offer | We reserve the right to discontinue or alter the terms of these offers at any time | No product substitution | Minimum quantity 2 packages.



# ELETTRA LADY PACKAGE

NEW 2024



CODE	SIZE
IY774001	XS
IY774002	S
IY774003	M
IY774004	L

### ITEMS INCLUDED

- B.C.D. ELETTRA
- REGULATOR MC9 / COMPACT (INT) - WHITE
- OCTOPUS COMPACT
- DIVE COMPUTER + PRESSURE GAUGE
- DONATELLO CONSOLE 2



\*This offer cannot be used in conjunction with any other promotion or offer | We reserve the right to discontinue or alter the terms of these offers at any time | No product substitution | Minimum quantity 2 packages.

2024 - CATALOG

# PATROL SCUBAPACK

NEW 2024

IDEAL FOR TRAVEL



CODE	SIZE
IY741611	XS
IY741612	S
IY741613	M
IY741614	L
IY741615	XL



## WITH PIPER

CODE	SIZE
IY741601	XS
IY741602	S
IY741603	M
IY741604	L
IY741605	XL

FOR ADDITIONAL VALUE GET  
**A PIPER**



### ITEMS INCLUDED

- B.C.D. PATROL
- REGULATOR MC9/COMPACT
- OCTOPUS COMPACT
- DIVE COMPUTER + PRESSURE GAUGE
- DONATELLO CONSOLE 2

\* OPTIONAL:  
PIPER ULTRALIGHT REOLLEY



# START-ER PRO PACKAGE



CODE	SIZE
IV722100	2XS
IV722101	XS
IV722102	S
IV722103	M
IV722104	L
IV722105	XL
IV722106	2XL



WITH **DIGI 2**



GET A

MINICONSOLE

OR

**DIGI 2\***

\*ADDITIONAL VALUE

CODE	SIZE
IV722110	2XS
IV722111	XS
IV722112	S
IV722113	M
IV722114	L
IV722115	XL
IV722116	2XL

**ITEMS INCLUDED**

- B.C.D. START PRO
- REGULATOR MC9-5C/COMPACT PRO
- OCTOPUS COMPACT PRO DIVE
- MINICONSOLE OR DIGI 2



\*This offer cannot be used in conjunction with any other promotion or offer | We reserve the right to discontinue or alter the terms of these offers at any time | No product substitution | Minimum quantity 2 packages.





# B.C.D POCKETS & ACCESSORIES

SCUBA





# AQUAWING ACCESSORIES

## AQUAWING INTERNAL WEIGHT POCKET



NEW 2024

CODE  
IZ790300

## AQUAWING WEIGHT POCKET ASSEMBLY



NEW 2024

CODE  
IZ790200

## AQUAWING PLATE WEIGHT

2,5 kg · 5.5 lb

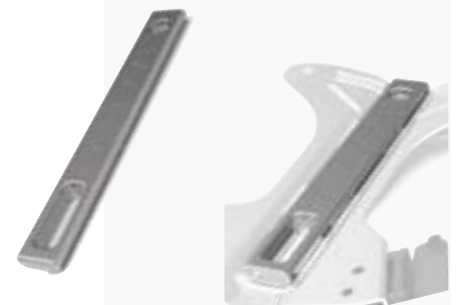

NEW 2024

CODE  
IZ790400

## SPIRAL LANYARD WITH CLIP SNAP

- Extensible coiled lanyard
- Quick-release buckle
- Snap clips for fast attachment
- Ideal for carrying devices like a torch, cameras, writing slates, and others
- Lanyard extends to around 1 m | 3 ft and can support up to 50 kg | 110 lb



NEW 2024

CODE  
JA800100

## SPIRAL LANYARD WITH RING

- Extensible coiled lanyard
- Quick-release buckle
- Snap clips for fast attachment
- Ideal for carrying devices like a torch, cameras, writing slates, and others
- Lanyard extends to around 1 m | 3 ft and can support up to 50 kg | 110 lb



NEW 2024

CODE  
JA800000

## WRITING SLATE

15 x 12,7 cm  
5.9 x 5 in

Must-have communication device while scuba diving, it has plenty of room for taking notes, conversing with your dive buddy, or writing down skill performance when training. Whatever your writing needs are this slate can get it done. It comes with a graphic pencil attached to a high-visible fluorescent lanyard.

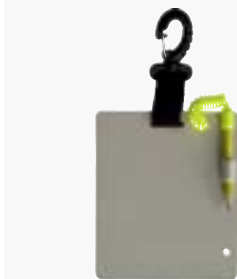

NEW 2024

CODE  
JA700012

## MAGNETIC SHAKER

- Uses a special magnetic system
- The magnet is located inside on either end of the shaker with a ball bearing in between
- Shaking the device moves the ball bearing, creating a loud echo sound underwater
- Great for underwater communication
- A useful underwater safety device



NEW 2024

CODE  
JA702000



# WEIGHT POCKETS

## FLAT-LOCK AID SYSTEM WEIGHT POCKET

4,5 kg · 10lb

**DESCRIPTION:**

Flat Lock Aid System weight pocket for Cressi Jacket

**CHECK COMPATIBILITY**

AT B.C.D.'S COMPARISON TABLE



**CODE**

IZ750094

## TANK STRAP WEIGHT POCKET

**DESCRIPTION:**

Cam Band Trim / Tank Strap Back Weight Pocket



**CODE**

IC760099

# WEIGHT BAG

## LIBRA BALLAST

The Libra is the bag for carrying the ballast needed for your scuba diving equipment. It can carry also the weights used by the freedivers. It is made in strong and resistant Denier fabric, for long-lasting use and for a huge weight. Built rugged, the double webbing encircles the entire bag for added strength and joins to form a padded handle. Double-slider zipper makes it easy to access the main compartment. Personal tag or business card compartment on one side.



**TECHNICAL FEATURES**

- Capacity: 14 liters, 0.5 cu ft
- Dimension: 30.5 x 30.5 x 15.2 cm, 12 x 12 x 6 in



CODE	PRODUCT	CASE PACK
UB500550	LIBRA BALLAST WEIGHT BAG - BLACK	3

# WEIGHT BELTS

Strong, woven nylon weight belt with a stainless steel buckle. The quick-release stainless steel buckle provides an instinctive and rapid emergency release. The buckle tab is very strong and is riveted at both ends.



METAL STAINLESS STEEL BUCKLE

HARD PLASTIC BUCKLE

CODE	PRODUCTS	CASE PACK
UW100000	NYLON WEIGHT BELT w/ METAL BUCKLE - BLACK	10
UW100001	NYLON WEIGHT BELT w/ METAL BUCKLE - NEON YELLOW	10
TA627020	NYLON WEIGHT BELT w/ HARD PLASTIC BUCKLE - BLUE	10

## HOSE CLIP FOR BCD



The Hose Clip is the quick solution for holding the Octopus hose retained to your scuba BCD. It can retain also gauges hoses. It features a double attachment for making a loop with the hose, but that can be easily released in case of an emergency. Thanks to the clip you can attach it to any D-Ring of your scuba BCD.

**CODE**

I2750012

## MULTIPURPOSE HANGER



The multi purpose hanger is water resistant and semi flexible. It allows users to safely place various types of scuba diving equipment, such as regulators, octopus and hoses, vests and/or suits in any environment instead of keeping it in a damp bag or tub. The hanger allows scuba material to drain and dry effectively while saving space.

**CODE**

TA700001

## CUMMERBUND



TYPE A



TYPE B



TYPE C

CODE	PRODUCT
I27501200	CUMMERBUND TYPE A (XS) for S2011T / BACK JAC
I27501201	CUMMERBUND TYPE A (S) for S2011T / BACK JAC
I27501202	CUMMERBUND TYPE A (M) for S2011T / BACK JAC
I27501203	CUMMERBUND TYPE A (L) for S2011T / BACK JAC
I27501204	CUMMERBUND TYPE A (XL) for S2011T / BACK JAC
I27501205	CUMMERBUND TYPE A (2XL) for S2011T / BACK JAC
I27501210	CUMMERBUND TYPE B (XS)
I27501211	CUMMERBUND TYPE B (S)
I27501212	CUMMERBUND TYPE B (M)
I27501213	CUMMERBUND TYPE B (L)
I27501214	CUMMERBUND TYPE B (XL)
I27501215	CUMMERBUND TYPE B (2XL)
I27501219	CUMMERBUND TYPE B (2XS)
I27501220	CUMMERBUND TYPE C (XS) for TRAVELIGHT
I27501221	CUMMERBUND TYPE C (S) for TRAVELIGHT
I27501222	CUMMERBUND TYPE C (M) for TRAVELIGHT
I27501223	CUMMERBUND TYPE C (L) for TRAVELIGHT
I27501224	CUMMERBUND TYPE C (XL) for TRAVELIGHT
I27501225	CUMMERBUND TYPE C (2XL) for TRAVELIGHT

## B.C.D.'S TOOLS



SQUARE DRIVER



SCHRADER VALVE TOOL



SOCKET WRENCH 12mm



COMPASS SPANNER



HEX L-SHAPED KEY 2.5 mm

CODE	PRODUCT
I2750102	SQUARE DRIVER for BCD INFLATOR
I2750103	SCHRADER VALVE TOOL
I2760101	SOCKET WRENCH 12mm for BCD INFLATOR
I2760102	COMPASS SPANNER
I2760103	HEX L-SHAPED KEY 2.5 mm

## MAINTENANCE KIT



CODE	PRODUCT
I2750080	O-RING KIT for BCD INFLATOR
I2750275	O-RING KIT for INFLATOR FLAT

## COMPLETE INFLATOR



CODE	PRODUCT
I2750243	COMPLETE INFLATOR for B.C.D.
I2750273	COMPLETE INFLATOR FLAT

## B.C.D.'S SPARE PARTS



TANK BAND



INFLATION HOSE



RIGID BACKREST



UPPER/LOWER BACK VALVE



COMPLETE POWER INFLATOR

CODE	PRODUCT
I2750039	TANK BAND for BCD
I2750040	STANDARD INFLATION HOSE (69cm - 27.16 in) for BCD INFLATOR
I2750060	COMPLETE RIGID BACKREST for B.C.D.
I2750110	UPPER / LOWER BACK VALVE for BCD (LANYARD 70cm + KNOB)
I2750244	COMPLETE POWER INFLATOR





**FINS**  
SCUBA

# THOR EBS

## ELASTIC BUNGEE SYSTEM



BLACK/SILVER

BLUE



PINK

RED

The new Thor fin has a peculiar and unprecedented structure that combines the two central ribs in high modulus polypropylene, very reactive and a central area of the thermoplastic rubber with a convex section, assembled in a polypropylene blade with two lateral nozzles, located in the area where the flexion starts, release the associated negative forces and allow the use of two high-response ribs. This combination causes a channeling and acceleration of water flow, which stabilizes and increases propulsion at equal effort. The inclination of the blade with respect to the foot pocket has increased by 5% compared to traditional diving models. This angulation provides greater efficiency and a more natural foot position during fluttering. Thor enjoys the exclusive 3-material injection system patented by Cressi, which provides an excellent combination of strength, power, comfort and aesthetics and the optimization of the requirements of each area of the fin. This version of the Thor comes with the EBS system for meet the needs of the most demanding divers, who need a comfortable fastening for their foot but one that is still practical and manageable.

### TECHNICAL FEATURES

- Made using the exclusive 3-material injection system patented by Cressi
- Foot pocket increased by 5%
- Under blade foot pocket
- Very fast transmission of the applied energy
- Great structural rigidity

### FLOW CONVECTION EFFECT

### SPECIAL ARCHED PROFILE

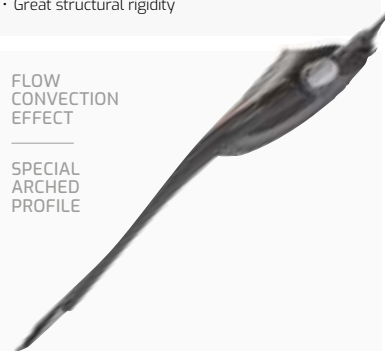

### CRESSI EBS

Wearing fins has never been easier thanks to the special elastic, even with just one hand! The Elastic Bungee Strap holds the fin firmly to the foot and no adjustment is required!



### CRESSI EBS



Cressi has developed this special strap to meet the needs of the most demanding divers, who need a comfortable fastening for their foot but one that is still practical and manageable. Its special amply sized slot makes it very easy to put on, even when wearing thick gloves or three-fingered gloves for winter water. The wrapping section is highly flexible, making adjustments unnecessary, and as a result it's much easier to get all your equipment right in the first few meters of your descent and the fin stays in place against your foot despite the increase in hydrostatic pressure.



CODE	COLOR	SIZE	CASE PACK
BE152036	Blue	XS/S	3
BE152039	Blue	S/M	3
BE152042	Blue	L	3
BE152045	Blue	XL	3
BE154036	Pink	XS/S	3
BE154039	Pink	S/M	3
BE155036	Black/Silver	XS/S	3
BE155039	Black/Silver	S/M	3
BE155042	Black/Silver	L	3
BE155045	Black/Silver	XL	3







CATALOG 2024

OPTIONAL ACCESSORIES

CODE	PRODUCT	SIZE	CASE PACK
BZ150004	EBS FIN STRAP for ARA/FROG/PRO LIGHT/THOR - SHORT FIT	Short Fit (XS/S - S/M)	20
BZ150005	EBS FIN STRAP for ARA/FROG/PRO LIGHT/THOR - REGULAR FIT	Regular Fit (S/M - M/L)	20
BZ150006	EBS FIN STRAP for ARA/FROG/PRO LIGHT/THOR - EXTENDED FIT	Extended Fit (M/L - L/XL)	20

SIZE CONVERSION CHART				
FIN SIZE	EU FOOT SIZE	UK FOOT SIZE	US MEN FOOT SIZE	US WOMEN FOOT SIZE
S/M	36/38	3/5	4/6	5/7
M/L	39/40	6/7.5	7/8.5	8/9.5
L	42/44	8/9.5	9/10.5	10/11.5
XL	45/48	10/12	11/13	12/14

PRODUCT DIMENSION CHART					
A	B	C	D	POCKET HEIGHT	SINGLE FIN WEIGHT
589 mm 23.2 in	206 mm 8.1 in	325 mm 12.7 in	95 mm 3.7 in	83 mm	760 g
629 mm 24.8 in	218 mm 8.6 in	346 mm 13.6 in	100 mm 3.9 in	85 mm	850 g
668 mm 26.3 in	234 mm 9.2 in	368 mm 14.4 in	108 mm 4.2 in	92 mm	1021 g
680 mm 26.8 in	246 mm 9.7 in	390 mm 15.3 in	114 mm 4.5 in	86 mm	1134 g

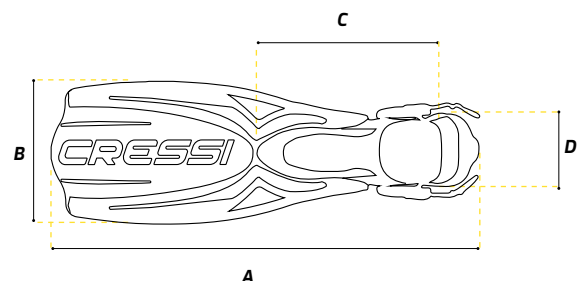

CRESSI

⚠️ FINS COULD COME LABELED WITH EU AND UK SIZES ONLY  
CRESSI'S SIZE CHART TO BE USED AS A REFERENCE ONLY  
USA REV. 06/2023

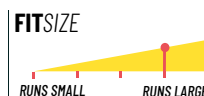

TO MAXIMIZE PERFORMANCE AND COMFORT, WEAR FINN WITH:

		✓	✓
		<small>3 mm - 5 mm - 7 mm</small>	<small>3 mm - 5 mm - 7 mm</small>



# REACTION EBS

## ELASTIC BUNGEE SYSTEM



YELLOW/SILVER



BLUE/AZURE



BLACK/SILVER



WHITE/PINK

Cressi's most technically advanced fin, the Reaction uses a completely new polypropylene blade material that is more reactive, flexible, and trimmer than previous designs. It kicks easily yet powerfully and is suitable for divers of every experience level. The long blade efficiently transfers energy from the computer-designed foot pocket, and like other Cressi fins, the blade extends from the top of the foot pocket to maximize its effective surface area for more thrust. Other innovations include new locking strap buckles and no-slip material for better traction out of the water.

### TECHNICAL FEATURES

- Made using the exclusive 3-material injection system patented by Cressi
- Foot pocket increased by 5%
- Under blade foot pocket
- Very fast transmission of the applied energy
- Great structural rigidity



Wearing fins has never been easier thanks to the special elastic, even with just one hand! The Elastic Bungee Strap holds the fin firmly to the foot and no adjustment is required!



CODE	COLOR	SIZE	CASE PACK
BE091038	Yellow/Silver	XS/S	3
BE091040	Yellow/Silver	S/M	3
BE091042	Yellow/Silver	M/L	3
BE091044	Yellow/Silver	L/XL	3
BE092038	Blue/Azure	XS/S	3
BE092040	Blue/Azure	S/M	3
BE092042	Blue/Azure	M/L	3
BE092044	Blue/Azure	L/XL	3
BE095538	Black/Silver	XS/S	3
BE095540	Black/Silver	S/M	3
BE095542	Black/Silver	M/L	3
BE095544	Black/Silver	L/XL	3
BE096438	White/Pink	XS/S	3
BE096440	White/Pink	S/M	3





OPTIONAL ACCESSORIES

CODE	PRODUCT	SIZE	CASE PACK
BZ150004	EBS FIN STRAP for ARA/FROG/PRO LIGHT/THOR - SHORT FIT	Short Fit (XS/S - S/M)	20
BZ150005	EBS FIN STRAP for ARA/FROG/PRO LIGHT/THOR - REGULAR FIT	Regular Fit (S/M - M/L)	20
BZ150006	EBS FIN STRAP for ARA/FROG/PRO LIGHT/THOR - EXTENDED FIT	Extended Fit (M/L - L/XL)	20

SIZE CONVERSION CHART				
FIN SIZE	EU FOOT SIZE	UK FOOT SIZE	US MEN FOOT SIZE	US WOMEN FOOT SIZE
X/S	35/38	2/4	3/5	4/6
S/M	38/41	4/7	5/8	6/9
M/L	41/44	7/10	8.5/11	9.5/12
L/XL	44/45	10/13	11/13	12/14

PRODUCT DIMENSION CHART			
A	B	C	D
587 mm 23 in	201 mm 8 in	325 mm 12.7 in	95 mm 3.7 in
621 mm 24.5 in	215 mm 8.4 in	346 mm 13.6 in	100 mm 3.9 in
665 mm 26 in	228 mm 8.9 in	368 mm 14.4 in	108 mm 4.2 in
698 mm 27.5 in	240 mm 9.4 in	390 mm 15.3 in	114 mm 4.5 in

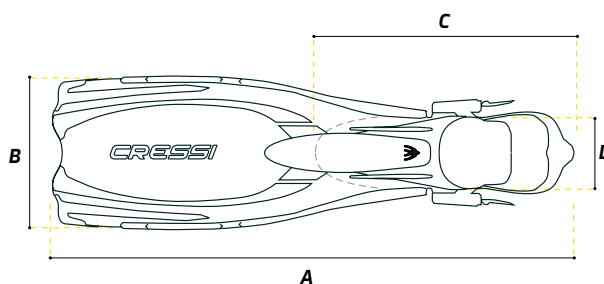

⚠️ FINN COULD COME LABELED WITH EU AND UK SIZES ONLY  
 CRESSI'S SIZE CHART TO BE USED AS A REFERENCE ONLY  
 USA REV. 06/2023



TO MAXIMIZE PERFORMANCE AND COMFORT, WEAR FINN WITH:

BARE FOOT	NEOPRENE SOCKS	NEOPRENE BOOTS 3 mm - 5 mm / 1 mm - 1.5 mm	HARD SOLE BOOTS 3 mm - 5 mm / 1 mm - 1.5 mm
-----------	----------------	---	--

# FROG PLUS



BLUE/SILVER WHITE/BLACK



BLACK/YELLOW BLACK/PINK



BLACK/SILVER

## TECHNICAL FEATURES

- Double density technology
- Superior performance

- Possibility of assembly with elastic bungee system (2)

- Compatible with: 



The Frog Plus features many of the great characteristics of a traditional paddle fin while introducing a revolutionary new blade material that is both extremely durable and nearly indestructible. The Frog Plus utilizes Cressi's patented three material injection molding process. The three materials consist of a nice comfortable rubber on the foot pocket that extends up the side rails of the blade. The second material is the revolutionary new dual density techno polymer which forms the blade, and in conjunction with the third silicone-based material, creates a channeling effect. The channeling effect is the characteristic of the fin that enables a high level of energy to be transferred in both up and down strokes of the kick pattern. The Frog Plus also incorporates Cressi's patented positioning of the foot pocket below the blade. This design increases the working surface area of the blade by 20%. The combination of the channeling effect and the foot pocket mounted beneath the blade creates a very powerful and efficient fin with minimal leg strain. Because of these characteristics, the Frog Plus fin is an ideal choice for the entry-level to advanced diver.



CODE	COLOR	SIZE	CASE PACK
BF202038	Blue/Silver	XS/S	3
BF202040	Blue/Silver	S/M	3
BF202042	Blue/Silver	M/L	3
BF202044	Blue/Silver	L/XL	3
BF203038	White/Black	XS/S	3
BF203040	White/Black	S/M	3
BF203042	White/Black	M/L	3
BF203044	White/Black	L/XL	3
BF205138	Black/Yellow	XS/S	3
BF205140	Black/Yellow	S/M	3
BF205142	Black/Yellow	M/L	3
BF205144	Black/Yellow	L/XL	3
BF205438	Black/Pink	XS/S	3
BF205440	Black/Pink	S/M	3
BF205538	Black/Silver	XS/S	3
BF205540	Black/Silver	S/M	3
BF205542	Black/Silver	M/L	3
BF205544	Black/Silver	L/XL	3







OPTIONAL ACCESSORIES

CODE	PRODUCT	STYLE
BZ170002	FIN STRAP FOR SCUBA FINS	Frog - Frog Plus - Master Frog - Pro Light - Reaction - Rondine
BZ170016	BUCKLES FOR FROG PLUS/REACTION	Rondine - Reaction - Frog Plus

SPARE PARTS

CODE	PRODUCT	SIZE	CASE PACK
BZ150004	EBS FIN STRAP for ARA/FROG/PRO LIGHT/THOR - SHORT FIT	Short Fit (XS/S - S/M)	20
BZ150005	EBS FIN STRAP for ARA/FROG/PRO LIGHT/THOR - REGULAR FIT	Regular Fit (S/M - M/L)	20
BZ150006	EBS FIN STRAP for ARA/FROG/PRO LIGHT/THOR - EXTENDED FIT	Extended Fit (M/L - L/XL)	20

SIZE CONVERSION CHART				
FIN SIZE	EU FOOT SIZE	UK FOOT SIZE	US MEN FOOT SIZE	US WOMEN FOOT SIZE
XS/S	35 / 38	2 / 5	3 / 6	4 / 7
S/M	39 / 42	5 / 7	6 / 8	7 / 9
M/L	41 / 44	8 / 10	9 / 11	10 / 12
L/XL	44 / 47	10 / 12	11 / 13	12 / 14

PRODUCT DIMENSION CHART						
A	B	C	D	FIN HEIGHT FIT	SINGLE FIN WEIGHT	
569 mm 22.5 in	198 mm 7.8 in	315 mm 12.5 in	93 mm 3.7 in	83 mm 3.3 in	675 g 24.0 oz	
606 mm 23.8 in	209 mm 8.2 in	333 mm 13.1 in	99 mm 3.9 in	88 mm 3.5 in	750 g 26.5 oz	
649 mm 25.5 in	223 mm 8.8 in	355 mm 14 in	104 mm 4.1 in	92 mm 3.6 in	900 g 32.0 oz	
683 mm 26.8 in	236 mm 9.3 in	376 mm 14.8 in	112 mm 4.4 in	94 mm 3.7 in	1025 g 36.0 oz	

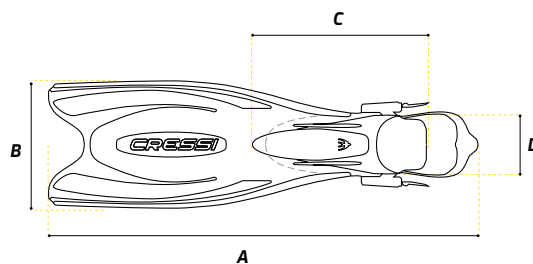

⚠️ FINS COULD COME LABELED WITH EU AND UK SIZES ONLY  
CRESSI'S SIZE CHART TO BE USED AS A REFERENCE ONLY  
USA REV. 06/2023

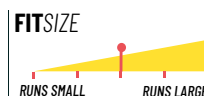

TO MAXIMIZE PERFORMANCE AND COMFORT, WEAR FINS WITH:

<input type="checkbox"/>	<input type="checkbox"/>	<input checked="" type="checkbox"/>	<input checked="" type="checkbox"/>
BARE FOOT	NEOPRENE SOCKS	NEOPRENE BOOTS 3 Sizes - 3, 200 - 7, 100	HARD SOLE BOOTS 3 Sizes - 3, 200 - 7, 100



# FROG

A CLASSIC IN THE CRESSI RANGE



A classic in the Cressi range, this has been on the market for many years and has a huge number of appreciators in every corner of the planet. The fin is made with a skillful combination of a strong copolymer and a soft elastomer, the latter used for the foot pocket, for the side stringers, and for some inserts. The blade originates from the upper part of the foot pocket, with a 20% increase in useful surface area compared to a traditional fin of the same length. The foot pocket is computer designed and offers great comfort; it guarantees excellent transmission of the leg-fin thrust. The Frog is heavier than the more recently designed equivalent Cressi models. It is this feature that makes it agreeable to whoever uses very thick suits or watertight suits. Anyone who works underwater will appreciate this fin a great deal because it is strong and comfortable, very popular also in diving schools and excellent for rental.



CODE	COLOR	SIZE	CASE PACK
BF195038	Black	XS/S	3
BF195040	Black	S/M	3
BF195042	Black	M/L	3
BF195044	Black	L/XL	3

## TECHNICAL FEATURES

- Double density technology
- Superior performance

- Possibility of assembly with elastic bungee system (2)

- Compatible with: 





Photo by: voyagesofagape

OPTIONAL ACCESSORIES

CODE	PRODUCT	STYLE
BZ170002	FIN STRAP FOR SCUBA FINS	Frog - Frog Plus - Master Frog - Pro Light - Reaction - Rondine
BZ170016	BUCKLES FOR FROG PLUS/REACTION	Rondine - Reaction - Frog Plus

SPARE PARTS

CODE	PRODUCT	SIZE	CASE PACK
BZ150004	EBS FIN STRAP for ARA/FROG/PRO LIGHT/THOR - SHORT FIT	Short Fit (XS/S - S/M)	20
BZ150005	EBS FIN STRAP for ARA/FROG/PRO LIGHT/THOR - REGULAR FIT	Regular Fit (S/M - M/L)	20
BZ150006	EBS FIN STRAP for ARA/FROG/PRO LIGHT/THOR - EXTENDED FIT	Extended Fit (M/L - L/XL)	20

SIZE CONVERSION CHART				
FIN SIZE	EU FOOT SIZE	UK FOOT SIZE	US MEN FOOT SIZE	US WOMEN FOOT SIZE
XS/S	35 / 38	2 / 5	3 / 6	4 / 7
S/M	38 / 41	5 / 7	6 / 8	7 / 9
M/L	41 / 44	8 / 10	9 / 11	10 / 12
L/XL	44 / 47	10 / 12	11 / 13	12 / 14

PRODUCT DIMENSION CHART				
A	B	C	D	FIN HEIGHT FIT
607 mm 23.8 in	201 mm 7.9 in	358 mm 14 in	90 mm 3.5 in	71 mm 2.7 in
628 mm 24.7 in	208 mm 8.1 in	365 mm 14.3 in	93 mm 3.6 in	71 mm 2.8 in
647 mm 25.4 in	214 mm 8.4 in	373 mm 14.6 in	97 mm 3.8 in	74 mm 2.9 in
671 mm 26.4 in	219 mm 8.6 in	380 mm 14.9 in	100 mm 3.9 in	76 mm 3 in

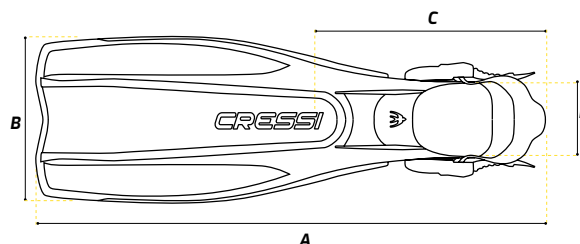

⚠️ FINS COULD COME LABELED WITH EU AND UK SIZES ONLY  
 CRESSI'S SIZE CHART TO BE USED AS A REFERENCE ONLY  
 USA REV. 06/2023

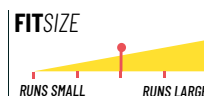

TO MAXIMIZE PERFORMANCE AND COMFORT, WEAR FINS WITH:

<input type="checkbox"/>	<input type="checkbox"/>	<input checked="" type="checkbox"/>	<input checked="" type="checkbox"/>
BARE FOOT	NEOPRENE SOCKS	NEOPRENE BOOTS 3 sizes - 3 sizes - 1 size	HARD SOLE BOOTS 3 sizes - 3 sizes - 1 size





# PRO LIGHT

## OPEN-HEEL FIN



### TECHNICAL FEATURES

- Dual material blade uses strong polypropylene and soft elastomer
- Full-length side rails help direct water flow for improved thrust
- Elastomer foot pocket improves comfort
- Blade extends from the top of the foot for increased surface area
- Quick-release strap buckles

- Possibility of assembly with elastic bungee system (2)

- Compatible with: 



YELLOW



BLUE



BLACK

These highly responsive blades are also very lightweight, and a great choice for traveling divers who want an open-heel fin. The dual-material blade balances power with kicking comfort, and full-length side rails help it track naturally through the water using a standard scissor kick. The soft elastomer foot pocket is shaped for an ergonomic and comfortable fit.



CODE	COLOR	SIZE	CASE PACK
BG171038	Yellow	XS	3
BG171040	Yellow	S/M	3
BG171042	Yellow	M/L	3
BG171044	Yellow	XL	3
BG172038	Blue	XS	3
BG172040	Blue	S/M	3
BG172042	Blue	M/L	3
BG172044	Blue	XL	3
BG175038	Black	XS	3
BG175040	Black	S/M	3
BG175042	Black	M/L	3
BG175044	Black	XL	3
BG175046	Black	2XL	3





OPTIONAL ACCESSORIES

CODE	PRODUCT	STYLE
BZ170002	FIN STRAP FOR SCUBA FINS	Frog - Frog Plus - Master Frog - Pro Light - Reaction - Rondine
BZ170016	BUCKLES FOR FROG PLUS/REACTION	Rondine - Reaction - Frog Plus

SPARE PARTS

CODE	PRODUCT	SIZE	CASE PACK
BZ150004	EBS FIN STRAP for ARA/FROG/PRO LIGHT/THOR - SHORT FIT	Short Fit (XS/S - S/M)	20
BZ150005	EBS FIN STRAP for ARA/FROG/PRO LIGHT/THOR - REGULAR FIT	Regular Fit (S/M - M/L)	20
BZ150006	EBS FIN STRAP for ARA/FROG/PRO LIGHT/THOR - EXTENDED FIT	Extended Fit (M/L - L/XL)	20

SIZE CONVERSION CHART				
FIN SIZE	EU FOOT SIZE	UK FOOT SIZE	US MEN FOOT SIZE	US WOMEN FOOT SIZE
XS	37 / 39	4 / 6	5 / 7	6 / 7
S/M	38 / 41	5 / 7	6.5 / 8	7.5 / 9
M/L	41 / 44	7 / 10	8.5 / 11	9.5 / 12
XL	44 / 45	10 / 11	11 / 12	12 / 13
XXL	46 / 47	11 / 12	12 / 13	13 / 14

PRODUCT DIMENSION CHART					
A	B	C	D	FIN HEIGHT FIT	SINGLE FIN WEIGHT
575 mm 22.6 in	198 mm 7.8 in	312 mm 12.3 in	97 mm 3.9 in	83 mm 3.3 in	675 g 24.0 oz
608 mm 23.9 in	211 mm 8.3 in	332 mm 13.1 in	107 mm 4.2 in	88 mm 3.5 in	750 g 26.5 oz
648 mm 25.5 in	223 mm 8.8 in	354 mm 14 in	112 mm 4.4 in	92 mm 3.6 in	900 g 32.0 oz
679 mm 26.7 in	233 mm 9.2 in	372 mm 14.7 in	117 mm 4.6 in	94 mm 3.7 in	1025 g 36.0 oz
688 mm 27 in	242 mm 9.6 in	374 mm 14.8 in	124 mm 4.9 in	94 mm 3.7 in	1025 g 36.0 oz

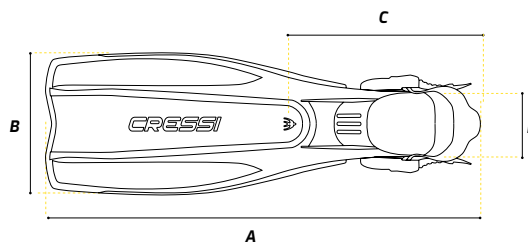

⚠️ FINS COULD COME LABELED WITH EU AND UK SIZES ONLY  
 CRESSI'S SIZE CHART TO BE USED AS A REFERENCE ONLY  
 USA REV. 06/2023



TO MAXIMIZE PERFORMANCE AND COMFORT, WEAR FINN WITH:

BARE FOOT	NEOPRENE SOCKS	NEOPRENE BOOTS 3 mm - 5 mm - 7 mm	HARD SOLE BOOTS 3 mm - 5 mm - 7 mm



IDEAL FOR  
TRAVEL



ALSO FOR  
RENTAL

# MAUI

## OPEN HEEL SNORKELING FINS



### TECHNICAL FEATURES

- Short blade adjustable open heel fins.
- Elastic Bungee Strap (EBS) system patented by Cressi.
- Colored strap by size for dive centers.

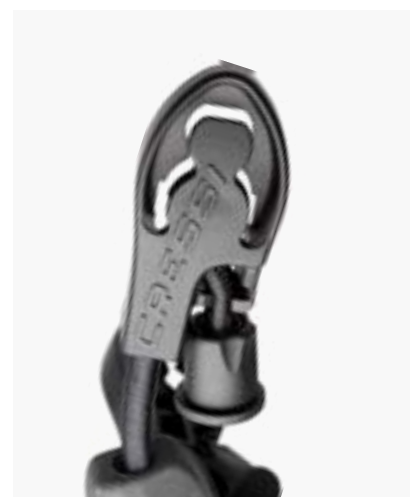

BLUE

BLACK / RED

The Maui fin is all about lightweight, user-friendliness, and adaptable performance. Designed with advanced finite elements technology, it combines rigid lateral wings with a flexible central section, creating a "spoon effect" for powerful propulsion. You can use it with bare feet or light socks. The EBS strap's fabric covering ensures durability, while the soft anatomical rubber heel piece enhances comfort. An ankle wrap grab handle minimizes protrusion and chafing. The elastic strap features a cleat for easy adjustments, ensuring a secure yet comfortable fit, whether you're wearing socks or not. Dive Centers offer color-coded heel pieces for size identification, making it a great choice for divers of all levels.



CODE	COLOR	SIZE	CASE PACK
CA155238	Black/Blue	S/M	3
CA155241	Black/Blue	M/L	3
CA155244	Black/Blue	L/XL	3
CA155838	Black/Red	S/M	3
CA155841	Black/Red	M/L	3
CA155844	Black/Red	L/XL	3





EBS STRAPS



EBS STRAPS FOR DIVE CENTERS

Dive Centers fins will have heel pieces colour-coded according to sizes to facilitate identification. Only on black/red version.

SPARE PARTS

CODE	PRODUCT
CZ145200	EBS STRAPS MAUI - BLUE (2pcs)
CZ145500	EBS STRAPS MAUI - BLACK (pair)
CZ145550	EBS STRAPS MAUI - GREY (pair)
CZ145800	EBS STRAPS MAUI - RED (pair)

SIZE CONVERSION CHART				
FIN SIZE	EU FOOT SIZE	UK FOOT SIZE	US MEN FOOT SIZE	US WOMEN FOOT SIZE
S/M	38 / 41	4 / 7	6.5 / 8	7.5 / 9
M/L	41 / 44	7 / 10	8.5 / 11	9.5 / 12
L/XL	44 / 47	10 / 12	11 / 13	12 / 14

PRODUCT DIMENSION CHART			
A	B	C	D
54,5 cm 21 1/2 in	20,5 cm 8 1/8 in	25,0 cm 9 7/8 in	7,5 cm 3 in
57,0 cm 22 1/2 in	21 cm 8 1/4 in	26 cm 10 1/4 in	7,7 cm 3 in
59,5 cm 23 3/8 in	21,5 cm 8 1/2 in	27,0 cm 10 5/8 in	8,0 cm 3 1/8 in

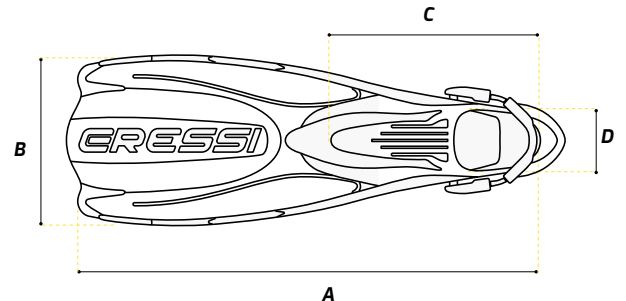

⚠️ FINS COULD COME LABELED WITH EU AND UK SIZES ONLY  
CRESSI'S SIZE CHART TO BE USED AS A REFERENCE ONLY  
USA REV. 06/2023

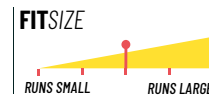

TO MAXIMIZE PERFORMANCE AND COMFORT, WEAR FIN WITH:

<input checked="" type="checkbox"/>	<input checked="" type="checkbox"/>	<input type="checkbox"/>	<input type="checkbox"/>
BARE FOOT	NEOPRENE SOCKS	NEOPRENE BOOTS 3 mm - 5 mm - 7 mm	HARD SOLE BOOTS 3 mm - 5 mm - 7 mm

# MAUI SHORT

OPEN HEEL SNORKELING FINS



MAUI EBS STRAP

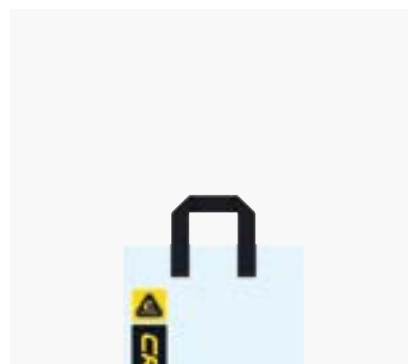

The Maui Short fin is perfect for open water, confined spaces, and snorkeling. Its robust design makes it an excellent choice for beach safety and rescue teams. Developed using advanced calculation programs, it features two side rails made from different materials, ensuring a perfect balance of flexibility and performance. The EBS strap, constructed with elastic rubbers and nylon lining, offers durability and abrasion resistance. The soft rubber heel piece is anatomically shaped for comfort and can be used with or without neoprene socks. The streamlined handle is placed to avoid interfering with leg and foot movement during swimming. To fine-tune the fit and prevent accidental release, a choker has been added to the elastic bands. The Maui Short is the go-to fin for sea and pool swimming, snorkeling, and beach rescue operations.

CODE	COLOR	SIZE
CA165238	Black/Blue	S/M
CA165241	Black/Blue	M/L
CA165244	Black/Blue	L/XL





SPARE PARTS

CODE	PRODUCT
CZ145200	EBS STRAPS MAUI - BLUE (2pcs)

SIZE CONVERSION CHART				
FIN SIZE	EU FOOT SIZE	UK FOOT SIZE	US MEN FOOT SIZE	US WOMEN FOOT SIZE
S/M	38 / 41	4 / 7	6.5 / 8	7.5 / 9
M/L	41 / 44	7 / 10	8.5 / 11	9.5 / 12
L/XL	44 / 47	10 / 12	11 / 13	12 / 14

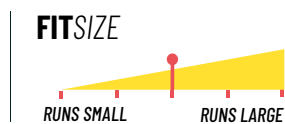

TO MAXIMIZE PERFORMANCE AND COMFORT, WEAR FINN WITH:

<input checked="" type="checkbox"/>	<input checked="" type="checkbox"/>	<input type="checkbox"/>	<input type="checkbox"/>
BARE FOOT	NEOPRENE SOCKS	NEOPRENE BOOTS 3 mm + 5 mm + 7 mm	HARD SOLE BOOTS 3 mm + 5 mm + 7 mm



# GARA MODULAR SPRINT TURBO

## 29° DEGREE ANGLED INTERCHANGEABLE BLADE



### TECHNICAL FEATURES

- Thermoplastic self-adjustable rubber foot pocket
- Foot pocket with shorter side rails, to increase performance
- Exchangeable Gara blade system
- Extremely thin and light blade in compound made of elastomeric technopolymers developed by Cressi with different thicknesses
- Foot pocket/blade angle of 29 degrees



GARA TURBO  
FOOT POCKET

### INCLUDED GARA MODULAR INSOLE

The insole for Gara Modular fins is recommended for use with thin boots in temperate waters, because it improves the kick performance. The semi-rigid material of the insole is completely recycled. The insoles are supplied as a pair (right and left foot) and can be cut into their shape in three different sizes, according to pre-printed guidelines.

- Down-size Gara Fins foot pocket preformed sole
- Easily adjust size
- Non-corrosive plastic construction



The Gara Modular Sprint Turbo is the 2022 update to the popular Sprint model in the Gara Modular line. It's a shorter version of the Impulse fin, designed for freedivers and spearfishers during the winter months or when a longer fin isn't necessary. Both fins are meticulously designed using advanced finite element software for complex and high-performance sections. The Sprint's blade is made of thermoplastic elastomer, with an angled sublayer and overlay. The sublayer covers most of the fin, offering uniform thickness and a flexible longitudinal propulsion wing. The overlay selectively covers the propulsion wing, with thickness tapering towards the blade tip. This unique design stores and releases elastic potential energy, improving propulsion. When disassembled, it's as compact as a regular snorkeling fin. This version features the Modular Turbo Foot Pocket with shorter side rails for enhanced performance.

### WATER RAILS SYSTEM

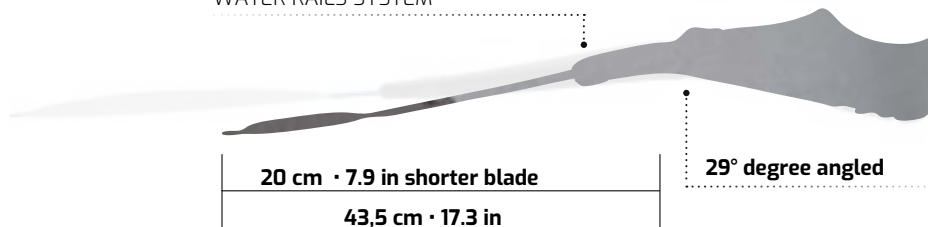

CODE	COLOR	SIZE	CASE PACK
BH175036	Black	36/37	3
BH175038	Black	38/39	3
BH175040	Black	40/41	3
BH175042	Black	42/43	3
BH175044	Black	44/45	3
BH175046	Black	46/47	3



OPTIONAL ACCESSORIES

CODE	PRODUCT
BZ175032	RUBBER FIN KEEPER (PAIR) - BLACK (S)
BZ175033	RUBBER FIN KEEPER (PAIR) - BLACK (M)
BZ175034	RUBBER FIN KEEPER (PAIR) - BLACK (L)
BZ180022	INSOLE FOR GARA FINS

SPARE PARTS

CODE	PRODUCT
BZ180020	GARA MODULAR ASSEMBLY KIT
BH015036	GARA MODULAR TURBO FOOT POCKET [36/37]
BH015038	GARA MODULAR TURBO FOOT POCKET [38/39]
BH015040	GARA MODULAR TURBO FOOT POCKET [40/41]
BH015042	GARA MODULAR TURBO FOOT POCKET [42/43]
BH015044	GARA MODULAR TURBO FOOT POCKET [44/45]
BH015046	GARA MODULAR TURBO FOOT POCKET [46/47]

SIZE CONVERSION CHART				
FIN SIZE	EU FOOT SIZE	UK FOOT SIZE	US MEN FOOT SIZE	US WOMEN FOOT SIZE
36 / 37	36 / 37	3 / 4	4 / 5	5 / 6
37 / 38	37 / 38	5 / 6	6 / 7	7 / 8
39 / 40	39 / 40	6.5 / 7	7.5 / 8	8.5 / 9
41 / 42	41 / 42	8 / 9	9 / 10	10 / 11
43 / 44	43 / 44	10 / 10.5	11 / 11.5	12 / 12.5
45 / 46	45 / 46	11 / 12	12 / 13	13 / 14

PRODUCT DIMENSION CHART				
A	B	C	FIN HEIGHT FIT	SINGLE FIN WEIGHT
671 mm 26.4 in	215 mm 8.5 in	430 mm 16.9 in	83 mm 3.3 in	678 g 23.9 oz
683 mm 26.9 in	215 mm 8.5 in	430 mm 16.9 in	84 mm 3.3 in	712 g 25.1 oz
700 mm 27.6 in	215 mm 8.5 in	430 mm 16.9 in	87 mm 3.4 in	738 g 26.0 oz
712 mm 28.0 in	215 mm 8.5 in	430 mm 16.9 in	92 mm 3.6 in	783 g 27.6 oz
725 mm 28.5 in	215 mm 8.5 in	430 mm 16.9 in	97 mm 3.8 in	848 g 29.9 oz
734 mm 28.9 in	215 mm 8.5 in	430 mm 16.9 in	103 mm 4.1 in	916 g 32.3 oz

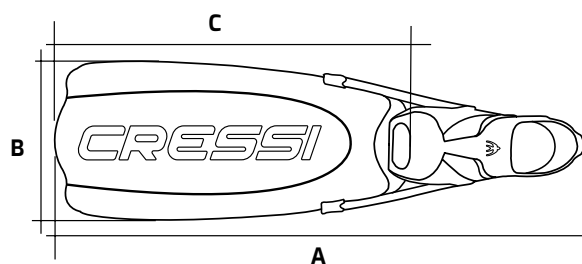

⚠️ FIN S COULD COME LABELED WITH EU AND UK SIZES ONLY  
CRESSI'S SIZE CHART TO BE USED AS A REFERENCE ONLY

FITSIZE



TO MAXIMIZE PERFORMANCE AND COMFORT, WEAR FIN S WITH:

<input checked="" type="checkbox"/>	<input checked="" type="checkbox"/>	<input checked="" type="checkbox"/>	<input checked="" type="checkbox"/>
BARE FOOT	NEOPRENE SOCKS	NEOPRENE BOOTS 3 mm - 5 mm - 7 mm	HARD SOLE BOOTS 6 mm - 8 mm - 7 mm

# GARA MODULAR SPRINT

29° DEGREE ANGLED INTERCHANGEABLE BLADE



## TECHNICAL FEATURES

- Thermoplastic self-adjustable rubber foot pocket
- Exchangeable Gara blade system
- Extremely thin and light blade in compound made of elastomeric technopolymers developed by Cressi with different thicknesses
- Foot pocket/blade angle of 29 degrees

29° DEGREE ANGLED NEW SEMI-LONG BLADE

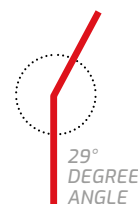

GARA MODULAR SPRINT

20 cm - 7.9 in



29° DEGREE ANGLE

GARA MODULAR IMPULSE



BLUE METAL



BLACK

The Gara Modular Sprint fin, part of the Cressi Gara line, is a 2020 model. It's a shorter alternative to the popular Impulse fin, favored by freedivers worldwide, including professionals and amateurs. Sprint is tailored for winter freediving and situations where the longer Impulse isn't needed.

Both fins are meticulously designed using advanced finite element software, allowing for highly complex and high-performance sections. The Sprint's blade is crafted from a single thermoplastic elastomer, featuring an angled sublayer and an overlay. The sublayer covers most of the fin, providing uniform thickness and a flexible, longitudinally variable propulsion wing.

In contrast, the overlay selectively covers the propulsion wing, with thickness tapering towards the blade tip. This innovative design stores and releases elastic potential energy, greatly aiding the freediver's leg movement, resulting in improved propulsion. When disassembled, the fin's blade and foot pocket occupy the space of a standard snorkeling fin.

FOOT POCKET



CODE	COLOR	SIZE	CASE PACK
BH082036	Blue	36/37	3
BH082038	Blue	38/39	3
BH082040	Blue	40/41	3
BH082042	Blue	42/43	3
BH082044	Blue	44/45	3
BH082046	Blue	46/47	3
BH085036	Black	36/37	3
BH085038	Black	38/39	3
BH085040	Black	40/41	3
BH085042	Black	42/43	3
BH085044	Black	44/45	3
BH085046	Black	46/47	3





ACCESSORIES

CODE	PRODUCT
BZ175032	RUBBER FIN KEEPER (PAIR) - BLACK (S)
BZ175033	RUBBER FIN KEEPER (PAIR) - BLACK (M)
BZ175034	RUBBER FIN KEEPER (PAIR) - BLACK (L)
BZ180022	INSOLE FOR GARA FINS

SPARE PARTS

CODE	PRODUCT
BZ180020	GARA MODULAR ASSEMBLY KIT
BH005036	GARA MODULAR FOOT POCKET (PAIR) [36/37]
BH005038	GARA MODULAR FOOT POCKET (PAIR) [38/39]
BH005040	GARA MODULAR FOOT POCKET (PAIR) [40/41]
BH005042	GARA MODULAR FOOT POCKET (PAIR) [42/43]
BH005044	GARA MODULAR FOOT POCKET (PAIR) [44/45]
BH005046	GARA MODULAR FOOT POCKET (PAIR) [46/47]

INCLUDED GARA MODULAR INSOLE

The insole for Gara Modular fins is recommended for use with thin boots in temperate waters, because it improves the kick performance. The semi-rigid material of the insole is completely recycled. The insoles are supplied as a pair (right and left foot) and can be cut into their shape in three different sizes, according to pre-printed guidelines.

- Down-size Gara Fins foot pocket preformed sole
- Easily adjust size
- Non- corrosive plastic construction



SIZE CONVERSION CHART				
FIN SIZE	EU FOOT SIZE	UK FOOT SIZE	US MEN FOOT SIZE	US WOMEN FOOT SIZE
36 / 37	36 / 37	3 / 4	4 / 5	5 / 6
37 / 38	37 / 38	5 / 6	6 / 7	7 / 8
39 / 40	39 / 40	6.5 / 7	7.5 / 8	8.5 / 9
41 / 42	41 / 42	8 / 9	9 / 10	10 / 11
43 / 44	43 / 44	10 / 10.5	11 / 11.5	12 / 12.5
45 / 46	45 / 46	11 / 12	12 / 13	13 / 14

PRODUCT DIMENSION CHART				
A	B	C	FIN HEIGHT FIT	SINGLE FIN WEIGHT
671 mm 26.4 in	215 mm 8.5 in	430 mm 16.9 in	83 mm 3.3 in	678 g 23.9 oz
683 mm 26.9 in	215 mm 8.5 in	430 mm 16.9 in	84 mm 3.3 in	712 g 25.1 oz
700 mm 27.6 in	215 mm 8.5 in	430 mm 16.9 in	87 mm 3.4 in	738 g 26.0 oz
712 mm 28.0 in	215 mm 8.5 in	430 mm 16.9 in	92 mm 3.6 in	783 g 27.6 oz
725 mm 28.5 in	215 mm 8.5 in	430 mm 16.9 in	97 mm 3.8 in	848 g 29.9 oz
734 mm 28.9 in	215 mm 8.5 in	430 mm 16.9 in	103 mm 4.1 in	916 g 32.3 oz

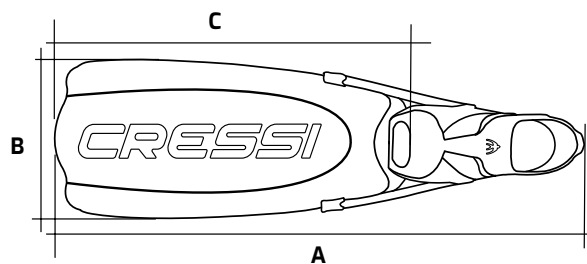

⚠️ FINS COULD COME LABELED WITH EU AND UK SIZES ONLY  
CRESSI'S SIZE CHART TO BE USED AS A REFERENCE ONLY

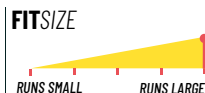

TO MAXIMIZE PERFORMANCE AND COMFORT, WEAR FINS WITH:

<input checked="" type="checkbox"/>	<input checked="" type="checkbox"/>	<input type="checkbox"/>	<input type="checkbox"/>
BARE FOOT	NEOPRENE SOCKS	NEOPRENE BOOTS 3 mm - 5 mm - 7 mm	HARD SOLE BOOTS 8 mm - 9 mm - 12 mm

# REACTION PRO

## FOOT POCKET FIN



### TECHNICAL FEATURES

- Excellent propulsive performance
- full foot pocket for comfort
- Long blade for efficiency
- Thermo-rubber soles for extra grip on wet surfaces

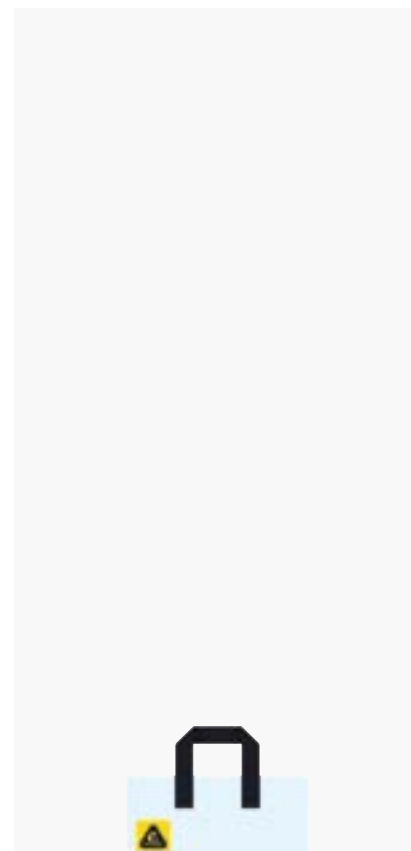

BLUE/AZURE

BLACK/SILVER

It is a great all-around fin for scuba, snorkeling, and freediving. The Reaction Pro is a full foot pocket style fin, with a long blade and built-in runners to effectively direct water flow down the blade. The Reaction Pro is constructed using multiple materials, bonded together with our patented three-material molding process. This provides comfort and suppleness in the foot area as well as strength and rigidity in the heel and blade for added power and efficiency. The soles are completely covered in thermo-rubber to give them exceptional grip on boat decks. Can comfortably be worn with or without dive socks.

CODE	COLOR	SIZE	CASE PACK
BG192036	Blue	36/37	3
BG192038	Blue	38/39	3
BG192040	Blue	40/41	3
BG192042	Blue	42/43	3
BG192044	Blue	44/45	3
BG192046	Blue	46/47	3
BG195036	Black	36/37	3
BG195038	Black	38/39	3
BG195040	Black	40/41	3
BG195042	Black	42/43	3
BG195044	Black	44/45	3
BG195046	Black	46/47	3



ACCESSORIES

CODE	PRODUCT
BZ175032	RUBBER FIN KEEPER (PAIR) - BLACK (S)
BZ175033	RUBBER FIN KEEPER (PAIR) - BLACK (M)
BZ175034	RUBBER FIN KEEPER (PAIR) - BLACK (L)

SIZE CONVERSION CHART				
FIN SIZE	EU FOOT SIZE	UK FOOT SIZE	US MEN FOOT SIZE	US WOMEN FOOT SIZE
36/37	36/37	3 / 4	4 / 5	5 / 6
38/39	38/39	5 / 6	6 / 7	7 / 8
40/41	40/41	6.5 / 7	7.5 / 8	8.5 / 9
42/43	42/43	8 / 9	9 / 10	10 / 11
44/45	44/45	10 / 10.5	11 / 11.5	12 / 12.5
46/47	46/47	11 / 12	12 / 13	13 / 14

PRODUCT DIMENSION CHART				
A	B	C	SINGLE FIN WEIGHT	
600 mm 23.6 in	203 mm 8 in	475 mm 18.8 in	625 g 22.0 oz	
620 mm 24.5 in	215 mm 8.5 in	495 mm 19.5 in	710 g 25.0 oz	
640 mm 25.2 in	215 mm 8.5 in	500 mm 19.7 in	765 g 27.0 oz	
665 mm 26.2 in	215 mm 8.5 in	520 mm 20.5 in	830 g 29.2 oz	
680 mm 26.8 in	215 mm 8.5 in	545 mm 21.5 in	880 g 31.0 oz	
700 mm 27.5 in	215 mm 8.5 in	555 mm 21.9 in	935 g 33.0 oz	

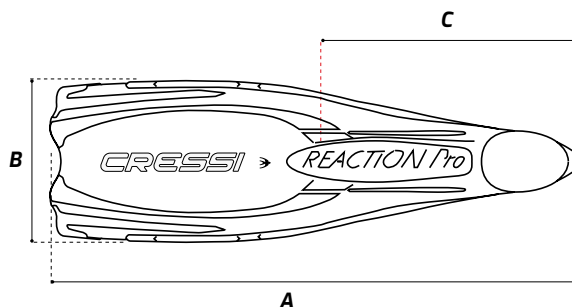

**⚠** FINS COULD COME LABELED WITH EU AND UK SIZES ONLY  
 CRESSI'S SIZE CHART TO BE USED AS A REFERENCE ONLY  
 USA REV. 06/2023

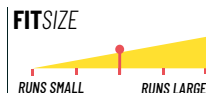

TO MAXIMIZE PERFORMANCE AND COMFORT, WEAR FINN WITH:

<input checked="" type="checkbox"/>	<input checked="" type="checkbox"/>	<input type="checkbox"/>	<input type="checkbox"/>
BARE FOOT	NEOPRENE SOCKS	NEOPRENE BOOTS 3 mm - 5 mm / 1/8" - 1/4"	HARD SOLE BOOTS 3 mm - 5 mm / 1/8" - 1/4"



# PRO STAR

## FOOT POCKET FIN



### TECHNICAL FEATURES

- Excellent propulsive performance
- full foot pocket for comfort
- Long blade for efficiency
- Thermo-rubber soles for extra grip on wet surfaces



YELLOW



BLACK

It is a truly versatile fin, an exceptional choice for scuba, snorkeling, and freediving. Inspired by the Pro Light, the Pro Star is a lightweight and comfortable foot pocket-style fin. For power transference, it incorporates the blade beneath the foot pocket and the angle of the blade provides the ultimate efficiency during the kick cycle, requiring less energy to load the blade. This fin is constructed using multiple compounds bonded together to provide comfort around the foot, yet strong enough to transfer strength where needed.

CODE	COLOR	SIZE	CASE PACK
BG181037	Yellow	37/38	4
BG181039	Yellow	39/40	4
BG181041	Yellow	41/42	4
BG181043	Yellow	43/44	4
BG181045	Yellow	45/46	4
BG185037	Black	37/38	4
BG185039	Black	39/40	4
BG185041	Black	41/42	4
BG185043	Black	43/44	4
BG185045	Black	45/46	4



Photo by: voyagesofagape

ACCESSORIES

CODE	PRODUCT
BZ175032	RUBBER FIN KEEPER (PAIR) - BLACK (S)
BZ175033	RUBBER FIN KEEPER (PAIR) - BLACK (M)
BZ175034	RUBBER FIN KEEPER (PAIR) - BLACK (L)

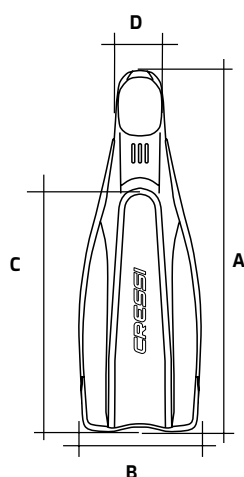

**FITSIZE**



To maximize performance and comfort, wear fins with:

<input checked="" type="checkbox"/>	<input checked="" type="checkbox"/>	<input type="checkbox"/>	<input type="checkbox"/>
<b>BARE FOOT</b>	<b>NEOPRENE SOCKS</b>	3 mm 5 mm 7 mm <b>NEOPRENE BOOTS</b>	3 mm 5 mm 7 mm <b>HARD SOLE BOOTS</b>

FIN SIZE	PRODUCT DIMENSION CHART						SIZE CONVERSION CHART			
	A LENGTH	B WIDTH	C BLADE	D WIDTH FIT	FIN HEIGHT FIT	SINGLE FIN WEIGHT	EU FOOT SIZE	UK FOOT SIZE	US MEN'S FOOT SIZE	US WOMEN'S FOOT SIZE
<b>37/38</b>	607 mm 23.9 in	201 mm 8 in	358 mm 14.1 in	90 mm 3.6 in	71 mm 2.8 in	578 g 20.4 oz	<b>37/38</b>	<b>4 / 5</b>	<b>5.5 / 6.5</b>	<b>6.5 / 7.5</b>
<b>39/40</b>	628 mm 24.8 in	208 mm 8.2 in	365 mm 14.4 in	93 mm 3.7 in	71 mm 2.8 in	623 g 22.0 oz	<b>39/40</b>	<b>5.5 / 6.5</b>	<b>7 / 8</b>	<b>8 / 9</b>
<b>41/42</b>	647 mm 25.5 in	214 mm 8.5 in	373 mm 14.7 in	97 mm 3.8 in	74 mm 2.9 in	646 g 22.8 oz	<b>41/42</b>	<b>7 / 8</b>	<b>8.5 / 9.5</b>	<b>9.5 / 10.5</b>
<b>43/44</b>	671 mm 26.4 in	219 mm 8.6 in	380 mm 15 in	100 mm 3.9 in	76 mm 3 in	725 g 25.6 oz	<b>43/44</b>	<b>8.5 / 9.5</b>	<b>10 / 11</b>	<b>11 / 12</b>
<b>45/46</b>	688 mm 27.1 in	223 mm 8.8 in	387 mm 15.3 in	102 mm 4.1 in	77 mm 3.1 in	782 g 27.6 oz	<b>45/46</b>	<b>10 / 11</b>	<b>11.5 / 12.5</b>	<b>12.5 / 13.5</b>

Cressi's Size Chart is to be used as a reference only  
Fins could come labeled with EU and UK sizes only

# FREE FROG

## FOOT POCKET FIN



BLUE

BLACK

RED



The Free Frog is back! The fin has been remade with the new molding technology. The foot pocket has been improved to fit better to most different foot shapes.

The Free Frog enjoys the exclusive characteristics of the Cressi diving fins maintaining the spirit of the legendary Frog. It features a below blade foot pocket in order to have a bigger surface that increases the kicking thrust. It is manufactured in a variant of low-modulus polypropylene that, combined with a particular structure, combines a great flexibility, softness, and resistance to a demanding use (even in rental and instructional facilities), durability and an unprecedented aesthetics in fins projected with this philosophy.

CODE	COLOR	SIZE	CASE PACK
BR152237	Blue	37/38	3
BR152239	Blue	39/40	3
BR152241	Blue	41/42	3
BR152243	Blue	43/44	3
BR152245	Blue	45/46	3
BR155037	Black	37/38	3
BR155039	Black	39/40	3
BR155041	Black	41/42	3
BR155043	Black	43/44	3
BR155045	Black	45/46	3
JBR155837	Red	37/38	3
JBR155839	Red	39/40	3
JBR155841	Red	41/42	3
JBR155843	Red	43/44	3
JBR155845	Red	45/46	3







ACCESSORIES

CODE	PRODUCT
BZ175032	RUBBER FIN KEEPER (PAIR) - BLACK (S)
BZ175033	RUBBER FIN KEEPER (PAIR) - BLACK (M)
BZ175034	RUBBER FIN KEEPER (PAIR) - BLACK (L)

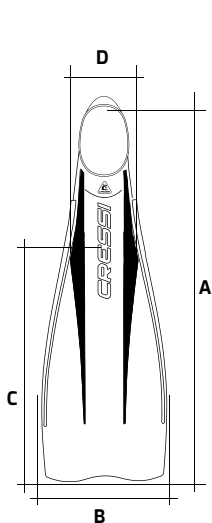

**FIT SIZE**



To maximize performance and comfort, wear fins with:

✓	✓		
BARE FOOT	NEOPRENE SOCKS	NEOPRENE BOOTS 3 mm 5 mm 7 mm	HARD SOLE BOOTS 3 mm 5 mm 7 mm

FIN SIZE	PRODUCT DIMENSION CHART						SIZE CONVERSION CHART			
	A LENGTH	B WIDTH	C BLADE	D WIDTH FIT	FIN HEIGHT FIT	SINGLE FIN WEIGHT	EU FOOT SIZE	UK FOOT SIZE	US MEN'S FOOT SIZE	US WOMEN'S FOOT SIZE
37 / 38	607 mm 23.9 in	201 mm 7.9 in	358 mm 14.1 in	90 mm 3.5 in	71 mm 2.8 in	578 g 20.4 oz	37/38	4 / 5	5 / 6	6 / 7
39 / 40	628 mm 24.7 in	208 mm 8.2 in	365 mm 14.4 in	93 mm 3.7 in	71 mm 2.8 in	623 g 22.0 oz	39/40	5.5 / 6.5	6.5 / 7.5	7.5 / 8.5
41 / 42	647 mm 25.5 in	214 mm 8.4 in	373 mm 14.7 in	97 mm 3.8 in	74 mm 2.9 in	646 g 22.8 oz	41/42	7 / 8	8 / 9	9 / 10
43 / 44	671 mm 26.4 in	219 mm 8.6 in	389 mm 15.0 in	100 mm 3.9 in	76 mm 3.0 in	725 g 23.7 oz	43/44	8.5 / 9.5	9.5 / 10.5	10.5 / 11.5
45 / 46	688 mm 27.1 in	223 mm 8.8 in	387 mm 15.2 in	102 mm 4.0 in	77 mm 3.0 in	782 g 24.3 oz	45/46	10/11	11/12	12/13

Chart measurements taken with 3mm boot with sole  
Fins could come labeled with EU and UK sizes only

Cressi's Size Chart is to be used as a reference only

# ELASTIC BUNGEE SYSTEM

Cressi has developed this special strap to meet the needs of the most demanding divers, who need a comfortable fastening for their foot that is still practical and manageable. Its amply sized slot makes it very easy to put on, even when wearing thick gloves or three-fingered gloves.

The wrapping section is highly flexible, making adjustments while underwater unnecessary. The EBS system ensures fins will stay in place against your foot despite the increase in hydrostatic pressure.



## ELASTIC BUNGEE SYSTEM (1)

DESIGNED FOR  
ARA  
FROG  
PRO LIGHT  
THOR



CODE	PRODUCT	FIN SIZE
BZ150004	EBS Fin Strap - Short Fit - Pair	XS/S - S/M
BZ150005	EBS Fin Strap - Regular Fit - Pair	S/M - M/L
BZ150006	EBS Fin Strap - Extended Fit - Pair	M/L - L/XL

## ELASTIC BUNGEE SYSTEM (2)

DESIGNED FOR  
FROG PLUS  
REACTION

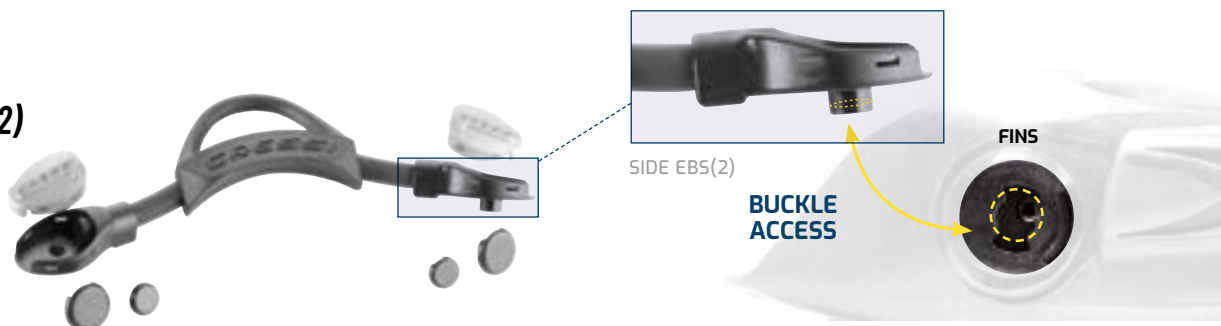

CODE	PRODUCT	FIN SIZE
BZ150001	EBS Fin Strap - Short Fit - Pair	XS/S - S/M
BZ150002	EBS Fin Strap - Regular Fit - Pair	S/M - M/L
BZ150003	EBS Fin Strap - Extended Fit - Pair	M/L - L/XL

# STANDARD FIN STRAP

Straps for open heel fins are made with long lasting rubber. The strap is padded in the area which is in contact with the back of the heel, to ensure better comfort. Each strap is designed with ridges to adjust the length by use of the buckles.

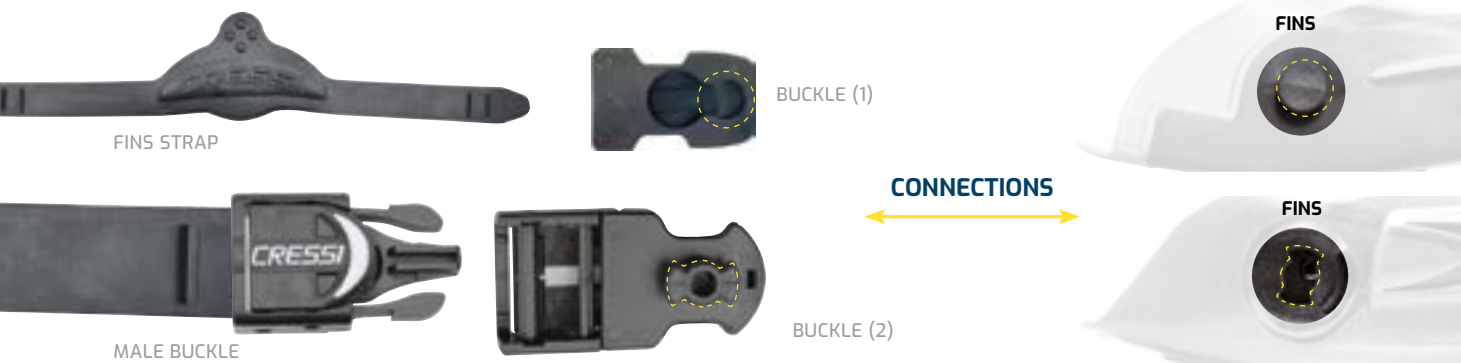

CODE	PRODUCT
BZ170002	FIN STRAP (COMPATIBILITY ALL SCUBA FINS) - 1 UNIT
BZ170015	BUCKLES (1) (FROG   PRO LIGHT   THOR) - 2 UNITS
BZ170016	BUCKLES (2) (FROG PLUS   REACTION) - 2 UNITS



# MASKS

SCUBA





# QUANTUM

NEW REVOLUTIONARY ANTI-FOG SYSTEM



## TECHNICAL FEATURES

- Cressi's patent revolutionary Fog-Stop system
- Heat exchanger
- U.S. PAT 6272693 B1 - Integrated dual frame technology
- Inclined lenses and slender structure optimize visibility
- Inverted teardrop lens shape to increase downward visibility
- Swivel buckles with micrometric adjustment
- Lenses in tempered glass
- Anatomical strap
- Strap created by double injection molding technology
- Can mount corrective optical lenses



DOUBLE INJECTION SILICONE STRAP

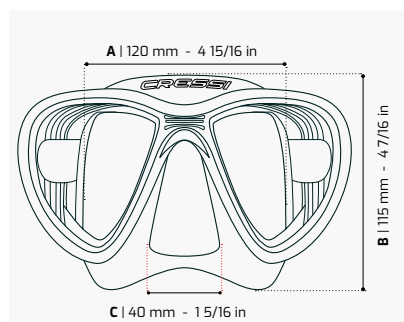

### SKIRT SIZE



### NOSE SIZE



CRESSI'S SIZE CHART TO BE USED AS A REFERENCE ONLY

The Quantum mask introduces a groundbreaking innovation. It enhances downward vision while effectively preventing fogging by internally regulating warm, damp air exiting the nose. This air is channeled by a system of membranes set in the molding around the eyes and nose and deviating the flow towards the rubber skirt rather than the lenses. The external part of the skirt features a cooling system composed of two small heat exchangers that act as radiators. The effect is that the temperature inside the mask drops, coming closer to the external temperature and the droplets of humidity are trapped before

the air reaches the lenses, preventing them from fogging up. Despite the presence of the small internal membranes deviating from the airflow and the external heat exchangers, the body of the Quantum mask is nonetheless compact and it represents the most advanced design offered on the underwater vision market. The lenses are not treated chemically and it should be remembered that when the mask is new, as is the case with all masks, we advise cleaning the lenses carefully with water and proper detergent for dive mask lenses.



CLEAR/BLACK

CLEAR/BLUE

CLEAR/PINK

BLACK/BLACK

BLACK/RED

BLACK/BLUE

BLACK/YELLOW

BLUE METAL

BLACK  
420 UV BLUE/RED LENSES  
HIGH ENERGY VISIBLE LIGHT PROTECTION

BLACK  
SPECTRA MIRRORED LENSES  
60% UV SEMI-REFLECTIVE



## COATED LENSES

FEATURES DETAILS  
Pag 141



PACKAGING

# INNER MEMBRANES + HEAT EXCHANGER

## INNER MEMBRANES

A patented membrane surrounding the inner nose pocket (1) and both the inner eye pockets (2) which acts as a barrier and traps any moisture escaping from the diver's nose involuntarily when breathing through the mouth. The result is that not only is the moisture channeled away from the lenses, thus avoiding the fogging up of them, but it also reduces the need to compensate for pressure. To further improve the anti-fog effect, Cressi suggests, the first times that the dive mask is used, to spray some anti-fog solution or to apply some saliva on the inside of the lenses and then to rinse them with water.

## HEAT EXCHANGER

The external part of the skirt features a cooling system composed of two small heat exchangers that act as radiators (3). Thanks to this system, the temperature inside mask drops, coming closer to the external temperature and the droplets of humidity are trapped before the air reaches the lenses, preventing them from fogging up.



CODE	COLOR	CASE PACK
D5510020	Clear/Blue	6
D5510040	Clear/Pink	6
D5510050	Clear/Black	6
D5512020	Blue /Metal	6
D551 5010	Black/Yellow	6
D5515020	Black/Blue	6
D5515050	Black/Black	6
D5515080	Black/Red	6
D55150508	Black - UV420 Blue Lens	6
D55150509	Black - Spectra Lens	6

## SPARE PARTS

CODE	PRODUCT
D2215009	STRAP LOOP SMALL FOR PRO DIVE MASKS - CLEAR (PAIR)
D2215011	STRAP LOOP SMALL FOR PRO DIVE MASKS - BLACK (PAIR)

## OPTICAL LENS

CODE	PRODUCT
D1335010	+1.0 (RIGHT) for BIG EYES EVO/QUANTUM
D1335015	+1.5 (RIGHT) for BIG EYES EVO/QUANTUM
D1335020	+2.0 (RIGHT) for BIG EYES EVO/QUANTUM
D1335025	+2.5 (RIGHT) for BIG EYES EVO/QUANTUM
D1335030	+3.0 (RIGHT) for BIG EYES EVO/QUANTUM
D1336010	-1.0 (RIGHT) for BIG EYES EVO/QUANTUM
D1336015	-1.5 (RIGHT) for BIG EYES EVO/QUANTUM
D1336020	-2.0 (RIGHT) for BIG EYES EVO/QUANTUM
D1336025	-2.5 (RIGHT) for BIG EYES EVO/QUANTUM
D1336030	-3.0 (RIGHT) for BIG EYES EVO/QUANTUM
D1336035	-3.5 (RIGHT) for BIG EYES EVO/QUANTUM
D1336040	-4.0 (RIGHT) for BIG EYES EVO/QUANTUM
D1336045	-4.5 (RIGHT) for BIG EYES EVO/QUANTUM
D1336050	-5.0 (RIGHT) for BIG EYES EVO/QUANTUM
D1336055	-5.5 (RIGHT) for BIG EYES EVO/QUANTUM
D1336060	-6.0 (RIGHT) for BIG EYES EVO/QUANTUM
D1335110	+1.0 (LEFT) for BIG EYES EVO/QUANTUM
D1335115	+1.5 (LEFT) for BIG EYES EVO/QUANTUM
D1335120	+2.0 (LEFT) for BIG EYES EVO/QUANTUM
D1335125	+2.5 (LEFT) for BIG EYES EVO/QUANTUM
D1335130	+3.0 (LEFT) for BIG EYES EVO/QUANTUM
D1336110	-1.0 (LEFT) for BIG EYES EVO/QUANTUM
D1336115	-1.5 (LEFT) for BIG EYES EVO/QUANTUM
D1336120	-2.0 (LEFT) for BIG EYES EVO/QUANTUM
D1336125	-2.5 (LEFT) for BIG EYES EVO/QUANTUM
D1336130	-3.0 (LEFT) for BIG EYES EVO/QUANTUM
D1336135	-3.5 (LEFT) for BIG EYES EVO/QUANTUM
D1336140	-4.0 (LEFT) for BIG EYES EVO/QUANTUM
D1336145	-4.5 (LEFT) for BIG EYES EVO/QUANTUM
D1336150	-5.0 (LEFT) for BIG EYES EVO/QUANTUM
D1336155	-5.5 (LEFT) for BIG EYES EVO/QUANTUM
D1336160	-6.0 (LEFT) for BIG EYES EVO/QUANTUM

### OPTICAL LENSES

POSSIBILITY OF MOUNTING OPTICAL LENSES

- CORRECTION -1.0 > -6.00

LEFT FROM  
D1336110 TO  
D1336160

RIGHT FROM  
D1336010 TO  
D1336060

- BIFOCAL LENS - CORRECTION +1.0 > +3.0

LEFT FROM  
D1335110 TO  
D1335130

RIGHT FROM  
D1335010 TO  
D1335030

**NOT SYmmETRICAL LENSES**

- The lenses are available positive for correcting nearsightedness (**myopia**).
- The lenses are available with bifocal optics for corrective farsightedness (**hyperopia**).

**INSTALLATION FEE PER SINGLE PRESCRIPTION LENS \$5.00**

COMPLETE INFORMATION OPTICAL LENSES PLEASE REFER TO PAGE 144 CHART

# NAXOS NEW 2024

NEW COMPACT ANTI-FOG SYSTEM

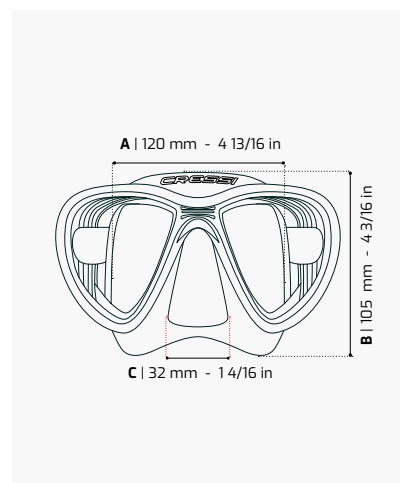

Following Cressi's patented Stop-Fog system the Naxos is the last entry-level with this innovative feature. It is compact and smaller in size than a classic diving mask, but this unique feature does not reduce the field of vision, and thanks to new internal ribs, it adapts perfectly to any anatomy of the face. Naxos, like Quantum, not only offers increased downward vision but also avoids the phenomenon of fogging by thermoregulating the warm, moist air escaping from the nose inside the mask. This is channeled by a system of membranes in the mold around the eyes and nose, which deflect the flow toward the rubber walls and not toward the glass.

On the outside of the walls is a cooling system consisting of two small heat exchangers that function like radiators. The effect is that the temperature inside the mask is lowered, bringing it closer to the outside temperature, and moisture droplets are trapped before the air reaches the glasses, thus preventing them from fogging up. The lenses are not chemically treated, so it should be remembered that when the mask is new, as is recommended for all masks, it is best to clean the lenses thoroughly with toothpaste, dishwashing detergent or simply use a lighter to burn off all volatiles and impurities deposited on the glass.



BLACK/BLACK



BLACK/YELLOW



BLACK/BLUE



CLEAR/BLUE



CLEAR/PINK



CLEAR/  
AQUAMARINE

CODE	PRODUCT	CASE PACK
D5535050	NAXOS BLACK/BLACK	6
D5535010	NAXOS BLACK/YELLOW	6
D5535020	NAXOS BLACK/BLUE	6
D5530020	NAXOS CLEAR/BLUE	6
D5530040	NAXOS CLEAR/PINK	6
D5530025	NAXOS CLEAR/AQUAMARINE	6





## INNER MEMBRANES + HEAT EXCHANGER

### INNER MEMBRANES

A patented membrane surrounding the inner nose pocket (1) and both the inner eyes pockets (2) which acts as a barrier and traps any moisture escaping from the diver's nose involuntarily when breathing through the mouth. The result is that not only is the moisture channeled away from the lenses, thus avoiding the fogging up of them, but it also reduces the need to compensate for pressure.

To further improve the anti-fog effect, Cressi suggests, the first times that the dive mask is used, to spray some anti-fog solution or to apply some saliva on the inside of the lenses and then to rinse them with water.

### HEAT EXCHANGER

The external part of the skirt features a cooling system composed of two small heat exchangers that act as radiators (3). Thanks to this system, the temperature inside mask drops, coming closer to the external temperature and the droplets of humidity are trapped before the air reaches the lenses, preventing them from fogging up.

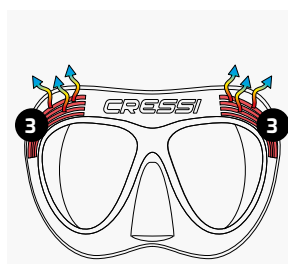
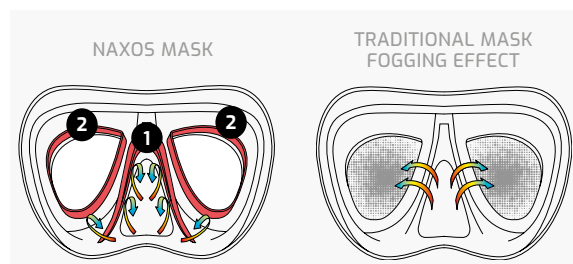

# ZEUS

NEW BUCKLE WITH LARGER BUTTON | DOUBLE INJECTION SILICONE STRAP



## TECHNICAL FEATURES

- Cressi's patent revolutionary Fog-Stop system
- U.S. PAT 6272693 B1 - Integrated dual frame technology
- Inclined lenses and slender structure optimize visibility
- Swivel buckles with micrometric adjustment
- Lenses in tempered glass
- Anatomical strap
- Strap created by double injection molding technology



## COATED LENSES

FEATURES DETAILS  
Pag 141

## TRADITIONAL MASK

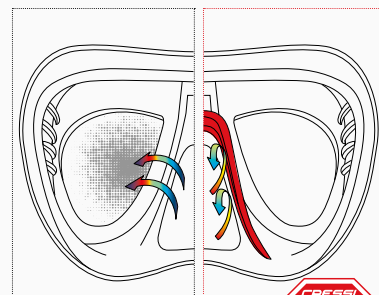

INNER NOSE POCKET -  
NEW PATENT PENDING

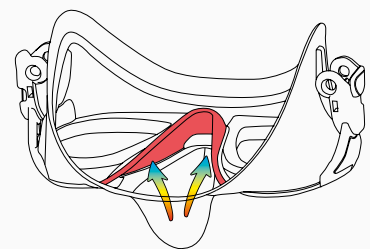

Zeus is the perfect mask for diving. This mask has a particular tapered structure deriving directly from the highly popular Nano-mask patent. The same IDF (Integrated Dual Frame Technology System) allows you to join the silicone skirt to the lens frame without

major interruptions of curvature continuity. The result is a mask with an extremely hydrodynamic shape and, visibility being equal, a significantly smaller size. The field of view obtained is particularly wide, laterally, and in the lower zone.

PRODUCT  
UPDATE

420 UV BLUE/RED  
LENSES  
HIGH ENERGY VISIBLE  
LIGHT PROTECTION



CODE	COLOR	CASE PACK
DS4750509	BLACK - UV420 BLUE LENS	6
DS475009	DARK/GOLD	6
DS475550	BLUE METAL	6
DS475050	BLACK/FRAME BLACK	6
DS475150	GREY	6
DS475058	BLACK/FRAME RED	6
DS475051	BLACK/FRAME SILVER	6
DS470020	CLEAR BLUE METAL	6
DS470040	CLEAR PINK	6
DS470050	CLEAR BLACK	6



PACKAGING





SPARE PARTS

CODE	PRODUCT
DZ215009	STRAP LOOP SMALL for PRO DIVE MASKS - CLEAR (PAIR)
DZ215011	STRAP LOOP SMALL for PRO DIVE MASKS - BLACK (PAIR)

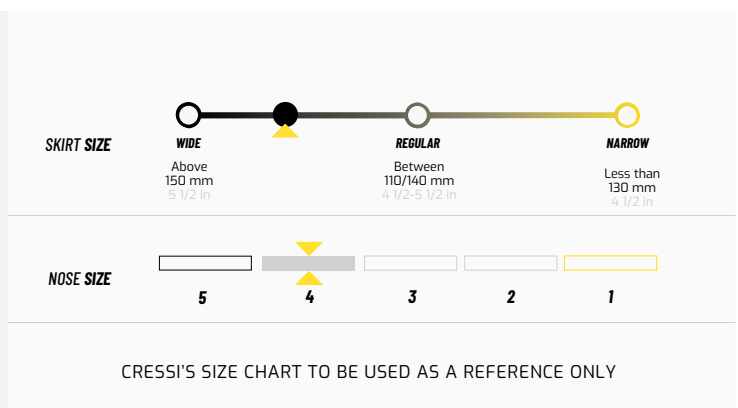
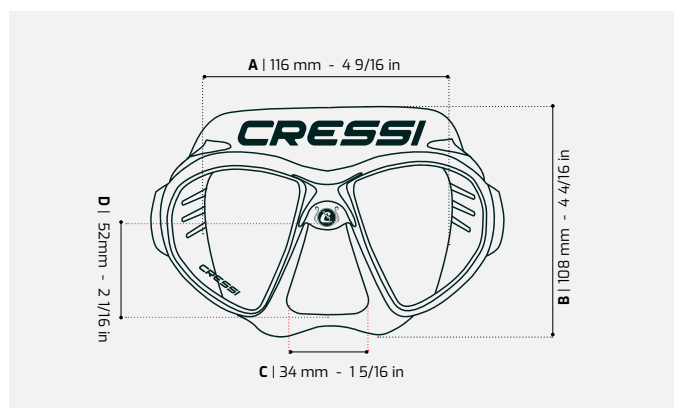



# CALIBRO

## FOG STOP SYSTEM



### TECHNICAL FEATURES

- Cressi's patented Fog-Stop system
- Integrated Dual Frame Technology
- Low volume mask
- Tempered glass lenses
- Micrometric adjustable buckle
- Flexible and swiveling buckles for a comfort fit



### COATED LENSES

FEATURES DETAILS  
Pag 141

Cressi's latest diving masks are equipped with the innovative IDF-integrated Dual Frame Technology, which offers an exceptional field of view. The mask is no exception as it boasts a hydrodynamic and compact shape along with a wide lens that remains close to the face. The mask offers a remarkable field of view due to its raked angle frame and minimal internal volume. The buckles are integrated into the

mask's rigid skirt through a sturdy rubber attachment that allows you to adjust the snorkel without shifting the mask. The mask's matte coating ensures that all its components match, preventing reflections in the water that may disturb marine life. Calibro is the ideal mask for scuba and freediving as it provides the diver with an unparalleled sense of freedom and comfort.

2024 - CATALOG



BLACK BLUE METAL CLEAR GREEN BLACK

**SPECTRA MIRRORRED LENSES**  
60% UV SEMI-REFLECTIVE

CODE	COLOR	CASE PACK
D5425050	BLACK/BLACK	6
D5425550	BLUE METAL	6
D5426000	CLEAR	6
D5426050	BLACK/BLACK - SPECTRA LENS	6
D5429850	GREEN/GREEN	6

### SPARE PARTS

CODE	PRODUCT
DZ215003	SILICONE STRAP - CLEAR
DZ215004	SILICONE STRAP - BLACK
DZ215009	STRAP LOOP SMALL FOR PRO DIVE MASKS - CLEAR (PAIR)
DZ215011	STRAP LOOP SMALL FOR PRO DIVE MASKS - BLACK (PAIR)

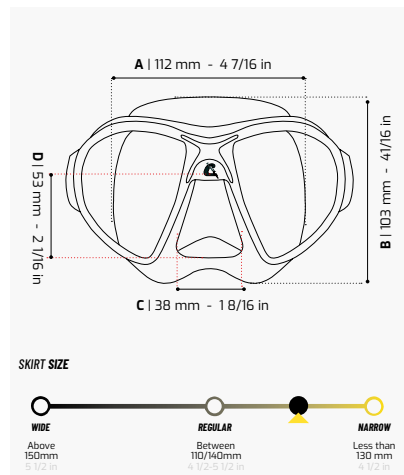

CRESSI'S SIZE CHART TO BE USED AS A REFERENCE ONLY

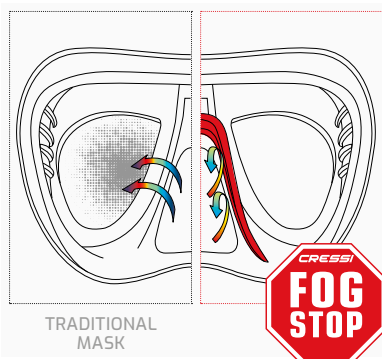

TRADITIONAL MASK



### STANDARD

### SPECTRA

SPECTRA LENS INCREASE THE VISION'S CLEARNESS BY 15%



PACKAGING

CRESSI

# A1

## ANTI-FOG SPECIAL LENS



### TECHNICAL FEATURES

- Revolutionary anti-fog coating
- Wide single-tempered glass lens
- Skirt and strap made of a soft silicone
- The top of the internal skirt features a double edge that increases drastically the sealing
- Soft nose pocket for ease of equalization
- The buckles allow for a quick and immediate adjustment of the strap length with one hand, even while wearing gloves

The A1 has been designed with an attractive style, boasting high performance for scuba diving and freediving. It boasts a single-tempered glass lens coated with anti-fog technology that is suitable for any condition. The lenses are inclined and they have an inverted teardrop shape, increasing the downward visibility. This allows better control of your scuba diving equipment. The skirt and the strap are made of soft silicone ensuring a proper fit for most shaped faces. The top of the skirt features a double edge

for a better seal. The skirt design improves water expulsion during mask clearance and minimizes water pooling. The buckles are connected to the frame with a soft and elastic flap, not only for a flexible fit but also to reduce drag and the risk of breakage. The buckles allow a quick and immediate adjustment of the strap length with one hand, even while wearing gloves. It features a soft nose pocket for ease of equalization.



### PROFILE VIEW

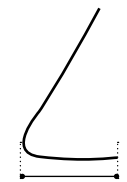

E | 23 mm - 14/16 in



BLACK/BLUE



ANTI-FOG LENS



BLACK/PINK



ANTI-FOG LENS



BLACK/GRAPHITE



ANTI-FOG LENS



WHITE/WHITE



ANTI-FOG LENS

CODE	COLOR	CASE PACK
XDN400013	A1 - BLACK/BLUE - CLEAR ANTI-FOG LENS	10
XDN400021	A1 - BLACK/PINK - CLEAR ANTI-FOG LENS	10
XDN400057	A1 - BLACK/GRAPHITE - CLEAR ANTI-FOG LENS	10
XDN400061	A1 - WHITE/WHITE - CLEAR ANTI-FOG LENS	10

### SPARE PARTS

CODE	PRODUCT
DZ222050	STRAP for SCUBA MASK TW - BLACK
DZ222030	STRAP for SCUBA MASK TW - WHITE
DZ221050	BUCKLES for SCUBA MASK TW - BLACK/BLACK
DZ221030	BUCKLES for SCUBA MASK TW - WHITE/CLEAR



### PRODUCT DIMENSION CHART (SKIRT SIZE)

A - WIDTH	B - HEIGHT	C - NOSE LENGTH	D - NOSE HEIGHT	E - NOSE WIDTH
130 mm	118 mm	36 mm	48 mm	23 mm
5 2/16 in	4 10/16 in	1 7/16 in	1 14/16 in	14/16 in

CRESSI'S SIZE CHART IS TO BE USED AS A REFERENCE ONLY

**CLEAR VIEW  
ON EVERY  
DIVE!  
INCLUDING  
THE FIRST**



### COATED LENSES

FEATURES DETAILS  
Pag 141

Cressi's Anti Fog Lens Coating Technology is a new, innovative method to allow the snorkeler or the diver to enjoy the mask right from the beginning. The new Anti Fog lens is possible thanks to an exclusive coating method based on an invisible film that attaches to the lens during the mask production.



PACKAGING

# NANO & NANO CRYSTAL

85 CM3: ULTRA LOW VOLUME



**TECHNICAL FEATURES**

- Internal volume just 85 cm<sup>3</sup> | 5.2 cu in
- Reduced lens-face distance
- Inclined lenses and slender structure optimize visibility
- Swivel buckles with micrometric adjustment
- Lenses in tempered glass
- Anatomical strap



## GRESSI crystal®

**THE SILICONE REVOLUTION**  
 CRYSTAL silicone® is an exclusive GRESSI material that revolutionizes swim mask skirt clarity. It offers incredibly clear vision and features long-lasting advanced technology components within the pure silicone skirt which prevents premature discoloration, reduces fogging, and guarantees many years of CRYSTAL clear viewing.



**SPECTRA MIRRORED LENSES**  
 60% UV SEMI-REFLECTIVE



SPECTRA LENS INCREASE THE VISION'S CLEARNESS BY 15%

This mask has a tapered structure that is derived from the popular Nano-mask patent. The IDF-Integrated Dual Frame technology system connects the silicone skirt to the lens frame without any interruptions in curvature continuity. This results in a much smaller mask with an extremely hydrodynamic shape, while still maintaining the same level of visibility. The Inclined Lens Patented Technology provides a wide field of view that extends laterally and in the lower zone. The front part of the skirt

has a structural silicone insert that enhances the mask's sealing ability and creates an aesthetically pleasing chromatic effect. It is specifically designed for advanced divers, freediving, and spearfishing enthusiasts who require an extremely hydrodynamic and compact mask that facilitates diving. The Crystal silicone is a patented formula for the skirt which prevents premature discoloration and it's softer.

**COATED LENSES**  
 FEATURES DETAILS  
 Pag 141



CODE	PRODUCT	CASE PACK
D5360010	NANO CRYSTAL - CLEAR/YELLOW	6
D5360020	NANO CRYSTAL - CLEAR/BLUE	6
D5360040	NANO CRYSTAL - CLEAR/PINK	6
D5360041	NANO CRYSTAL - CLEAR/LILAC	6
D5360060	NANO CRYSTAL - CLEAR/WHITE	6
D5365050	NANO - BLACK/BLACK	6
D5365550	NANO - BLUE/BLACK METAL	6
D5366050	NANO - BLACK/BLACK - SPECTRA LENS	6
D5369850	NANO - GREEN/GREEN	6





CRESSI PATENTED TECHNOLOGIES

★ **INCLINED GLASSES**  
US 6272693 B1

Cressi has developed and patented in 2001 a particular mask frame that to solve the problem of the divers not being able to easily see the scuba equipment. A scuba diver carrying many different pieces of equipment, some of them are vital like the pressure and depth gauges. The solution has been found designing a new frame shape that is inclined downwards. Moreover, the shape of the lens is designed like an inverted teardrop increasing drastically the downward visibility.



★ **INTEGRATED BUCKLES**  
US 8281417 B2

The patented technology is to provide a mask for aquatic activities that avoid loss of watertight during strap-tightening by a diver when the mask is in use underwater. The object of the invention is to avoid exertion of a tensile force or stress during mask adjustment and, in turn, rupture of the skirt. The buckles are not directly fixed

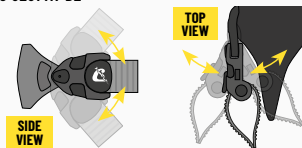

to the frame but anchored to the rubber of the skirt, allowing it to freely swivel and pivot in all directions. The buckles are joined with lateral sides of the frame by brackets extending from the lateral sides. The brackets are made of a selected flexible material. This features facilitates the mask storage when not in use.

★ **INTEGRATED DUAL FRAME**  
US 20140013494 A1

The Patented Integrated Dual Frame Technology consists of the joining of two rigid frames, the first on the rear of the silicone skirt and the second, anterior to the first one, that support the lenses. When the two frames are joined and locked together, the silicone skirt remains locked in the middle to guarantee a perfect seal between the face piece and the lens. This technology produces a drastic reduction in the internal volume, while keeping the lenses close to the eyes to ensure a wide view laterally and in the lower zone. The result is a mask with an extremely hydrodynamic shape and low volume.



SPARE PARTS

CODE	PRODUCT
DZ215002	SILICONE STRAP - SILVER for CRYSTAL MASKS
DZ215003	SILICONE STRAP - CLEAR for ITALIAN SCUBA MASK
DZ215004	SILICONE STRAP - BLACK for ITALIAN SCUBA MASK
DZ210021	BUCKLES - BLACK for AIR/BIG EYES EVO/EYES EVO/NANO/OCCHIO P.
DZ215009	STRAP LOOP SMALL for PRO DIVE MASKS - CLEAR (PAIR)
DZ215011	STRAP LOOP SMALL for PRO DIVE MASKS - BLACK (PAIR)

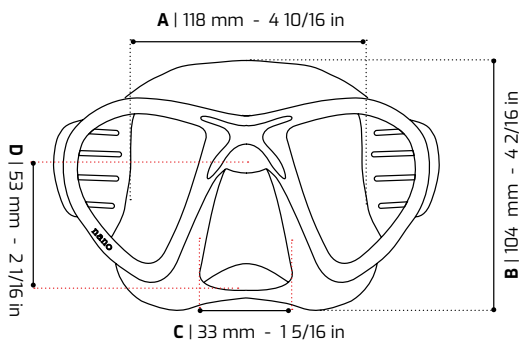

PROFILE VIEW

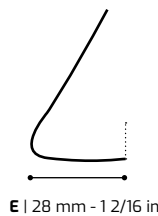

PRODUCT DIMENSION CHART (SKIRT SIZE)

A - WIDTH	B - HEIGHT	C - NOSE LENGTH	D - NOSE HEIGHT	E - NOSE WIDTH
118 mm 4 10/16 in	104 mm 4 2/16 in	33 mm 1 5/16 in	53 mm 2 1/16 in	28 mm 1 2/16 in

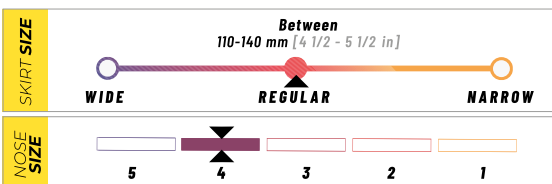

CRESSI'S SIZE CHART IS TO BE USED AS A REFERENCE ONLY  
++ Measure ear to ear with a ruler

# BIG EYES EVOLUTION CRYSTAL

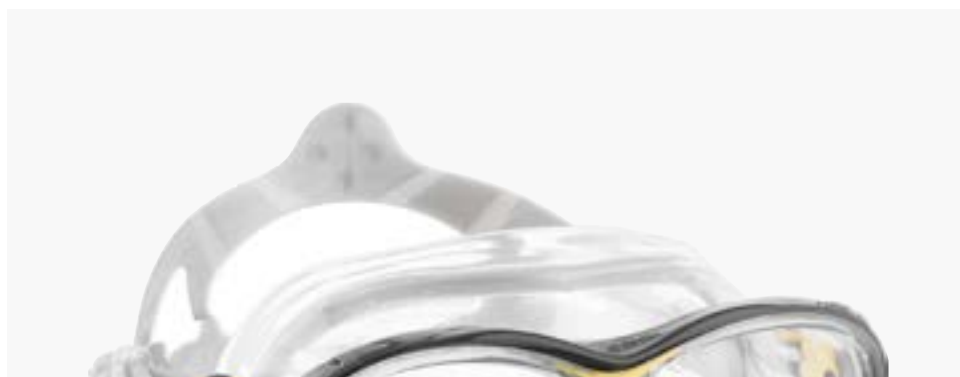

The ultimate in comfort and performance, the Big Eyes Evolution Crystal combines the best of Cressi technology.

Raked lenses, with Cressi's inverted tear-drop shape, are placed close to the eyes for an exceptional field of view, and the Crystal Silicone skirt delivers excellent light transmission while resisting discoloration and fogging. The Crystal Silicone skirt also seals gently against the skin with a very open angle that accommodates a wide range of facial shapes.

## TECHNICAL FEATURES

- Extremely hydrodynamic and compact design
- Internal volume just 85 cm<sup>3</sup>
- Reduced lens-face distance
- Angle lenses and slender structure optimize visibility
- Swivel buckles with micrometric adjustment
- Lenses in tempered glass
- Anatomical strap

## OPTICAL LENSES POSSIBILITY OF MOUNTING OPTICAL LENSES

- CORRECTION -1.0 > -6.00



LEFT FROM  
D1336110 TO  
D1336160

RIGHT FROM  
D1336010 TO  
D1336060



- BIFOCAL LENS - CORRECTION +1.0 > +3.0



LEFT FROM  
D1335110 TO  
D1335190

RIGHT FROM  
D1335010 TO  
D1335030



### NOT SYMMETRICAL LENSES

- The lenses are available positive for correcting nearsightedness (**myopia**).
- The lenses are available with bifocal optics for corrective farsightedness (**hyperopia**).

INSTALLATION FEE PER SINGLE PRESCRIPTION LENS  
**\$5.00**

COMPLETE INFORMATION OPTICAL LENSES  
PLEASE REFER TO PAGE 144 CHART



YELLOW/BLACK

BLUE/BLACK

WHITE/PINK



BLACK

WHITE/BLUE

## CRESSI crystal®

### THE SILICONE REVOLUTION

CRYSTAL silicone® is an exclusive CRESSI material that revolutionizes swim mask skirt clarity. It offers incredibly clear vision and features long-lasting advanced technology components within the pure silicone skirt which prevents premature discoloration, reduces fogging, and guarantees many years of CRYSTAL clear viewing.



PACKAGING

CODE	COLOR	CASE PACK
DS340010	Yellow/Black	6
DS340025	Blue/Black	6
DS340040	White/Pink	6
DS340060	Black	6
DS340062	White/Blue	6

SPARE PARTS

CODE	PRODUCT
DZ215003	SILICONE STRAP - CLEAR for ITALIAN SCUBA MASK
DZ215004	SILICONE STRAP - BLACK for ITALIAN SCUBA MASK
DZ210021	BUCKLES - BLACK for AIR/BIG EYES EVO/EYES EVO/NANO/OCCHIO P.
DZ215009	STRAP LOOP SMALL for PRO DIVE MASKS - CLEAR (PAIR)
DZ215011	STRAP LOOP SMALL for PRO DIVE MASKS - BLACK (PAIR)

OPTICAL LENS

CODE	PRODUCT
D1335010	+1.0 (RIGHT) for BIG EYES EVO/QUANTUM
D1335015	+1.5 (RIGHT) for BIG EYES EVO/QUANTUM
D1335020	+2.0 (RIGHT) for BIG EYES EVO/QUANTUM
D1335025	+2.5 (RIGHT) for BIG EYES EVO/QUANTUM
D1335030	+3.0 (RIGHT) for BIG EYES EVO/QUANTUM
D1336010	-1.0 (RIGHT) for BIG EYES EVO/QUANTUM
D1336015	-1.5 (RIGHT) for BIG EYES EVO/QUANTUM
D1336020	-2.0 (RIGHT) for BIG EYES EVO/QUANTUM
D1336025	-2.5 (RIGHT) for BIG EYES EVO/QUANTUM
D1336030	-3.0 (RIGHT) for BIG EYES EVO/QUANTUM
D1336035	-3.5 (RIGHT) for BIG EYES EVO/QUANTUM
D1336040	-4.0 (RIGHT) for BIG EYES EVO/QUANTUM
D1336045	-4.5 (RIGHT) for BIG EYES EVO/QUANTUM
D1336050	-5.0 (RIGHT) for BIG EYES EVO/QUANTUM
D1336055	-5.5 (RIGHT) for BIG EYES EVO/QUANTUM
D1336060	-6.0 (RIGHT) for BIG EYES EVO/QUANTUM
D1335110	+1.0 (LEFT) for BIG EYES EVO/QUANTUM
D1335115	+1.5 (LEFT) for BIG EYES EVO/QUANTUM
D1335120	+2.0 (LEFT) for BIG EYES EVO/QUANTUM
D1335125	+2.5 (LEFT) for BIG EYES EVO/QUANTUM
D1335130	+3.0 (LEFT) for BIG EYES EVO/QUANTUM
D1336110	-1.0 (LEFT) for BIG EYES EVO/QUANTUM
D1336115	-1.5 (LEFT) for BIG EYES EVO/QUANTUM
D1336120	-2.0 (LEFT) for BIG EYES EVO/QUANTUM
D1336125	-2.5 (LEFT) for BIG EYES EVO/QUANTUM
D1336130	-3.0 (LEFT) for BIG EYES EVO/QUANTUM
D1336135	-3.5 (LEFT) for BIG EYES EVO/QUANTUM
D1336140	-4.0 (LEFT) for BIG EYES EVO/QUANTUM
D1336145	-4.5 (LEFT) for BIG EYES EVO/QUANTUM
D1336150	-5.0 (LEFT) for BIG EYES EVO/QUANTUM
D1336155	-5.5 (LEFT) for BIG EYES EVO/QUANTUM
D1336160	-6.0 (LEFT) for BIG EYES EVO/QUANTUM

CRESSI PATENTED TECHNOLOGIES

★ INCLINED GLASSES  
US 8272693 B1

Cressi has developed and patented in 2001 a particular mask frame that to solve the problem of the divers not being able to easily see the scuba equipment. A scuba diver carrying many different pieces of equipment, some of them are vital like the pressure and depth gauges. The solution has been found designing a new frame shape that is inclined downwards. Moreover, the shape of the lens is designed like an inverted teardrop increasing drastically the downward visibility.



★ INTEGRATED BUCKLES  
US 8281417 B2

The patented technology is to provide a mask for aquatic activities that avoid loss of watertight during strap-tightening by a diver when the mask is in use underwater. The object of the invention is to avoid exertion of a tensile force or stress during mask adjustment and, in turn, rupture of the skirt. The buckles are not directly fixed

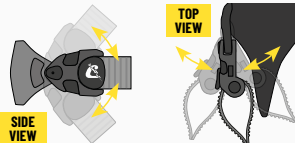

to the frame but anchored to the rubber of the skirt, allowing it to freely swivel and pivot in all directions. The buckles are joined with lateral sides of the frame by brackets extending from the lateral sides. The brackets are made of a selected flexible material. This features facilitates the mask storage when not in use.

★ INTEGRATED DUAL FRAME  
US 20140013494 A1

The Patented Integrated Dual Frame Technology consists of the joining of two rigid frames, the first on the rear of the silicone skirt and the second, anterior to the first one, that support the lenses. When the two frames are joined and locked together, the silicone skirt remains locked in the middle to guarantee a perfect seal between the face piece and the lens. This technology produces a drastic reduction in the internal volume, while keeping the lenses close to the eyes to ensure a wide view laterally and in the lower zone. The result is a mask with an extremely hydrodynamic shape and low volume.

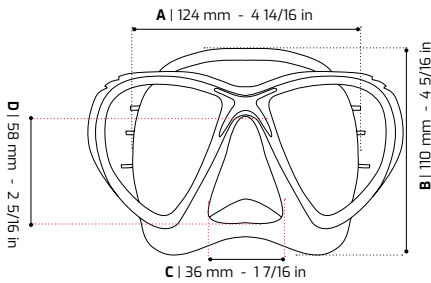

PROFILE VIEW

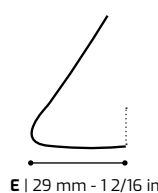

PRODUCT DIMENSION CHART (SKIRT SIZE)

A - WIDTH	B - HEIGHT	C - NOSE LENGTH	D - NOSE HEIGHT	E - NOSE WIDTH
124 mm 4 14/16 in	110 mm 4 5/16 in	36 mm 1 7/16 in	58 mm 2 5/16 in	29 mm 1 2/16 in

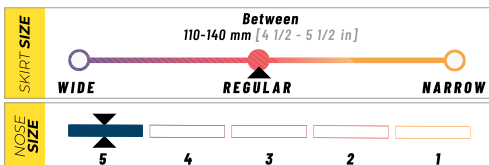

Cressi's Size Chart is to be used as a reference only  
++ Measure ear to ear with a ruler



# AIR

## NEW IDF TECHNOLOGY INTEGRATED DUAL FRAME

CRYSTAL  
BLACK/YELLOW

BLACK/YELLOW



BLACK/BLACK

CRYSTAL  
BLACK/BLUE

BLACK/BLUE



BLUE METAL

This mask has a particular tapered structure deriving directly from the highly popular Nano-mask patent. The Dual Integrated Frame Technology System allows you to join the silicone skirt to the lens frame without major interruptions of the curvature continuity. The result is a mask with an extremely hydrodynamic shape and, visibility being equal, a significantly smaller size. Mask features inclined and inverted tear-drop lenses for improve downward visibility, a Cressi patented design (US 6272693). The field of view obtained is particularly wide, laterally and in the lower zone. The lenses are made in tempered glass. The skirt is made with top quality Crystal Silicone™, a Cressi trademark formula to avoid yellowing after years. In the front part, the skirt has a structural silicone insert which increases the sealing ability of the mask and creates an exceptionally pleasant chromatic play. Easy-to-use buckles for quickly strap length adjustment. The mask comes with a protective plastic PVC case.

### TECHNICAL FEATURES

- Double injection technology
- Flexible buckle



PACKAGING

CODE	COLOR	CASE PACK
D5400010	AIR CRYSTAL - BLACK/YELLOW	6
D5400062	AIR CRYSTAL - BLACK/BLUE	6
D5405010	AIR BLACK - BLACK/YELLOW	6
D5405050	AIR BLACK - BLACK/BLACK	6
D5405062	AIR BLACK - BLACK/BLUE	6
D5405550	AIR - BLUE METAL	6

### SPARE PARTS

CODE	PRODUCT
DZ215002	SILICONE STRAP - SILVER for CRYSTAL MASKS
DZ210021	BUCKLES - BLACK for AIR/BIG EYES EVO/EYES EVO/NANO/OCCHIO P.
DZ215009	STRAP LOOP SMALL for PRO DIVE MASKS - CLEAR (PAIR)



CRESSI PATENTED TECHNOLOGIES

★ **INCLINED GLASSES**  
US 6272693 B1

Cressi has developed and patented in 2001 a particular mask frame that to solve the problem of the divers not being able to easily see the scuba equipment. A scuba diver carrying many different pieces of equipment, some of them are vital like the pressure and depth gauges. The solution has been found designing a new frame shape that is inclined downwards. Moreover, the shape of the lens is designed like an inverted teardrop increasing drastically the downward visibility.



★ **INTEGRATED BUCKLES**  
US 8281417 B2

The patented technology is to provide a mask for aquatic activities that avoid loss of watertight during strap-tightening by a diver when the mask is in use underwater. The object of the invention is to avoid exertion of a tensile force or stress during mask adjustment and, in turn, rupture of the skirt. The buckles are not directly fixed

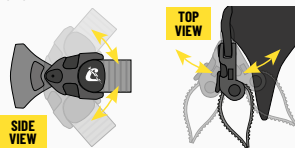

to the frame but anchored to the rubber of the skirt, allowing it to freely swivel and pivot in all directions. The buckles are joined with lateral sides of the frame by brackets extending from the lateral sides. The brackets are made of a selected flexible material. This feature facilitates the mask storage when not in use.

★ **INTEGRATED DUAL FRAME**  
US 20140013494 A1

The Patented Integrated Dual Frame Technology consists of the joining of two rigid frames, the first on the rear of the silicone skirt and the second, anterior to the first one, that support the lenses. When the two frames are joined and locked together, the silicone skirt remains locked in the middle to guarantee a perfect seal between the face piece and the lens. This technology produces a drastic reduction in the internal volume, while keeping the lenses close to the eyes to ensure a wide view laterally and in the lower zone. The result is a mask with an extremely hydrodynamic shape and low volume.

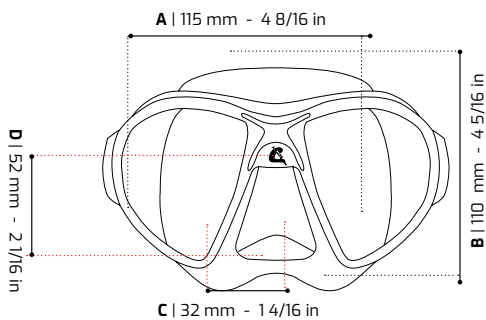

PROFILE VIEW

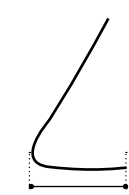

E | 28 mm - 1 2/16 in



PRODUCT DIMENSION CHART (SKIRT SIZE)

A - WIDTH	B - HEIGHT	C - NOSE LENGTH	D - NOSE HEIGHT	E - NOSE WIDTH
115 mm 4 8/16 in	110 mm 4 5/16 in	32 mm 1 4/16 in	52 mm 2 1/16 in	28 mm 1 2/16 in

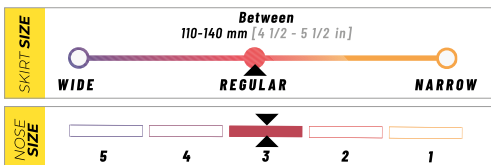

Cressi's Size Chart is to be used as a reference only  
++ Measure ear to ear with a ruler



# BIG EYES EVOLUTION

## OUTSTANDING FIELD OF VIEW



The Big Eyes Evolution's signature inverted tear-drop lenses are raked inward and provide outstanding field of view with very low internal volume. A redesigned skirt now uses internal ribs to provide the ultimate in fit and support. Fully flexible, easy to adjust buckles are attached using Cressi's double injection molding technology for both comfort and extreme durability.

### TECHNICAL FEATURES

- Raked lenses provide excellent field-of-view
- Inverted tear-drop lenses improve downward visibility for managing BC-mounted gear
- Low internal volume allows for effortless clearing
- Dual-density silicone skirt flexes for a perfect seal along the face and full support around the frame
- Ribbed facial skirt provides support where needed for a soft, flexible fit
- Micrometric adjustable buckles allow precise headband adjustments
- Swiveling buckles connect to flexible, indestructible elastomer tabs for total durability and comfort.
- Accepts optical lenses.

### OPTICAL LENSES POSSIBILITY OF MOUNTING OPTICAL LENSES

- CORRECTION -1.0 > -6.00
  - LEFT FROM D1336110 TO D1336160
  - RIGHT FROM D1336010 TO D1336060
- BIFOCAL LENS - CORRECTION +1.0 > +3.0
  - LEFT FROM D1335110 TO D1335130
  - RIGHT FROM D1335010 TO D1335030

- NOT SYMMETRICAL LENSES**
- The lenses are available positive for correcting nearsightedness (**myopia**).
  - The lenses are available with bifocal optics for corrective farsightedness (**hyperopia**).

**INSTALLATION FEE PER SINGLE PRESCRIPTION LENS \$5.00**

Complete information optical lenses please refer to page 144 chart

CODE	PRODUCT
D1335010	+1.0 (RIGHT) for BIG EYES EVO/QUANTUM
D1335015	+1.5 (RIGHT) for BIG EYES EVO/QUANTUM
D1335020	+2.0 (RIGHT) for BIG EYES EVO/QUANTUM
D1335025	+2.5 (RIGHT) for BIG EYES EVO/QUANTUM
D1335030	+3.0 (RIGHT) for BIG EYES EVO/QUANTUM
D1336010	- 1.0 (RIGHT) for BIG EYES EVO/QUANTUM
D1336015	- 1.5 (RIGHT) for BIG EYES EVO/QUANTUM
D1336020	- 2.0 (RIGHT) for BIG EYES EVO/QUANTUM
D1336025	- 2.5 (RIGHT) for BIG EYES EVO/QUANTUM
D1336030	- 3.0 (RIGHT) for BIG EYES EVO/QUANTUM
D1336035	- 3.5 (RIGHT) for BIG EYES EVO/QUANTUM
D1336040	- 4.0 (RIGHT) for BIG EYES EVO/QUANTUM
D1336045	- 4.5 (RIGHT) for BIG EYES EVO/QUANTUM
D1336050	- 5.0 (RIGHT) for BIG EYES EVO/QUANTUM
D1336055	- 5.5 (RIGHT) for BIG EYES EVO/QUANTUM
D1336060	- 6.0 (RIGHT) for BIG EYES EVO/QUANTUM
D1335110	+1.0 (LEFT) for BIG EYES EVO/QUANTUM
D1335115	+1.5 (LEFT) for BIG EYES EVO/QUANTUM
D1335120	+2.0 (LEFT) for BIG EYES EVO/QUANTUM
D1335125	+2.5 (LEFT) for BIG EYES EVO/QUANTUM
D1335130	+3.0 (LEFT) for BIG EYES EVO/QUANTUM
D1336110	- 1.0 (LEFT) for BIG EYES EVO/QUANTUM
D1336115	- 1.5 (LEFT) for BIG EYES EVO/QUANTUM
D1336120	- 2.0 (LEFT) for BIG EYES EVO/QUANTUM
D1336125	- 2.5 (LEFT) for BIG EYES EVO/QUANTUM
D1336130	- 3.0 (LEFT) for BIG EYES EVO/QUANTUM
D1336135	- 3.5 (LEFT) for BIG EYES EVO/QUANTUM
D1336140	- 4.0 (LEFT) for BIG EYES EVO/QUANTUM
D1336145	- 4.5 (LEFT) for BIG EYES EVO/QUANTUM
D1336150	- 5.0 (LEFT) for BIG EYES EVO/QUANTUM
D1336155	- 5.5 (LEFT) for BIG EYES EVO/QUANTUM
D1336160	- 6.0 (LEFT) for BIG EYES EVO/QUANTUM



CODE	COLOR	CASE PACK
D5336010	Clear/Yellow	6
D5336020	Clear/Blue	6
D5336040	Clear/Pink	6
D5336060	Clear/Black	6
D5336080	Clear/Red	6
D5336510	Black/Yellow	6
D5336520	Black/Blue	6
D5336550	Black/Black	6
D5336950	Black/Black, Spectra Lens	6

### SPARE PARTS

CODE	PRODUCT
D2215003	SILICONE STRAP - CLEAR for ITALIAN SCUBA MASK
D2215004	SILICONE STRAP - BLACK for ITALIAN SCUBA MASK
D2210021	BUCKLES - BLACK for AIR/BIG EYES EVO/EYES EVO/NANO/OCCHIO P.
D2215009	STRAP LOOP SMALL for PRO DIVE MASKS - CLEAR (PAIR)
D2215011	STRAP LOOP SMALL for PRO DIVE MASKS - BLACK (PAIR)

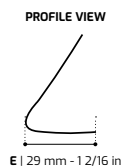
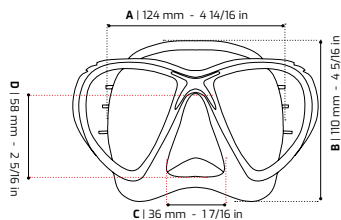

### PRODUCT DIMENSION CHART (SKIRT SIZE)

A - WIDTH	B - HEIGHT	C - NOSE LENGTH	D - NOSE HEIGHT	E - NOSE WIDTH
124 mm	110 mm	36 mm	58 mm	29 mm
4 14/16 in	4 5/16 in	1 7/16 in	2 5/16 in	1 2/16 in

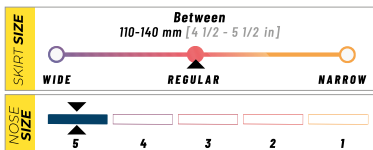

Cressi's Size Chart is to be used as a reference only  
++ Measure ear to ear with a ruler

**COATED LENSES**

FEATURES DETAILS  
Pag 141



SPECTRA LENS INCREASE THE VISION'S CLEARNESS BY 15%



PACKAGING



# SF1

## SQUARED FRAMELESS DIVE MASK

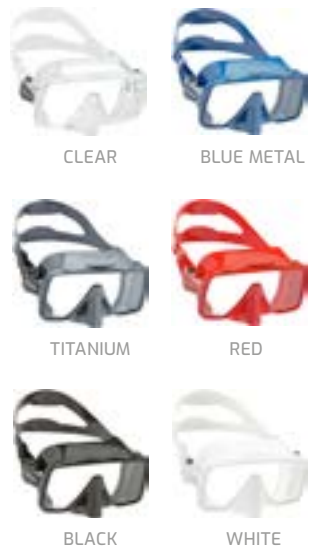

### TECHNICAL FEATURES

- Cressi frameless technology
- Micrometric adjustable buckle
- Tempered glass
- Ultra low-volume, single lens design for excellent field-of-view
- Silicone skirt bonds directly to the lens for lower weight and reduced drag
- Quick adjustable buckles mounted on the skirt
- High-quality flexible silicone that gently and securely adheres to the face

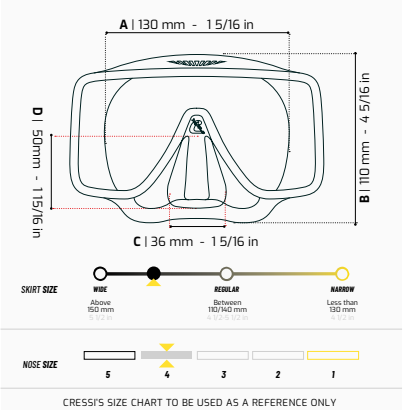

CRESSI'S SIZE CHART TO BE USED AS A REFERENCE ONLY



PACKAGING

The SF1 is the new 2020 frameless scuba diving unisex mask. The frameless masks are loved by many divers for their low profile and ability to fold flat for easy carrying, even in a BCD pocket. The silicone face is assembled directly on the glass without mounting. This system guarantees good visibility in all directions, especially towards the sides, since it allows a maximum eye/lens approach without annoying pressure on the forehead or upper part of the nose. The low-internal volume allows for effortless clearing and quickadjust strap buckles are molded directly into the skirt for a flexible fit and reduced drag. It also represents an unbeatable value, with a cost roughly half that of similar masks.

CODE	PRODUCT	CASE PACK
ZDN331000	SF1 - CLEAR	30
ZDN331020	SF1 - BLUE	30
ZDN331051	SF1 - TITANIUM	30
ZDN331058	SF1 - RED	30
ZDN332000	SF1 - BLACK	30
ZDN333000	SF1 - WHITE	30

### SPARE PARTS

CODE	PRODUCT
DZ222020	STRAP for SCUBA MASK TW - BLUE
DZ222030	STRAP for SCUBA MASK TW - WHITE
DZ222050	STRAP for SCUBA MASK TW - BLACK
DZ222051	STRAP for SCUBA MASK TW - SILVER
DZ222080	STRAP for SCUBA MASK TW - RED
DZ221030	BUCKLES for SCUBA MASK TW - WHITE/CLEAR
DZ221050	BUCKLES for SCUBA MASK TW - BLACK/BLACK
DZ215014	STRAP LOOP for SCUBA MASK TW - CLEAR (PAIR)



# F-DUAL

## MONO-LENS FRAMELESS DIVE MASK



The F-Dual is a single-lens mask featuring a unique assembly of lens and skirt without a frame. The mask design bonds a high-grade silicone double-feathered edge skirt directly to a single tempered glass lens for the ultimate in simplicity. The silicone facial is assembled directly on the glass without the need for a frame. This system guarantees good visibility

in all directions. The low internal volume allows for effortless clearing and the quick-adjust strap buckles are molded directly into the skirt for a flexible fit and reduced drag. The F-Dual mask has a wide split strap design for comfort and to give even-tension on the skirt for a proper seal.



CODE	COLOR	CASE PACK
D5500010	CLEAR/YELLOW	30
D5500020	CLEAR/BLUE	30
D5500050	CLEAR/BLACK	30
<b>NEW</b> D5502020	BLUE NAVY	30
D5505020	BLACK/BLUE	30
D5505080	BLACK/RED	30
<b>NEW</b> D5505951	BLACK/BLACK - UV420 YELLOW LENS	30
<b>NEW</b> D5505952	BLACK/BLACK - UV420 BLUE LENS	30

### SPARE PARTS

CODE	PRODUCT
D2222000	STRAP for SCUBA MASK TW - CLEAR
D2222050	STRAP for SCUBA MASK TW - BLACK
D2221030	BUCKLES for SCUBA MASK TW - WHITE/CLEAR
D2221050	BUCKLES for SCUBA MASK TW - BLACK/BLACK
D2215014	STRAP LOOP for SCUBA MASK TW - CLEAR (PAIR)

### TECHNICAL FEATURES

- Frameless technology for maximum comfort
- Single tempered glass lens
- Wide field of view
- High-grade soft silicone
- Double feathered edge skirt
- Quick-adjustable strap buckles
- Easy-access nose pocket for 1-handed ear equalization the face

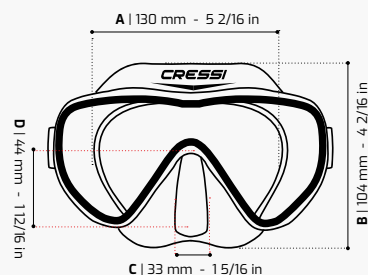

### PROFILE VIEW



### SKIRT SIZE



### NOSE SIZE



CRESSI'S SIZE CHART TO BE USED AS A REFERENCE ONLY



### COATED LENSES

FEATURES DETAILS  
Pag 141



PACKAGING

# LIBERTY

OUTSTANDING FIELD OF VIEW | WITH ANTI-FOG CONFIGURATIONS AVAILABLE



It gives the diver a wide, unobstructed field of vision while snorkeling or scuba diving. It features one large lens to offer divers a phenomenal field of vision. The lens is made of tempered glass for safety. The skirt is made of hypoallergenic soft silicone, anatomically designed, to ensure a perfect seal. The mask is equipped with easy-to-use buckles for immediate

length strap adjustment. The mask has an easy-to-reach, one-hand nose pocket for ear equalization, which can be utilized even when wearing thick gloves. The double-feathered edge silicone skirt works in concert with the split strap for an excellent seal on the face. The exclusive painted, coated frame brings a cool tech design style.



CODE	COLOR	CASE PACK
NEW DS390120	LIBERTY - CLEAR/BLUE	30
NEW DS395120	LIBERTY - BLACK/BLUE	30
DS395050	LIBERTY SPE - BLACK/BLACK	30
NEW DS390059	LIBERTY - CLEAR/BLACK-CLEAR ANTI-FOG LENS	30
NEW DS395550	LIBERTY - BLACK/BLACK-CLEAR ANTI-FOG LENS	30

#### SPARE PARTS

CODE	PRODUCT
DZ222000	Strap for Scuba Mask TW - Clear
DZ222050	Strap for Scuba Mask TW - Black
DZ221030	Buckles for Scuba Mask TW - White/Clear
DZ221050	Buckles for Scuba Mask TW - Black/Black
DZ215012	Strap loop for Scuba Mask TW - Black (pair)
DZ215014	Strap loop for Scuba Mask TW - Clear (pair)

#### TECHNICAL FEATURES

- Wide single-tempered glass lens
- Wide field of view
- High-grade soft silicone
- Double feathered edge skirt
- Quick-adjustable strap buckles
- Easy-access nose pocket for 1-handed ear equalization

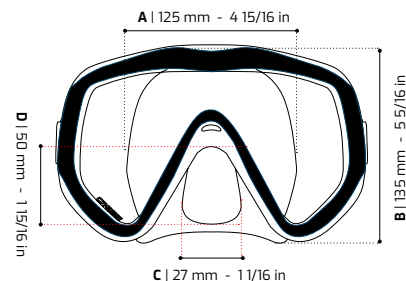

#### PROFILE VIEW

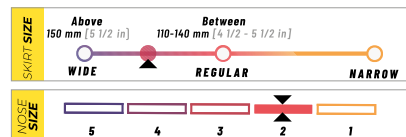
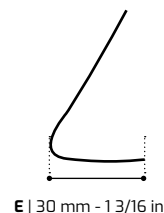

#### PRODUCT DIMENSION CHART (SKIRT SIZE)

A - WIDTH	B - HEIGHT	C - NOSE LENGTH	D - NOSE HEIGHT	E - NOSE WIDTH
125 mm	135 mm	27 mm	50 mm	30 mm
4 15/16 in	5 5/16 in	1 1/16 in	1 15/16 in	1 3/16 in

CRESSI'S SIZE CHART IS TO BE USED AS A REFERENCE ONLY



#### COATED LENSES

FEATURES DETAILS  
Pag 141



PACKAGING



# LIBERTY DUO NEW COLOR 2024



## TECHNICAL FEATURES

- Inverted teardrop shape lenses
- Tempered glass lenses
- Micrometric adjustable buckle
- Flexible buckle
- Skirt and strap made of high-grade silicone

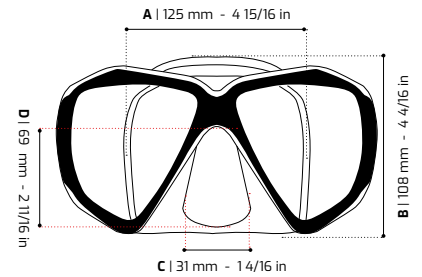

### PROFILE VIEW

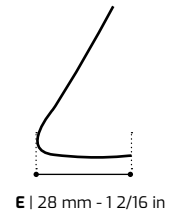

The Liberty Duo is a diving mask that features 2 big inverted teardrop lenses to ensure a complete view of equipment with reasonable internal volume for better clearing and a lower profile in the water. All lenses are tempered glass for the best clarity and are joined in a way that minimizes the visible seam. An excellent choice for both diving and snorkeling, it provides both improved vision and comfort over previous multi-lens masks. The skirt and the strap are made with hypoallergenic silicone to ensure comfort and a perfect fit. The buckles allow an immediate adjustment of the length strap with one hand, even while wearing gloves.

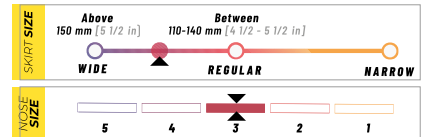

## PRODUCT DIMENSION CHART (SKIRT SIZE)

A - WIDTH	B - HEIGHT	C - NOSE LENGTH	D - NOSE HEIGHT	E - NOSE WIDTH
125 mm 4 15/16 in	108 mm 4 4/16 in	31 mm 1 4/16 in	69 mm 2 11/16 in	28 mm 1 2/16 in

CRESSI'S SIZE CHART IS TO BE USED AS A REFERENCE ONLY



BLACK/  
BLUE



BLACK/  
BLUE/SILVER



WHITE/  
TURQUOISE



BLACK/TITANIUM  
**ANTI-FOG LENS**



BLACK

**YELLOW/BLUE LENSES**  
80% UV-ANTI GLARE

CODE	COLOR	CASE PACK
DS445020	LIBERTY DUO SPE - BLACK-BLUE/BLUE	30
DS445025	LIBERTY DUO SPE - BLACK-BLUE/SILVER	30
<b>NEW</b> DS445020	LIBERTY DUO - BLACK/YELLOW	30
<b>NEW</b> DS443028	LIBERTY DUO - WHITE/TURQUOISE	30
<b>NEW</b> DS445250	LIBERTY DUO - BLACK/BLACK-UV420 YELLOW LENS	30
<b>NEW</b> DS445155	LIBERTY DUO - BLACK/TITANIUM-ANTI-FOG LENS	30

### SPARE PARTS

CODE	PRODUCT
DZ222000	Strap for Scuba Mask TW - Clear
DZ222050	Strap for Scuba Mask TW - Black
DZ221030	Buckles for Scuba Mask TW - White/Clear
DZ221050	Buckles for Scuba Mask TW - Black/Black
DZ215012	Strap loop for Scuba Mask TW - Black (pair)
DZ215014	Strap loop for Scuba Mask TW - Clear (pair)

**COATED LENSES**

FEATURES DETAILS  
Pag 141



PACKAGING

# LIBERTY TRISIDE

NEW COLOR 2024

## THREE-LENS PANORAMIC MASK



### TECHNICAL FEATURES

- 3-lens panoramic design for excellent peripheral vision.
- Lightweight, durable polycarbonate frame.
- Soft silicone skirt fits a wide range of face shapes.
- Fast-adjust ratcheting strap buckles.
- Easy-access nose pocket for equalization.
- Tempered glass lenses.



### PROFILE VIEW

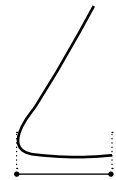

E | 34 mm - 1 5/16 in

The Liberty Triside features a wide mono front lens with 2-sided lenses to ensure a panoramic view without interruption. The result is a mask that allows maximum light and feels as open as the ocean itself. All lenses are tempered glass for the best clarity. The skirt is made in hypoallergenic silicone to ensure comfort and a perfect seal. It is a breeze to adjust the length of the strap thanks to the two buttons on the buckle, which can also be used while wearing gloves. The frame is colored with a paint effect that makes the mask elegant and beautiful to see, which can be coordinated with your equipment.



BLACK/  
GRAPHITE



NEW  
CLEAR/  
YELLOW/BLACK  
Logo Edition



CLEAR  
GOLD



CLEAR/  
SAPPHIRE



CLEAR/  
ROSE GEM



BLACK  
GOLD



BLACK/  
SAPPHIRE



BLACK/  
ROSE GEM

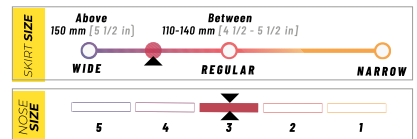

### PRODUCT DIMENSION CHART (SKIRT SIZE)

A - WIDTH	B - HEIGHT	C - NOSE LENGTH	D - NOSE HEIGHT	E - NOSE WIDTH
125 mm	110 mm	32 mm	47 mm	34 mm
4 15/16 in	4 5/16 in	1 4/16 in	1 14/16 in	1 5/16 in

CRESSI'S SIZE CHART IS TO BE USED AS A REFERENCE ONLY

CODE	COLOR	CASE PACK
D5450011	LIBERTY TRISIDE SPE - CLEAR-GOLD	30
D5450027	LIBERTY TRISIDE SPE - CLEAR-SAPPHIRE	30
D5450043	LIBERTY TRISIDE SPE - CLEAR-ROSE GEM	30
D5455010	LIBERTY TRISIDE SPE - BLACK-GOLD	30
D5455020	LIBERTY TRISIDE SPE - BLACK-SAPPHIRE	30
D5455040	LIBERTY TRISIDE SPE - BLACK/ROSE GEM	30
D5455050	LIBERTY TRISIDE SPE - BLACK/GRAPHITE	30
NEW D5450016	LIBERTY TRISIDE - CLEAR/YELLOW/BLACK	30

### SPARE PARTS

CODE	PRODUCT
DZ222000	Strap for Scuba Mask TW - Clear
DZ222050	Strap for Scuba Mask TW - Black
DZ221030	Buckles for Scuba Mask TW - White/Clear
DZ221050	Buckles for Scuba Mask TW - Black/Black
DZ215012	Strap loop for Scuba Mask TW - Black (pair)
DZ215014	Strap loop for Scuba Mask TW - Clear (pair)



PACKAGING

# LIBERTY QUATTRO

## FOUR-LENS PANORAMIC MASK



### TECHNICAL FEATURES

- 4-window mask wide field of view.
- Tempered glass lenses.
- Skirt and strap made of high-grade silicone.
- Spray Painted Effect colored frame that makes the mask elegant and beautiful to see.

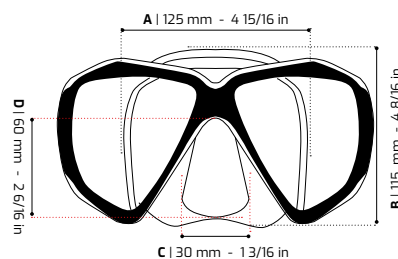

#### PROFILE VIEW

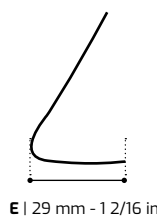

It has the characteristics of guaranteeing a panoramic view thanks to the four window panels. The two side lenses are joined and adjoined with the front lenses to guarantee an uninterrupted view. All lenses are tempered glass for the best clarity. The skirt is made in hypoallergenic silicone to ensure comfort and a perfect seal. It is a breeze to adjust the length of the strap thanks to the two buttons on the buckle, which can also be used while wearing gloves. The frame is colored with a paint effect that makes the mask elegant and beautiful to see, which can be coordinated with your equipment.

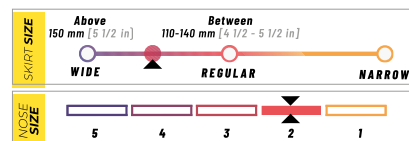

#### PRODUCT DIMENSION CHART (SKIRT SIZE)

A - WIDTH	B - HEIGHT	C - NOSE LENGTH	D - NOSE HEIGHT	E - NOSE WIDTH
125 mm	115 mm	30 mm	60 mm	29 mm
4 15/16 in	4 8/16 in	1 3/16 in	2 6/16 in	1 2/16 in

CRESSI'S SIZE CHART IS TO BE USED AS A REFERENCE ONLY



CLEAR GOLD/SILVER

CLEAR GRAPHITE/SILVER

CLEAR SAPPHIRE/SILVER

BLACK/ GRAPHITE

BLACK/ SAPPHIRE

CODE	COLOR	CASE PACK
DS460015	Clear-Gold/Silver	10
DS460055	Clear-Graphite/Silver	10
DS460025	Clear-Sapphire/Silver	10
DS465050	Black/Graphite	10
DS465020	Black/Sapphire	10

#### SPARE PARTS

CODE	PRODUCT
DZ222000	Strap for Scuba Mask TW - Clear
DZ222050	Strap for Scuba Mask TW - Black
DZ221030	Buckles for Scuba Mask TW - White/Clear
DZ221050	Buckles for Scuba Mask TW - Black/Black
DZ215012	Strap loop for Scuba Mask TW - Black (pair)
DZ215014	Strap loop for Scuba Mask TW - Clear (pair)



PACKAGING



# PENTA+



CLEAR/BLUE



BLACK/BLUE



BLACK/BLACK

The Penta+ is the restyling of the popular Penta mask. It has 4 lenses and also introduces to this sector all the exceptional characteristics of the Matrix and the Lince. The Cressi patented system of raked lenses with an "inverted drop" shape offers incredible downward visibility, ideal for having control of the scuba diving equipment. The clear side windows are made of scratch-resistant material, more strong than glass or polycarbonate. Thanks to them, the mask offers unprecedented lateral visibility and great luminosity for total vision with no compromises. The skirt and the strap are made of hypoallergenic silicone, a very soft material compared to the low-quality PVC, that ensures a perfect seal and comfort. The buckles are embedded in the frame to offer instant adjustment of the strap length, even with one hand. It offers a very low internal volume and a record lightweight.

### TECHNICAL FEATURES

- Four-lens mask
- Tempered glass lenses
- Inverted teardrop lens design to ensure maximum visibility
- Strap buckles: pressure, with instant adjustment
- Very low internal volume
- Silicone skirt and double strap
- Weight: 175 g - 6.2 oz

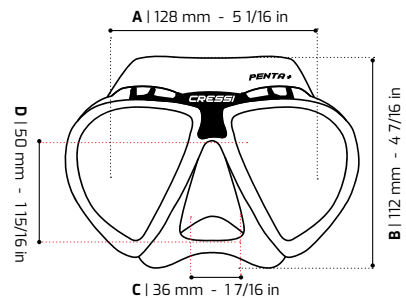

PROFILE VIEW



E | 30 mm - 1 3/16 in

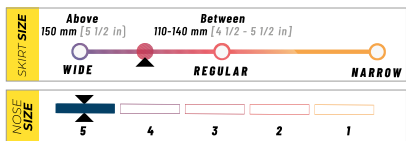

**PRODUCT DIMENSION CHART (SKIRT SIZE)**

A - WIDTH	B - HEIGHT	C - NOSE LENGTH	D - NOSE HEIGHT	E - NOSE WIDTH
128 mm 5 1/16 in	112 mm 4 7/16 in	36 mm 1 7/16 in	50 mm 1 15/16 in	30 mm 1 3/16 in

CRESSI'S SIZE CHART IS TO BE USED AS A REFERENCE ONLY

CODE	COLOR	CASE PACK
DS490020	Clear/Blue	6
DS495020	Black/Blue	6
DS495050	Black/Black	6



# MATRIX



The compact twin-lens Matrix takes the basic design concepts of the Big Eyes Evolution and pushes them to a new level of performance. More pronounced inverted tear-drop shaped lenses, raked inward to sit even closer to the eyes, and a more compact build overall make the Matrix an ideal choice for divers and freedivers looking for the biggest view in the smallest package.



YELLOW



BLUE



CLEAR/BLACK



BLACK/BLACK



DARK GREEN

CODE	COLOR	CASE PACK
D5301010	YELLOW	6
D5301020	BLUE	6
D5301060	CLEAR/BLACK	6
D5302050	BLACK/BLACK	6
D5309850	DARK GREEN	6

SPARE PARTS

CODE	PRODUCT
D2215003	SILICONE STRAP - CLEAR for ITALIAN SCUBA MASK
D2215004	SILICONE STRAP - BLACK for ITALIAN SCUBA MASK
D2210018	BUCKLES - BLACK for MATRIX/LINCE/PENTA
D2215009	STRAP LOOP SMALL for PRO DIVE MASKS - CLEAR (PAIR)
D2215011	STRAP LOOP SMALL for PRO DIVE MASKS - BLACK (PAIR)
D2400001	SIDE FRAME CLIPS for MATRIX MASK (PAIR) - CLEAR

## TECHNICAL FEATURES

- Raked lenses provide excellent field-of-view
- Extremely low internal volume on par with the best free diving masks
- Silicone skirt shaped to provide a wide sealing surface for a leak-free fit
- Micrometric adjustable buckles allow precise headband adjustments
- Overmolded frame is easy to grip
- Inverted tear-drop lenses improve downward visibility for managing BC-mounted gear

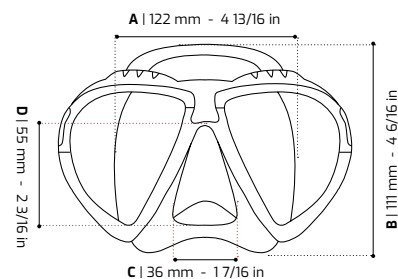

PROFILE VIEW

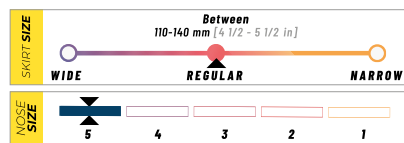
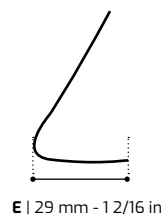

### PRODUCT DIMENSION CHART (SKIRT SIZE)

A - WIDTH	B - HEIGHT	C - NOSE LENGTH	D - NOSE HEIGHT	E - NOSE WIDTH
122 mm	111 mm	36 mm	55 mm	29 mm
4 13/16 in	4 6/16 in	1 7/16 in	2 3/16 in	1 2/16 in

CRESSI'S SIZE CHART IS TO BE USED AS A REFERENCE ONLY



PACKAGING

## CRESSI PATENTED TECHNOLOGIES

★ **INCLINED GLASSES**  
US 6272693 B1



Cressi has developed and patented in 2001 a particular mask frame that to solve the problem of the divers not being able to easily see the scuba equipment. A scuba diver carrying many different pieces of equipment, some of them are vital like the pressure and depth gauges. The solution has been found designing a new frame shape that is inclined downwards. Moreover, the shape of the lens is designed like an inverted teardrop increasing drastically the downward visibility.

★ **INTEGRATED BUCKLES**  
US 8281417 B2

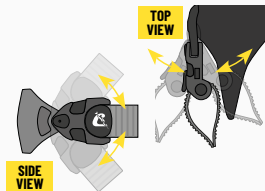

The patented technology is to provide a mask for aquatic activities that avoid loss of watertight during strap-tightening by a diver when the mask is in use underwater. The object of the invention is to avoid exertion of a tensile force or stress during mask adjustment and, in turn, rupture of the skirt. The buckles are not directly fixed to the frame but anchored to the rubber of the skirt, allowing it to freely swivel and pivot in all directions. The buckles are joined with lateral sides of the frame by brackets extending from the lateral sides. The brackets are made of a selected flexible material. This feature facilitates the mask storage when not in use.

★ **INTEGRATED DUAL FRAME**  
US 20140013494 A1

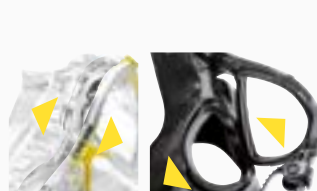

The Patented Integrated Dual Frame Technology consists of the joining of two rigid frames: the first on the rear of the silicone skirt and the second, anterior to the first one, that support the lenses. When the two frames are joined and locked together, the silicone skirt remains locked in the middle to guarantee a perfect seal between the face piece and the lens. This technology produces a drastic reduction in the internal volume, while keeping the lenses close to the eyes to ensure a wide view laterally and in the lower zone. The result is a mask with an extremely hydrodynamic shape and low volume.

# LINCE



A trimmed down version of the Matrix, the Lince is a perfect fit for many younger divers or those with narrower faces. The extremely low internal volume makes it comfortable to wear and effortless to clear. Divers and snorkelers alike will appreciate the exceptional field of view offered in this ultra compact mask.



CODE	COLOR	CASE PACK
D5311010	YELLOW	6
D5311030	LILAC	6
D5311040	PINK	6
D5311063	AQUAMARINE	6
D5312050	BLACK/BLACK	6

SPARE PARTS

CODE	PRODUCT
D2215003	SILICONE STRAP - CLEAR for ITALIAN SCUBA MASK
D2215004	SILICONE STRAP - BLACK for ITALIAN SCUBA MASK
D2210018	BUCKLES - BLACK for MATRIX/LINCE/PENTA
D2215009	STRAP LOOP SMALL for PRO DIVE MASKS - CLEAR (PAIR)
D2215011	STRAP LOOP SMALL for PRO DIVE MASKS - BLACK (PAIR)

CRESSI PATENTED TECHNOLOGIES

★ INCLINED GLASSES  
US 6272693 B1

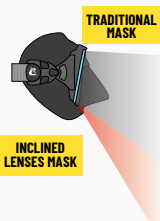

Cressi has developed and patented in 2001 a particular mask frame that to solve the problem of the divers not being able to easily see the scuba equipment. A scuba diver carrying many different pieces of equipment, some of them are vital like the pressure and depth gauges. The solution has been found designing a new frame shape that is inclined downwards. Moreover, the shape of the lens is designed like an inverted teardrop increasing drastically the downward visibility.

★ INTEGRATED BUCKLES  
US 8281417 B2

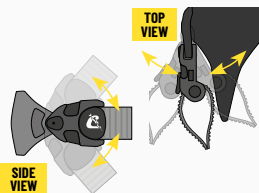

The patented technology is to provide a mask for aquatic activities that avoid loss of watertight during strap-tightening by a diver when the mask is in use underwater. The object of the invention is to avoid exertion of a tensile force or stress during mask adjustment and, in turn, rupture of the skirt. The buckles are not directly fixed to the frame but anchored to the rubber of the skirt, allowing it to freely swivel and pivot in all directions. The buckles are joined with lateral sides of the frame by brackets extending from the lateral sides. The brackets are made of a selected flexible material. This feature facilitates the mask storage when not in use.

★ INTEGRATED DUAL FRAME  
US 20140013494 A1

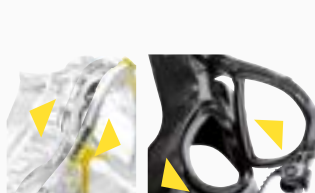

The Patented Integrated Dual Frame Technology consists of the joining of two rigid frames, the first on the rear of the silicone skirt and the second, anterior to the first one, that support the lenses. When the two frames are joined and locked together, the silicone skirt remains locked in the middle to guarantee a perfect seal between the face piece and the lens. This technology produces a drastic reduction in the internal volume, while keeping the lenses close to the eyes to ensure a wide view laterally and in the lower zone. The result is a mask with an extremely hydrodynamic shape and low volume.

TECHNICAL FEATURES

- Drastically reduced internal volume
- Instant-adjust pressure-strap buckles
- Skirt designed for women and children
- Excellent visibility and comfort
- For all underwater activities

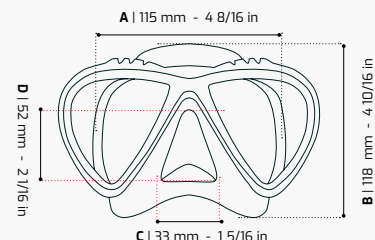

SKIRT SIZE



NOSE SIZE



CRESSI'S SIZE CHART IS TO BE USED AS A REFERENCE ONLY



PACKAGING



# BIG EYES



The mask that began a revolution remains one of the most duplicated designs today. Its inverted tear-drop lens shape and raked lenses provide 30% greater field of view than typical twin-lens masks. The high-grade silicone skirt's unique shape positions the lenses comfortably close to the eyes and provides an excellent seal.

## TECHNICAL FEATURES

- Raked lenses provide excellent field of view
- Inverted tear drop lenses improve downward visibility for managing BC-mounted gear
- Low internal volume allows for effortless clearing
- High-grade silicone skirt provides a leak-free seal
- Micrometrically adjusting buckles

## OPTICAL LENSES POSSIBILITY OF MOUNTING OPTICAL LENSES

- CORRECTION -1.0 > -6.00



### NOT SYMMETRICAL LENSES

- The lenses are available positive for correcting nearsightedness (**myopia**).

OPTICAL LENSES INSTALLATION **\$5.00**

COMPLETE INFORMATION OPTICAL LENSES  
PLEASE REFER TO PAGE 144 CHART



CODE	COLOR	CASE PACK
D5261010	BIG EYES - CLEAR/YELLOW	6
D5261020	BIG EYES - CLEAR/BLUE	6
D5261060	BIG EYES - CLEAR/CLEAR	6
D5261062	BIG EYES - CLEAR/COBALT	6
D5262020	BIG EYES - BLACK/BLUE	6
D5262050	BIG EYES - BLACK/BLACK	6

## SPARE PARTS

CODE	PRODUCT
D2215005	SILICONE STRAP - CLEAR for BIG EYES
D2215006	SILICONE STRAP - BLACK for BIG EYES
D2215007	STRAP LOOP LARGE for BIG EYES - CLEAR (PAIR)
D2215013	STRAP LOOP LARGE for BIG EYES - BLACK (PAIR)

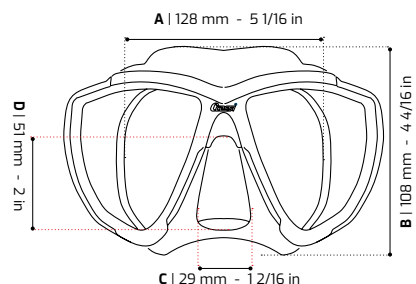

### PROFILE VIEW

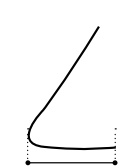

### PRODUCT DIMENSION CHART (SKIRT SIZE)

A - WIDTH	B - HEIGHT	C - NOSE LENGTH	D - NOSE HEIGHT	E - NOSE WIDTH
128 mm 5 1/16 in	108 mm 4 4/16 in	29 mm 1 2/16 in	51 mm 2 in	27 mm 1 1/16 in

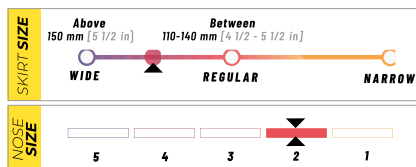

Cressi's Size Chart is to be used as a reference only  
++ Measure ear to ear with a ruler

CODE	PRODUCT
D1260010	OPTICAL LENS -1.0 (RIGHT) for BIG EYES
D1260015	OPTICAL LENS -1.5 (RIGHT) for BIG EYES
D1260020	OPTICAL LENS -2.0 (RIGHT) for BIG EYES
D1260025	OPTICAL LENS -2.5 (RIGHT) for BIG EYES
D1260030	OPTICAL LENS -3.0 (RIGHT) for BIG EYES
D1260035	OPTICAL LENS -3.5 (RIGHT) for BIG EYES
D1260040	OPTICAL LENS -4.0 (RIGHT) for BIG EYES
D1260045	OPTICAL LENS -4.5 (RIGHT) for BIG EYES
D1260050	OPTICAL LENS -5.0 (RIGHT) for BIG EYES
D1260055	OPTICAL LENS -5.5 (RIGHT) for BIG EYES
D1260060	OPTICAL LENS -6.0 (RIGHT) for BIG EYES
D1260110	OPTICAL LENS -1.0 (LEFT) for BIG EYES
D1260115	OPTICAL LENS -1.5 (LEFT) for BIG EYES
D1260120	OPTICAL LENS -2.0 (LEFT) for BIG EYES
D1260125	OPTICAL LENS -2.5 (LEFT) for BIG EYES
D1260130	OPTICAL LENS -3.0 (LEFT) for BIG EYES
D1260135	OPTICAL LENS -3.5 (LEFT) for BIG EYES
D1260140	OPTICAL LENS -4.0 (LEFT) for BIG EYES
D1260145	OPTICAL LENS -4.5 (LEFT) for BIG EYES
D1260150	OPTICAL LENS -5.0 (LEFT) for BIG EYES
D1260155	OPTICAL LENS -5.5 (LEFT) for BIG EYES
D1260160	OPTICAL LENS -6.0 (LEFT) for BIG EYES



PACKAGING

# FOCUS



The ultimate in versatility, this classic mask offers the best fit and performance for the greatest variety of facial shapes. Its low-volume, twin-lens design gives divers and snorkelers a proven combination of size, fit and durability. Lightweight and easy-to-clear it has swiveling, quick-adjust buckles and accepts corrective lenses. It is also an excellent value.



CODE	COLOR	CASE PACK
D5241010	Clear/Yellow	6
D5241020	Clear/Blue	6
D5241040	Clear/Pink	6
D5241060	Clear/Black	6
D5241063	Clear/Aquamarine	6
D5242020	Black/Blue	6
D5242050	Black/Black	6
WD5241041	Clear/White-Lilac	6

SPARE PARTS

CODE	PRODUCT
DZ210010	BUCKLES - BLACK for FOCUS/SKY
DZ215003	SILICONE STRAP - CLEAR for ITALIAN SCUBA MASK
DZ215004	SILICONE STRAP - BLACK for ITALIAN SCUBA MASK
DZ215009	STRAP LOOP SMALL for PRO DIVE MASKS - CLEAR (PAIR)
DZ215011	STRAP LOOP SMALL for PRO DIVE MASKS - BLACK (PAIR)

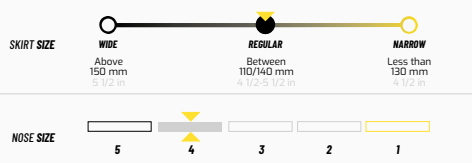
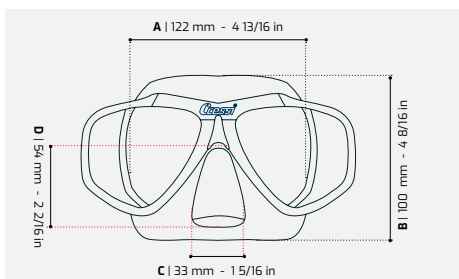

CRESSI'S SIZE CHART TO BE USED AS A REFERENCE ONLY

## TECHNICAL FEATURES

- Low internal volume allows for effortless clearing
- Lightweight, compact and rugged
- Ideal for travel or as a backup mask
- High-grade silicone skirt provides a leak-free seal
- Fixed quick-adjusting buckles

## OPTICAL LENSES POSSIBILITY OF MOUNTING OPTICAL LENSES

- CORRECTION -1.0 > -6.0D



LEFT AND RIGHT FROM D1240010 TO D1240080

- BIFOCAL LENS - CORRECTION +1.0 > +4.0



LEFT FROM D1240110 TO D1240140



RIGHT FROM D1240210 TO D1240240

### SYmmETRICAL LENSES

- The lenses are available positive for correcting nearsightedness (**myopia**).
- The lenses are available with bifocal optics for corrective farsightedness (**hyperopia**).

OPTICAL LENSES INSTALLATION \$5.00

COMPLETE INFORMATION OPTICAL LENSES PLEASE REFER TO PAGE 144 CHART



PACKAGING



# PACIFICO



**RUBBER MASK**

CODE	CASE PACK
ZDN320050	10

## TECHNICAL FEATURES

- Single lens in a classic retro oval shape
- Scratch resistant tempered glass for clarity and safety
- Rubber skirt and strap for great seal and comfort
- Easily adjustable buckles

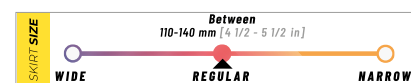
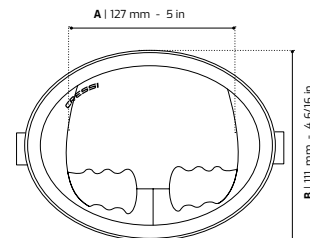

PRODUCT DIMENSION CHART (SKIRT SIZE)			
A - WIDTH	B - HEIGHT	A - WIDTH	B - HEIGHT
127 mm	111 mm	5 in	4 6/16 in

2024 - CATALOG

# TROPICAL



CODE	COLOR	CASE PACK
US401001	Black/Black	10

SPARE PARTS

CODE	PRODUCT
UZ401001	MASK STRAP + RETAINERS - BLACK (TROPICAL)
UZ401002	MASK STRAP + RETAINERS - CLEAR (TROPICAL)

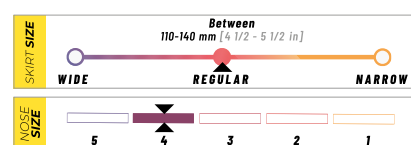
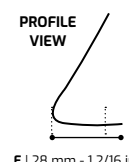
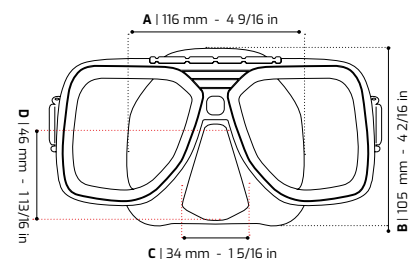

PRODUCT DIMENSION CHART (SKIRT SIZE)				
A - WIDTH	B - HEIGHT	C - NOSE LENGTH	D - NOSE HEIGHT	E - NOSE WIDTH
116 mm	105 mm	34 mm	46 mm	28 mm
4 9/16 in	4 2/16 in	1 5/16 in	1 13/16 in	1 2/16 in

CRESSI



# MASK SIZE CHART

## MASK FIT SIZE



++ Measure your face from ear to ear with a ruler to find your proper fit.

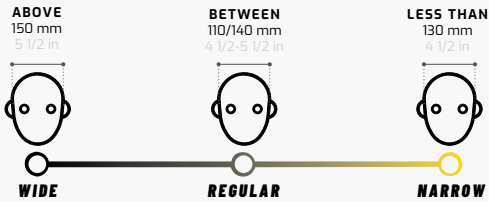

MASK	SKIRT (OUTER)				SIZING GUIDE	GENDER
	WIDTH (mm)	HEIGHT (mm)	WIDTH (in)	HEIGHT (in)		
ROMBO	134	98	5 2/8	3 7/8	WIDE / REGULAR	ADULT
A1	130	118	5 1/8	4 5/8	WIDE / REGULAR	ADULT
SF1	129	107	5 1/8	4 2/8	WIDE / REGULAR	ADULT
F-DUAL	130	104	5 1/8	4 1/8	WIDE / REGULAR	ADULT
ATOM	129	101	5 1/8	4	WIDE / REGULAR	ADULT
FI	127	114	5	4 1/2	WIDE / REGULAR	ADULT
PENTA+	128	112	5	4 3/8	WIDE / REGULAR	ADULT
PACIFICO	127	111	5	4 3/8	WIDE / REGULAR	ADULT
PANO 3	126	110	5	4 3/8	WIDE / REGULAR	ADULT
BIG EYES	128	108	5	4 2/8	WIDE / REGULAR	ADULT
LIBERTY	125	135	4 7/8	5 3/8	WIDE / REGULAR	ADULT
TINO	124	115	4 7/8	4 1/2	WIDE / REGULAR	ADULT
LIBERTY QUATTRO	125	115	4 7/8	4 1/2	WIDE / REGULAR	ADULT
LIBERTY TRISIDE	125	110	4 7/8	4 3/8	WIDE / REGULAR	ADULT
BIG EYES EVOLUTION	124	110	4 7/8	4 3/8	WIDE / REGULAR	ADULT
LIBERTY DUO	125	108	4 7/8	4 2/8	WIDE / REGULAR	ADULT
ESTRELLA	125	106	4 7/8	4 1/8	REGULAR	ADULT
ONDA	125	103	4 7/8	4	REGULAR	ADULT
MUSA	124	102	4 7/8	4	REGULAR	ADULT
FOCUS	122	115	4 6/8	4 1/2	REGULAR	ADULT
QUANTUM	120	115	4 6/8	4 1/2	REGULAR	ADULT
SIRENA	120	114	4 6/8	4 1/2	REGULAR	ADULT
MATRIX	122	111	4 6/8	4 3/8	REGULAR	ADULT
IKARUS	120	110	4 6/8	4 3/8	REGULAR	ADULT
MAREA	120	106	4 6/8	4 1/8	REGULAR	ADULT
METIS	120	105	4 6/8	4 1/8	REGULAR	ADULT
PERLA	122	105	4 6/8	4 1/8	REGULAR	ADULT
NAXOS	120	105	4 6/8	4 1/8	REGULAR	ADULT
LINCE	115	118	4 1/2	4 5/8	REGULAR	ADULT
AIR	115	110	4 1/2	4 3/8	REGULAR	ADULT
EYES EVOLUTION	114	106	4 1/2	4 1/8	REGULAR	ADULT
ZEUS	116	108	4 5/8	4 2/8	REGULAR	ADULT
FI SMALL	119	108	4 5/8	4 2/8	REGULAR/NARROW	ADULT
TROPICAL	116	105	4 5/8	4 1/8	REGULAR/NARROW	ADULT
NANO	118	104	4 5/8	4 1/8	REGULAR/NARROW	ADULT
CALIBRO	112	103	4 3/8	4	REGULAR/NARROW	ADULT
CALIBRO+	112	103	4 3/8	4	REGULAR/NARROW	ADULT
MOON	127	73	5	2 7/8	REGULAR/KIDS	KID
PEGASO	113	113	4 1/2	4 1/2	REGULAR/KIDS	KID
ESTRELLA JR	112	106	4 3/8	4 1/8	REGULAR/KIDS	KID
ONDINA	112	100	4 3/8	3 7/8	REGULAR/KIDS	KID
TINETTO	112	86	4 3/8	3 3/8	REGULAR/KIDS	KID
MAREA JR	111	99	4 3/8	3 7/8	REGULAR/KIDS	KID
PERLA JR	111	99	4 3/8	3 7/8	REGULAR/KIDS	KID
PIUMETTA	100	100	3 7/8	3 7/8	REGULAR/KIDS	KID



LARGER

SMALLER



## COATED LENSES FEATURES DETAILS

### BLUE/ORANGE LENSES

D5505952 F-DUAL - BLACK/BLACK 80% UV BLUE/ORANGE

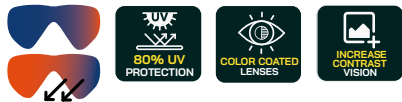

### YELLOW/BLUE LENSES

D5505951 F-DUAL - BLACK/BLACK 80% UV AG YELLOW/BLUE LENSES  
D5445250 LIBERTY DUO - BLACK/BLACK 80% UV AG YELLOW/BLUE LENSES  
U5411050 METIS - BLACK/BLACK 80% UV AG YELLOW/BLUE LENSES

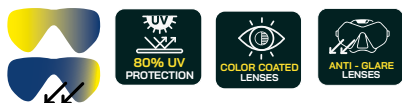

### PINK/BLUE LENSES

U5411010 METIS - BLACK/BLACK PINK/BLUE LENSES



### 420 UV BLUE/RED LENSES

HIGH ENERGY VISIBLE LIGHT PROTECTION

D54750509 ZEUS MASK BLACK/BLACK 420 UV BLUE/RED LENSES  
D55150509 QUANTUM MASK BLACK/BLACK 420 UV BLUE/RED



### SPECTRA MIRRORED LENSES

60% UV - SEMI-REFLECTIVE

D5366050 NANO MASK BLACK/BLACK SPECTRA MIRRORED LENS SILVER  
D5426050 CALIBRO MASK BLACK/BLACK SPECTRA MIRRORED LENS SILVER  
D55150508 QUANTUM MASK BLACK/BLACK SPECTRA MIRRORED LENS SILVER  
DN305150 ROMBO - BLACK/BLACK-80% UV AG YELLOW/BLUE LENSES



### 420 UV YELLOW/BLUE LENSES

HIGH ENERGY VISIBLE LIGHT PROTECTION



### ANTI-FOG FILM



XDN400013 A1-BLACK/BLUE-CLEAR ANTI-FOG LENS  
XDN400021 A1-BLACK/PINK-CLEAR ANTI-FOG LENS  
XDN400057 A1-BLACK/GRAPHITE-CLEAR ANTI-FOG LENS  
XDN400061 A1-WHITE/WHITE-CLEAR ANTI-FOG LENS  
D5390059 LIBERTY-CLEAR/BLACK-CLEAR ANTI-FOG LENS  
D5395550 LIBERTY-BLACK/BLACK-CLEAR ANTI-FOG LENS  
D5445155 LIBERTY DUO-BLACK/TITANIUM-CLEAR ANTI-FOG LENS  
U5415550 METIS-BLACK/BLACK-CLEAR ANTI-FOG LENS  
YDM423072 METIS-WHITE/TITANIUM-CLEAR ANTI-FOG LENS

UV420 BLOCK	UV PROTECTION	INCREASED CONTRAST	ANTI-REFLECTION (AR)	ANTI-GLARE
UV420-coated glass can protect the eye-retina from harmful High Energy Visible light (HEV). HEVs occur on sunny days and in clouds; therefore, protecting eyes from UV and HEV under all weather when diving is essential. Optical coating UV420 glass gives you good eye protection and excellent sight definition during diving.	It protects the eyes from UV RAYS and heavy sunlight and reinforces the color contrast of eyesight in the water.	The coating enhances the lens's contrast, allowing divers to see object contours and details more clearly, improving diving safety and enjoyment.	Anti-reflection coated glass can reduce the reflection of light from the inner and outer to pull the light transmission rate up to 92% to reinforce the color, definition, and contrast and provide better vision under the water.	Specifically designed to combat the glare from sun bright lights, which can help reduce eye strain. Improve visual clarity in bright conditions and diminish the harshness of the light that enters the eyes.

CRESSI

### MASK STRAP LOOP

Clear - Big Eyes - Focus - Superocchio



CODE  
DZ215007

### MASK STRAP LOOP

Black - Big Eyes - Focus - Superocchio



CODE  
DZ215013

### MASK STRAP LOOP

Clear - Big Eyes Evolution - Eyes Evolution - Lince - Matrix - Nano - Penta



CODE  
DZ215009

### MASK STRAP LOOP

Black - Big Eyes Evolution - Eyes Evolution - Lince - Matrix - Nano - Penta



CODE  
DZ215011

### MASK STRAP

Clear - Big Eyes - Focus



CODE  
DZ215005

### MASK STRAP

Black - Big Eyes - Focus - Pinocchio - Superocchio



CODE  
DZ215006

### PROFESSIONAL STRAP

Clear - Air - Big Eyes Evo - Calibro - Eyes Evo - Matrix - Lince - Penta+



CODE  
DZ215003

### PROFESSIONAL STRAP

Black - Air - Big Eyes Evo - Calibro - Eyes Evo - Matrix - Lince - Penta+



CODE  
DZ215004

### STRAP CRYSTAL MASK

Silver - Air - Big Eyes Evo - Eyes Evo - Nano (Crystal version)



CODE  
DZ215002

### TW MASK STRAP

A1 - F-Dual - F1 - Liberty - Metis - SF1 - Z1 - Z51

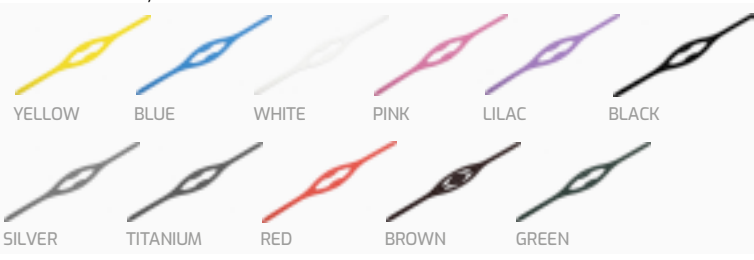

CODE	COLOR
DZ222000	Clear
DZ222010	Yellow
DZ222020	Blue
DZ222030	White
DZ222040	Pink
DZ222041	Lilac
DZ222050	Black
DZ222051	Silver
DZ222072	Titanium
DZ222080	Red
DZ222088	Brown
DZ222090	Green

### MASK STRAP

Black - Minima



CODE  
DZ210019

**BUCKLES**

Big Eyes



CODE  
DZ210008

**BUCKLES**

Focus



CODE  
DZ210010

**BUCKLES**

Lince · Matrix · Penta+

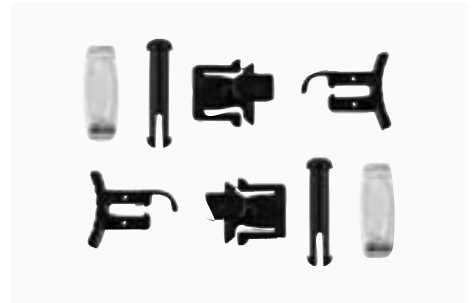

CODE  
DZ210018

**BUCKLES**

Air · Big Eyes Evo · Calibro · Eyes Evo · Nano

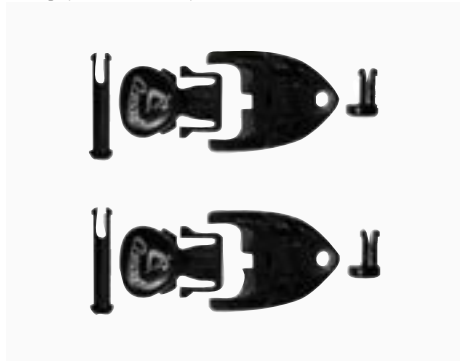

CODE  
DZ210021

**BUCKLES**

Onda · Ondina · Perla · Piumetta · Sirena



CODE  
DZ210005

**BUCKLES**

Estrella · Marea · Marea Jr



CODE  
DZ210020

**BUCKLES FOR SUPEROCCIO**



CODE  
DZ210004

**BUCKLES FOR TW MASK**

A1 · F-Dual · F1 · Liberty · Metis · SF1 · Z1 · Z51



CODE	COLOR
DZ221000	Black/Clear
DZ221030	White/Clear
DZ221040	Pink/Clear
DZ221050	Black/Black



## OPTICAL LENSES

### FOCUS

The Optical Lens are sold individually. The Focus lenses can be mounted both for left and right.

PLEASE ALSO REFER TO THE CRESSI SPARE PARTS CATALOG FOR FURTHER INFORMATION AND TECHNICAL DETAILS

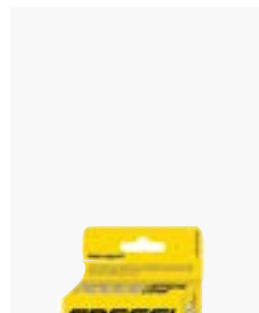

### BIG EYES EVOLUTION & QUANTUM

PLEASE ALSO REFER TO THE CRESSI SPARE PARTS CATALOG FOR FURTHER INFORMATION AND TECHNICAL DETAILS

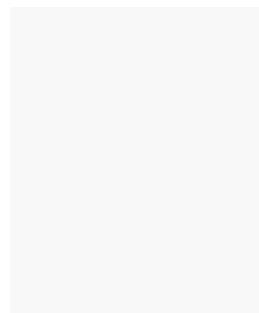

### BIG EYES

PLEASE ALSO REFER TO THE CRESSI SPARE PARTS CATALOG FOR FURTHER INFORMATION AND TECHNICAL DETAILS

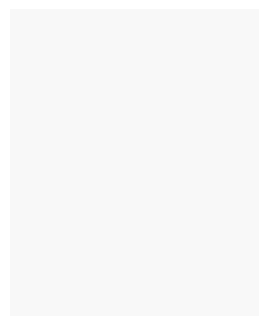

CODE	PRODUCT
DI240110	BIFOCAL OPTICAL LENS +1.0 (LEFT) for FOCUS
DI240115	BIFOCAL OPTICAL LENS +1.5 (LEFT) for FOCUS
DI240120	BIFOCAL OPTICAL LENS +2.0 (LEFT) for FOCUS
DI240125	BIFOCAL OPTICAL LENS +2.5 (LEFT) for FOCUS
DI240130	BIFOCAL OPTICAL LENS +3.0 (LEFT) for FOCUS
DI240135	BIFOCAL OPTICAL LENS +3.5 (LEFT) for FOCUS
DI240210	BIFOCAL OPTICAL LENS +1.0 (RIGHT) for FOCUS
DI240215	BIFOCAL OPTICAL LENS +1.5 (RIGHT) for FOCUS
DI240220	BIFOCAL OPTICAL LENS +2.0 (RIGHT) for FOCUS
DI240225	BIFOCAL OPTICAL LENS +2.5 (RIGHT) for FOCUS
DI240230	BIFOCAL OPTICAL LENS +3.0 (RIGHT) for FOCUS
DI240235	BIFOCAL OPTICAL LENS +3.5 (RIGHT) for FOCUS
DI240240	BIFOCAL OPTICAL LENS +4.0 (RIGHT) for FOCUS
DI240015	OPTICAL LENS -1.5 for FOCUS
DI240020	OPTICAL LENS -2.0 for FOCUS
DI240025	OPTICAL LENS -2.5 for FOCUS
DI240030	OPTICAL LENS -3.0 for FOCUS
DI240035	OPTICAL LENS -3.5 for FOCUS
DI240040	OPTICAL LENS -4.0 for FOCUS
DI240045	OPTICAL LENS -4.5 for FOCUS
DI240050	OPTICAL LENS -5.0 for FOCUS
DI240055	OPTICAL LENS -5.5 for FOCUS
DI240060	OPTICAL LENS -6.0 for FOCUS
DI240065	OPTICAL LENS -6.5 for FOCUS
DI240070	OPTICAL LENS -7.0 for FOCUS
DI240075	OPTICAL LENS -7.5 for FOCUS
DI240080	OPTICAL LENS -8.0 for FOCUS

CODE	PRODUCT
DI335010	BIFOCAL OPTICAL LENS +1.0 (RIGHT) for BIG EYES EVO/QUANTUM
DI335015	BIFOCAL OPTICAL LENS +1.5 (RIGHT) for BIG EYES EVO/QUANTUM
DI335020	BIFOCAL OPTICAL LENS +2.0 (RIGHT) for BIG EYES EVO/QUANTUM
DI335025	BIFOCAL OPTICAL LENS +2.5 (RIGHT) for BIG EYES EVO/QUANTUM
DI335030	BIFOCAL OPTICAL LENS +3.0 (RIGHT) for BIG EYES EVO/QUANTUM
DI336010	OPTICAL LENS - 1.0 (RIGHT) for BIG EYES EVO/QUANTUM
DI336015	OPTICAL LENS - 1.5 (RIGHT) for BIG EYES EVO/QUANTUM
DI336020	OPTICAL LENS - 2.0 (RIGHT) for BIG EYES EVO/QUANTUM
DI336025	OPTICAL LENS - 2.5 (RIGHT) for BIG EYES EVO/QUANTUM
DI336030	OPTICAL LENS - 3.0 (RIGHT) for BIG EYES EVO/QUANTUM
DI336035	OPTICAL LENS - 3.5 (RIGHT) for BIG EYES EVO/QUANTUM
DI336040	OPTICAL LENS - 4.0 (RIGHT) for BIG EYES EVO/QUANTUM
DI336045	OPTICAL LENS - 4.5 (RIGHT) for BIG EYES EVO/QUANTUM
DI336050	OPTICAL LENS - 5.0 (RIGHT) for BIG EYES EVO/QUANTUM
DI336055	OPTICAL LENS - 5.5 (RIGHT) for BIG EYES EVO/QUANTUM
DI336060	OPTICAL LENS - 6.0 (RIGHT) for BIG EYES EVO/QUANTUM
DI335110	BIFOCAL OPTICAL LENS +1.0 (LEFT) for BIG EYES EVO/QUANTUM
DI335115	BIFOCAL OPTICAL LENS +1.5 (LEFT) for BIG EYES EVO/QUANTUM
DI335120	BIFOCAL OPTICAL LENS +2.0 (LEFT) for BIG EYES EVO/QUANTUM
DI335125	BIFOCAL OPTICAL LENS +2.5 (LEFT) for BIG EYES EVO/QUANTUM
DI335130	BIFOCAL OPTICAL LENS +3.0 (LEFT) for BIG EYES EVO/QUANTUM
DI336110	OPTICAL LENS - 1.0 (LEFT) for BIG EYES EVO/QUANTUM
DI336115	OPTICAL LENS - 1.5 (LEFT) for BIG EYES EVO/QUANTUM
DI336120	OPTICAL LENS - 2.0 (LEFT) for BIG EYES EVO/QUANTUM
DI336125	OPTICAL LENS - 2.5 (LEFT) for BIG EYES EVO/QUANTUM
DI336130	OPTICAL LENS - 3.0 (LEFT) for BIG EYES EVO/QUANTUM
DI336135	OPTICAL LENS - 3.5 (LEFT) for BIG EYES EVO/QUANTUM
DI336140	OPTICAL LENS - 4.0 (LEFT) for BIG EYES EVO/QUANTUM
DI336145	OPTICAL LENS - 4.5 (LEFT) for BIG EYES EVO/QUANTUM
DI336150	OPTICAL LENS - 5.0 (LEFT) for BIG EYES EVO/QUANTUM
DI336155	OPTICAL LENS - 5.5 (LEFT) for BIG EYES EVO/QUANTUM
DI336160	OPTICAL LENS - 6.0 (LEFT) for BIG EYES EVO/QUANTUM

CODE	PRODUCT
DI260010	OPTICAL LENS -1.0 (RIGHT) for BIG EYES
DI260015	OPTICAL LENS -1.5 (RIGHT) for BIG EYES
DI260020	OPTICAL LENS -2.0 (RIGHT) for BIG EYES
DI260025	OPTICAL LENS -2.5 (RIGHT) for BIG EYES
DI260030	OPTICAL LENS -3.0 (RIGHT) for BIG EYES
DI260035	OPTICAL LENS -3.5 (RIGHT) for BIG EYES
DI260040	OPTICAL LENS -4.0 (RIGHT) for BIG EYES
DI260045	OPTICAL LENS -4.5 (RIGHT) for BIG EYES
DI260050	OPTICAL LENS -5.0 (RIGHT) for BIG EYES
DI260055	OPTICAL LENS -5.5 (RIGHT) for BIG EYES
DI260060	OPTICAL LENS -6.0 (RIGHT) for BIG EYES
DI260110	OPTICAL LENS -1.0 (LEFT) for BIG EYES
DI260115	OPTICAL LENS -1.5 (LEFT) for BIG EYES
DI260120	OPTICAL LENS -2.0 (LEFT) for BIG EYES
DI260125	OPTICAL LENS -2.5 (LEFT) for BIG EYES
DI260130	OPTICAL LENS -3.0 (LEFT) for BIG EYES
DI260135	OPTICAL LENS -3.5 (LEFT) for BIG EYES
DI260140	OPTICAL LENS -4.0 (LEFT) for BIG EYES
DI260145	OPTICAL LENS -4.5 (LEFT) for BIG EYES
DI260150	OPTICAL LENS -5.0 (LEFT) for BIG EYES
DI260155	OPTICAL LENS -5.5 (LEFT) for BIG EYES
DI260160	OPTICAL LENS -6.0 (LEFT) for BIG EYES

### ANTI-FOG SPRAY

60 ml



Effective anti-fog for masks and goggles.

Spread on the inside of the lenses, before wetting them.

CODE

DF200050

### ANTIFOG GEL

30 ml



Effective anti-fog for masks and goggles.

Spread on the inside of the lenses, before wetting them.

CODE

DF200052

### MINIFOG SPONGE

15 ml



It incorporates a sponge that allows a very precise dosage and, therefore, a great saving of product. The sponge contributes to the elimination of the grease film of the glass produced by the vapors of the silicone after its vulcanization.

CODE

DF200053

### MASK STRAP COVER

SOFT NEOPRENE



CODE COLOR

D5339992	Blue
D5339994	Pink
D5339995	Black
D5339996	Yellow
D5339997	Red

### SIMPLY MASK STRAP COVER

SOFT NEOPRENE



BLUE/WHITE



PINK/WHITE



BLACK/YELLOW

CODE COLOR

DQ011050	Yellow/Black
DQ012030	Blue/White
DQ015010	Black/Yellow

### PONY TAIL MASK STRAP COVER

SOFT NEOPRENE



YELLOW/BLACK



BLUE/WHITE



PINK/WHITE

CODE COLOR

DQ021050	Yellow/Black
DQ022030	Blue/White
DQ024030	Pink/White
DQ025010	Black/Yellow





**SNORKELS**  
SCUBA





# ITACA ULTRA DRY

## DRY TOP | PURGE VALVE

It has a patented dry guard at the top end that prevents water entry while using it on the surface. It has three movement joints that ensure immediate opening of the upper valve. The lower part has a smooth, flexible corrugated section that keeps the aerator away from the mouth while using any breathing apparatus. The mouthpiece is made of soft silicone and has an ergonomic angle with reduced bite-size to avoid gum fatigue. There is a lower purge valve for instant clearing, and the transparent tube has side reinforcement in colored rubber.



CLEAR/BLUE CLEAR/PINK CLEAR/BLACK CLEAR/RED

BLACK/GOLD BLACK/BLUE BLACK/BLACK BLACK/RED



### TECHNICAL FEATURES

- Special patented Aquastop valve: very efficient on up/down positions
- Dry guard: seals breathing tube when submerged
- Mouthpiece: drops away when not in use-great for scuba divers
- High-quality silicone mouthpiece: is comfortable and durable
- Angled anatomical mouthpiece: reduces jaw fatigue
- Lower purge valve: allows water to be quickly expelled
- Streamlined design reduces drag while swimming
- Adjustable keeper for securing to any mask

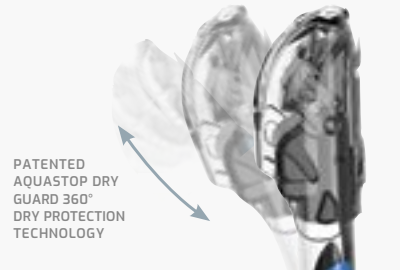

PATENTED AQUASTOP DRY GUARD 360° DRY PROTECTION TECHNOLOGY

### PACKAGING

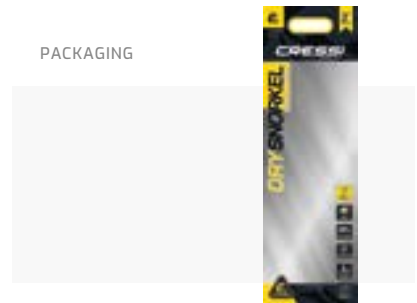

CODE	COLOR	CASE PACK
ES290020	Clear/Blue	6
ES290040	Clear/Pink	6
ES290050	Clear/Black	6
ES290058	Clear/Red	6
ES290109	Black/Gold	6
ES290120	Black/Blue	6
ES290150	Black/Black	6
ES290158	Black/Red	6

### SPARE PARTS

CODE	PRODUCT
EZ267015	SNORKEL KEEPER for ALPHA ULTRA DRY/BETA - GREY
EZ270017	MOUHPICE for ALPHA/BETA/CORFU/ITACA - BLACK
EZ270019	MOUHPICE for ALPHA/BETA/CORFU/ITACA - CLEAR



PATENTED AQUASTOP DRY GUARD WITH 360° DRY PROTECTION TECHNOLOGY



PURGE VALVE



QUICK RELEASE SNORKEL HOLDER

# ALPHA ULTRA DRY

## DRY TOP | PURGE VALVE

It uses the latest dry-top snorkel technology with a compact valve that automatically closes to keep water out regardless of the angle of the snorkel. The Alpha also has a new, highly flexible tube that reduces jaw fatigue and folds compactly for storing in a BC pocket or travel pack. A new, wider elliptical shape increases air flow capacity for more comfortable breathing, while the purge valve enables instant clearing.



BLUE/  
AZURE

BLACK/  
YELLOW

BLACK/  
PINK

WHITE/  
LILAC



BLACK/  
SILVER

BLACK/WHITE/  
BLACK/

BLACK/BLACK/  
BLACK



CODE	COLOR	CASE PACK
ES258020	BLUE/AZURE/CLEAR	6
ES258041	WHITE/LILAC/CLEAR	6
ES258051	BLACK/YELLOW/CLEAR	6
ES258054	BLACK/PINK/CLEAR	6
ES258055	BLACK/SILVER/CLEAR	6
ES258130	BLACK/WHITE/BLACK	6
ES258150	BLACK/BLACK/BLACK	6

### SPARE PARTS

CODE	PRODUCT
E2267015	SNORKEL KEEPER for ALPHA ULTRA DRY/BETA - GREY
E2270017	MOUTHPIECE for ALPHA/BETA/CORFU/ITACA - BLACK
E2270019	MOUTHPIECE for ALPHA/BETA/CORFU/ITACA - CLEAR



### TECHNICAL FEATURES

- Dry Valve technology seals breathing tube when submerged at any angle
- Flexible tube allows folding for storage
- Mouthpiece drops away when not in use: great for scuba divers
- Angled mouthpiece reduces jaw fatigue
- Lower purge valve allows any water to be quickly expelled
- Streamlined design reduces drag while swimming
- Adjustable snorkel keeper for securing to any mask

ULTRA  
FLEXIBLE  
TUBE



ANGLE DRY  
PROTECTION  
TECHNOLOGY

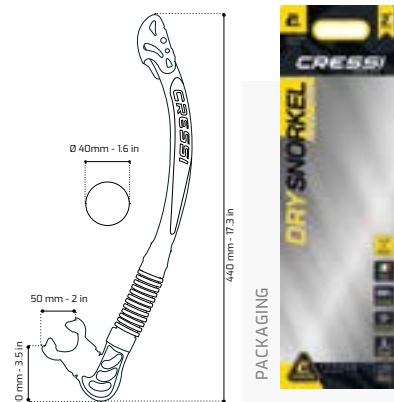

# SUPERNOVA DRY

DRY TOP | PURGE VALVE



CLEAR/  
YELLOW

CLEAR/  
COBALT

CLEAR/  
WHITE

CLEAR/  
PINK

CLEAR/  
BLACK

CLEAR/  
BLUE

CLEAR/  
LILAC

BLACK/  
YELLOW

BLACK/  
BLUE

BLACK/  
BLACK

BLACK/  
RED

## TECHNICAL FEATURES

- Dry-top valve seals breathing tube when submerged
- Flexible lower bore reduces jaw fatigue
- Mouthpiece drops away when not in use great for scuba divers
- High quality silicone mouthpiece is comfortable and durable
- Angled mouthpiece reduces jaw fatigue
- Lower purge valve allows water to be quickly expelled
- Streamlined design reduces drag while swimming
- Adjustable snorkel keeper for securing to any mask



DRY GUARD



PURGE VALVE

CODE	COLOR	CASE PACK
ES259010	CLEAR/YELLOW	50
ES259020	CLEAR/COBALT	50
ES259030	CLEAR/WHITE	50
ES259040	CLEAR/PINK	50
ES259050	CLEAR/BLACK	50
ES259062	CLEAR/BLUE	50
ES259080	CLEAR/LILAC	50
ES259510	BLACK/YELLOW	50
ES259520	BLACK/BLUE	50
ES259550	BLACK/BLACK	50
ES259558	BLACK/RED	50

### SPARE PARTS

CODE	PRODUCT
EZ267018	SNORKEL KEEPER for SUPERNOVA DRY/TAO/TAO DRY - BLACK
EZ267018W	SNORKEL KEEPER for SUPERNOVA DRY/TAO/TAO DRY - WHITE
EZ270022	MOUTHPIECE for SUPERNOVA DRY/TAO/TAO DRY - BLACK
EZ270024	MOUTHPIECE for SUPERNOVA DRY/TAO/TAO DRY - CLEAR

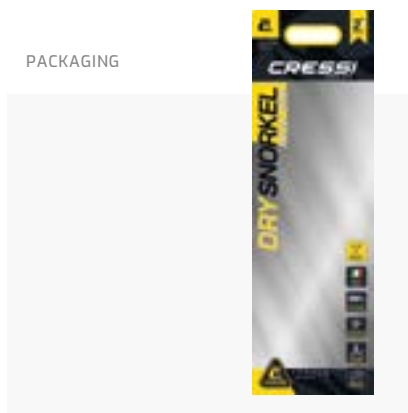

PACKAGING



# TAO DRY NEW COLOR 2024

## DRY TOP | PURGE VALVE

It is a dry snorkel that allows divers to take every breath with confidence and focus on the reef below not worrying about water in your airway. The top has a splash guard and a float mechanism that prevents entry of water when submerged. A generous bore contoured tube provides ample airflow and a lower purge valve enables instant clearing when needed. The snorkel keeper allows attaching the snorkel to the mask strap, avoiding losing it on the surface or during diving. The keeper features a quick release system, just push the button to release the snorkel from the mask. Really a great idea and very simple to use.

### TECHNICAL FEATURES

- Dry-top valve seals breathing tube when submerged
- Flexible lower bore reduces jaw fatigue
- High-quality silicone mouthpiece is comfortable and durable
- Angled mouthpiece reduces jaw fatigue
- Lower purge valve allows water to be quickly expelled
- Removable adjustable snorkel keeper for securing to any mask

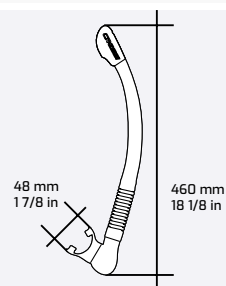

CLEAR/BLUE



TURQUOISE FLUO



PINK FLUO



2024 - CATALOG

CRESSI

CODE	COLOR	CASE PACK
ES261002	TAO DRY - CLEAR/BLUE	10
<span style="background-color: yellow;">NEW</span> ES261028	TAO DRY - TURQUOISE FLUO	10
<span style="background-color: yellow;">NEW</span> ES261045	TAO DRY - PINK FLUO	10

#### SPARE PARTS

CODE	PRODUCT
EZ267018	SNORKEL KEEPER for SUPERNOVA DRY/TAO/TAO DRY - BLACK
EZ267018W	SNORKEL KEEPER for SUPERNOVA DRY/TAO/TAO DRY - WHITE
EZ270022	MOUTHPIECE for SUPERNOVA DRY/TAO/TAO DRY - BLACK
EZ270024	MOUTHPIECE for SUPERNOVA DRY/TAO/TAO DRY - CLEAR



POLYBAG

# TAO

## SEMI-DRY TOP | PURGE VALVE

It is a semi-dry snorkel that allows divers to take every breath with confidence and focus on the reef below not on worrying about water in the air way. The top Splash Guard is designed to reduce water intake. A generous bore contoured tube provides ample airflow and a lower purge valve enables instant clearing when needed.



CLEAR/BLACK

BLACK/BLACK



### TECHNICAL FEATURES

- Profiled splash guard significantly reduces water entry
- Flexible lower bore reduces jaw fatigue
- High-quality silicone mouthpiece is comfortable and durable
- Angled mouthpiece reduces jaw fatigue
- Lower purge valve allows water to be quickly expelled
- Removable adjustable snorkel keeper for securing to any mask

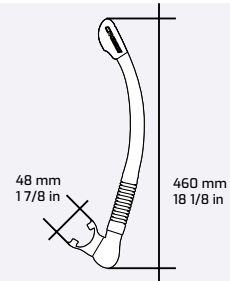

CODE	COLOR	CASE PACK
E5260050	Clear/Black	10
E5260550	Black/Black	10

### SPARE PARTS

CODE	PRODUCT
E2267018	SNORKEL KEEPER for SUPERNOVA DRY/TAO/TAO DRY - BLACK
E2267018W	SNORKEL KEEPER for SUPERNOVA DRY/TAO/TAO DRY - WHITE
E2270022	MOUTHPIECE for SUPERNOVA DRY/TAO/TAO DRY - BLACK
E2270024	MOUTHPIECE for SUPERNOVA DRY/TAO/TAO DRY - CLEAR

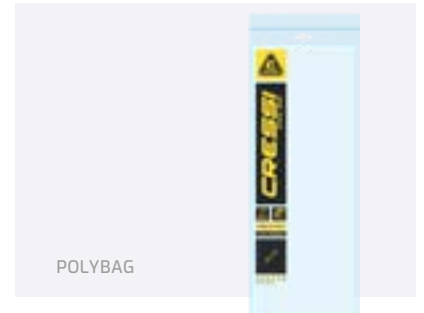

POLYBAG

# F-DUAL + TAO DRY

NEW 2024

F-DUAL MASK | TAO DRY SNORKEL



## TECHNICAL FEATURES

- **MASK**
  - Frameless technology for maximum comfort
  - Single tempered glass lens
  - Wide field of view
  - High-grade soft silicone
  - Double feathered edge skirt
  - Quick-adjustable strap buckles
  - Easy-access nose pocket for 1-handed ear equalization
- **SNORKEL**
  - Dry-top valve seals breathing tube when submerged
  - Flexible lower bore reduces jaw fatigue
  - Mouthpiece drops away when not in use great for scuba divers
  - High-quality silicone mouthpiece is comfortable and durable
  - Angled mouthpiece reduces jaw fatigue
  - Lower purge valve allows water to be quickly expelled
  - Streamlined design reduces drag while swimming
  - Adjustable snorkel keeper for securing to any mask



TURQUOISE/CLEAR

BLACK/BLACK

CLEAR/PUNK FLUO



PACKAGING

CODE	COLOR
DM410040	F-DUAL & TAO DRY COMBO - CLEAR/PINK FLUO
DM410045	F-DUAL & TAO DRY COMBO - CLEAR/TURQUOISE
DM415050	F-DUAL & TAO DRY COMBO - BLACK/BLACK





# F-DUAL + SUPERNOVA DRY

F-DUAL MASK | SUPERNOVA DRY SNORKEL



## TECHNICAL FEATURES

- **MASK**
  - Frameless technology for maximum comfort
  - Single tempered glass lens
  - Wide field of view
  - High-grade soft silicone
  - Double feathered edge skirt
  - Quick-adjustable strap buckles
  - Easy-access nose pocket for 1-handed ear equalization
- **SNORKEL**
  - Dry-top valve seals breathing tube when submerged
  - Flexible lower bore reduces jaw fatigue
  - Mouthpiece drops away when not in use great for scuba divers
  - High-quality silicone mouthpiece is comfortable and durable
  - Angled mouthpiece reduces jaw fatigue
  - Lower purge valve allows water to be quickly expelled
  - Streamlined design reduces drag while swimming
  - Adjustable snorkel keeper for securing to any mask

F-Dual mask: unique design with silicone skirt and tempered glass lens. Low internal volume, quick-adjust strap buckles, and wide split strap design for comfort and proper seal. Supernova Dry snorkel: splash guard reduces water entry on surface. Valve at top seals tube when submerged. Corrugated piece keeps snorkel away from mouth during diving. Water collection well expels water easily. Angled mouthpiece and tube made of Hypoallergenic Silicone. Quick-release snorkel keeper and ergonomic shape.



CLEAR/BLUE

WHITE/PINK

BLACK/BLUE

BLACK/WHITE

BLACK/RED

## PACKAGING



CODE	COLOR	CASE PACK
DM330020	Clear/Blue	20
DM333430	White/Pink	20
DM335020	Black/Blue	20
DM335030	Black/White	20
DM335080	Black/Red	20



SNORKEL KEEPER

Alpha Ultra Dry · Itaca Ultra Dry · Beta · Corfù



CODE	COLOR
EZ267015	Black

SNORKEL KEEPER

Supernova Dry · Tao Dry · Tao



CODE	COLOR
EZ267018	Black
EZ267018W	White

SNORKEL KEEPER

Corsica · Mexico · Gamma



CODE	COLOR
EZ267005	Black
EZ267009	Clear

SNORKEL KEEPER

Gringo



CODE	COLOR
EZ260003	Black
EZ265003	Clear

SNORKEL KEEPER

America · Top



CODE	COLOR
EZ267004	Black
EZ267011	Clear

SNORKEL KEEPER

Mini Dry



CODE	COLOR
EZ267019B	Black
EZ267019	White

SNORKEL KEEPER

Kappa · Sigma



CODE
EZ267013

BARBEL SNORKEL KEEPER

Universal



CODE
EZ267013B

SNORKEL MOUTHPIECE

ALPHA ULTRA DRY • ITACA ULTRA DRY •  
BETA • CORFU



CODE COLOR

EZ270017 Black

EZ270019 Clear

GAMMA • KAPPA • SIGMA



CODE COLOR

EZ270001 Clear

EZ270002 Black

AMERICA



CODE COLOR

EZ270006 Black

EZ270005 Clear

MINIGRINGO



CODE COLOR

EZ270010 Clear

SUPERNOVA DRY • TAO DRY • TAO



CODE COLOR

EZ270022 Black

EZ270024 Clear

EZ270039 Yellow

EZ270040 Blue

EZ270041 Pink

EZ270044 Lilac

GRINGO



CODE COLOR

EZ270007 Black

EZ270008 Clear

TOP



CODE COLOR

EZ270036 Clear

CORSICA • MEXICO



CODE COLOR

EZ270029 Black

EZ270031 Clear

EZ270120 Blue

Metal

EZ270130 White

CALIFORNIA



CODE COLOR

EZ270012 Black

MINI DRY



CODE COLOR

EZ270026 Clear

ELLIPTICAL PURGE VALVE FOR SNORKEL

CODE

EZ270015





# BORG

BLUNT TIP

**304** JAPANESE  
STEEL

Version of the Borg knife with the chisel tip to allow it to be used as a tool for various operations and avoid accidental damage caused by a sharp tip.

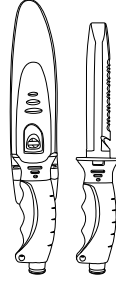

- One side of the stainless steel blade is straight-edged, the other one is serrated right along the blade: they are both very sharp and effective for line cutting
- It is separated from the blade by a small technopolymer thumb tab
- Sheath with locking mechanism to allow one-hand release
- The knife is supplied with two leg straps



PACKAGING

**CODE**      **CASE PACK**

RC559150      10

# GRIP

BLUNT TIP

Grip Blunt Tip Knife is a small-sized knife with a blunt tip and two different types of blades for multi-use. Great for scuba diving, as primary knife or back-up.

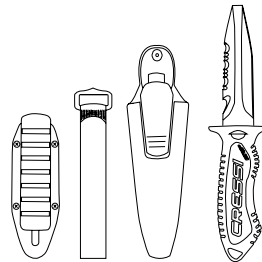

PACKAGING

- Kit included
- High quality Japanese stainless steel
- Dagger style blade with pointed tip
- Smooth cutting blade that is lightweight, but strong
- Small, easy release sheath features one-handed operation
- Serrated top blade for easy underwater cutting
- Opening at base of handle for easy lanyard attachment
- Rear plate for bc strap attachment bc hose mounting

**CODE**      **CASE PACK**

RC559410      5

# CLEAN-UP TOOLS

## LINE CUTTER

Simple, efficient line cutting tool with safety-blade design. The sheath can be mounted on harness rig or on a B.C.D.

- STAINLESS STEEL SERRATED BLADE
- QUICK-RELEASE SHEATH



CODE

RC555500

NEW  
2024

## HAKA

Machine serrated cutting edge for tearing through tough situations. Easy grip providing maximum mechanical leverage for cutting through even the toughest materials.

420 JAPANESE  
420 STEEL



- 420 STAINLESS STEEL
- SERRATED CUTTING EDGE
- MULTIPURPOSE EQUIPMENT
- SMOOTH CUTTING BLADE THAT IS LIGHTWEIGHT, BUT STRONG
- HEAVY-DUTY CONSTRUCTION
- ULTIMATE CUTTING EDGE

PACKAGING



CODE

CASE PACK

RC580050

10

## ALLIGATOR

2 IN 1: KNIFE/SCISSORS

Knife-scissors very practical for all types of operations underwater. Made of high-strength stainless steel, it is helpful as scissors, as a knife with a smooth edge blade, or as a saw blade, and also has a valuable recess as a wire cutter. Includes serration for use as pliers. Compared to other similar knives, it has the advantage of its contained size and its full use and ergonomics without having to open it to cut efficiently using it as a knife. Excellent cutting capacity and oxidation resistance.

420 JAPANESE  
420 STEEL

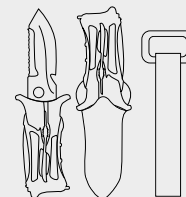

- BLADE LENGTH: 8,6 cm - 3,38 inch
- TOTAL LENGTH: 17,5 cm - 6,88 inch
- BLADE WIDTH: 26 mm - 1,02 inch
- BLADE THICKNESSES: 6 mm - 0,23 inch
- KNIFE-ONLY WEIGHT: 125 gr - 0,27 lb
- WEIGHT WITH SHEATH: 164 gr - 0,36 lb

PACKAGING



CODE

RC559200

## PRO HD SMB



This SMB is built to resist in any condition. It can be inflated in three ways and has an internal "duck bill" heat welding to prevent accidental emptying. The top is reflective and has an insert for fixing a light. It also features a mini overpressure valve and a lead base for maintaining verticality. It's easy to roll and remove with a double elastic band closure.

- Made of 210D resin-coated nylon with an internal coating of heat-welded polyurethane and sewn with a reinforcement trim
- 3 inflation systems
- Internal "duck bill" heat welding
- Rollable on itself without lining, for quick removal, and with double elastic band closure
- Lead base to maintain verticality
- High visibility color
- Top reflective band
- DIR carabiner
- Dimensions: 120 cm | 47 1/4 in long, 15 cm | 5 7/8 in wide



CODE	COLOR
BTA611905	RED

## CLUB HD DIVER BELOW BUOY



Professional SMB made of resin-coated nylon with heat-welded polyurethane injection. Inflates through scuba regulator. Rollable and easy to remove with double elastic band closure.

- Made of resin-coated nylon with an internal injection of heat-welded polyurethane and sewn with a reinforcement trim
- Rollable on itself without lining, for quick removal, and with double elastic band closure
- Lead base to maintain verticality
- High visibility color
- ABS carabiner
- Dimensions: 120 cm | 47 1/4 in long, 15 cm | 5 7/8 in wide

CODE	COLOR
BTA611899	RED

## FLOAT LINE WINDER

The buoy line folder is an essential accessory for regulating the amount of buoy floating line you need throughout the day. Made of semi-flexible plastic material, it's resistant, lightweight, and highly visible. It has a solid structure, a handle, and an oversized horn, allowing for quick release. The folder has four paired fairleads, two closed, and two snap-lock.

- Made of semi-flexible resistant plastic material
- Integrated handle
- 4 paired fairleads
- 1 oversized horn
- Buoyant
- Width: 30 cm | 11 3/4 in
- Up to 70 m | 229'8" with 6 mm rope



CODE	COLOR
ETA613000A	YELLOW



# COMBO BAG

51.2 cm | 20.2 in



CODE      COLOR  
 US450032      BLACK/SILVER

# SPIDER MESH BAG

The Spider Mesh Bag is great when you need to carry your wet scuba gear or your snorkeling equipment. Thanks to its net design, it lets the equipment dry fast. The mesh is made of strong polyester fabric, a material that resists weight and dries quickly. It has a high storage capacity, enough for carrying a complete scuba set (BCD, regulator, gauges, octopus) and even mask, fins and snorkel and also wetsuits. It features a drawstring closure with a barrel lock fastener.

· Dimensions: 61 x 91 cm | 24 x 36 in



CODE      CASE PACK  
 UB939000      10

# NET BAG FOR SNORKELING SET

[75cm/29.5in]

Net Bag made in strong long lasting nylon fabric ideal for carry snorkeling equipment. The bag features a drawstring closure with barrel lock fastener. The net style mesh allows you to rinse the snorkeling equipment while still in the bag and hang to drip dry after use. The bag contains scuba or snorkeling fins, mask and snorkel.

· The bag is long 75 cm | 29.5 in and wide 27.5 cm | 10.6 in



CODE  
 BZ175003



**WETSUITS**  
SCUBA



# DESERT

DRYSUIT WITH LIQUID SEAL TECHNOLOGY



SMOOTH SKIN NEOPRENE (NECK, WRISTS)

ULTRA DURABLE X-DIAMOND PAD (SHOULDERS, CHEST, KNEES)

HIGH VOLUME POCKET D-RING AND HOOD HOLDER

SOFT NEOPRENE SOCKS



Comfortable and resistant drysuit thanks to its 4 mm thick High-Density pre-compressed Neoprene and the special Liquid Seal protected stitched joints. The seams and outer neoprene lining are covered with a special layer of elastomer to simultaneously create an impermeable obstacle for the water and increase resistance at the joints. On the inside, an additional sealing strip guarantees total waterproofability. This double-sealing system has been carefully designed to meet the needs of the most discerning and seasoned divers who often require their dry suits to adapt to extreme working or weather conditions.

The special Spanflex material has also been used in the outer part to increase elasticity and abrasion resistance. The cuffs are made of smooth 3.5 mm-thick neoprene on the inside to improve sealability and from Ultraspan on the outside to improve elasticity. The collar is made of the same materials but with 2.5mm-thick neoprene for more comfort and breathability when turned up. The shoulder neck and knee lines are reinforced with a special anti-abrasion X-Diamond Pad lining. Includes a practical wide leg pocket and comfortable hood.

MAN

CODE	SIZE	CASE PACK
LQ401002	S	1
LQ401003	M	1
LQ401004	L	1
LQ401005	XL	1
LQ401006	2XL	1
LQ401007	3XL	1

LADY

CODE	SIZE	CASE PACK
LQ401101	XS	1
LQ401102	S	1
LQ401103	M	1
LQ401104	L	1
LQ401105	XL	1

ACCESSORIES

CODE	PRODUCT
UB953000	CHANGING MATBAG FOR WETSUIT/DRYSUIT

SPARE PARTS

CODE	PRODUCT
LZ400001	DRYSUIT CHEST INFLATOR VALVE COMPLETE
LZ400002	DRYSUIT SHOULDER DEFLATE VALVE COMPLETE

TECHNICAL FEATURES

- High-density 4 mm thick pre-compressed neoprene
- Soft neoprene socks
- Internal suspender system
- Fly with concealed zip
- Zipper made by BDM, a YKK company
- Heavy duty kneepads
- Side action rotating inflation valve
- Adjustable discharge relief valve



HOOD AND HOSE INCLUDED



LIQUID SEAL TECHNOLOGY

A layer of polymer is spread along the seams to protect and seal them, thereby increasing the resistance to wear, the lifetime of the suit, and its insulating power.





**ICE** NEW 2024

**SEMI-DRYSUIT 7 mm**



HORIZONTAL DRY BACK TIZIP® MASTERSEAL



ELASTIC-SPAN  
ELASTIC PLUSH INSIDE



HIGH VOLUME POCKET  
D-RING HOOD HOLDER

ANKLES AND WRISTS  
WITH DOUBLE CUFFS

**TECHNICAL FEATURES**

- 7 mm-thick neoprene
- Elastic-span
- Elastic plush inside
- High volume pocket d-ring and hood holder
- Ankles and wrists with double cuffs



HORIZONTAL DRY BACK TIZIP® MASTERSEAL



HIGH VOLUME POCKET D-RING AND HOOD HOLDER

One-piece 7 mm semi-dry suit for cold water. Very easy to wear thanks to special outer ELASTIC SPAN cover and internal ELASTIC PLUSH lining. To facilitate the diver who carries important accessories, the suit is equipped with a convenient double compartment side pocket. One of them has a zipper closure while the other, intended for objects needing faster retrieved, has a Velcro closing. Two D-RINGS allow you to secure objects. It has a HOOD HOLDER for attaching the hood and special SMALL DYMOND anti-abrasion reinforcements on the shoulders, knees and on the back side. Double cuffs on wrists and ankles. Comfortable waterproof MASTER SEAL rear zip.



HOOD INCLUDED

7° - 12° C  
45° - 54° F

SUGGESTED WATER TEMPERATURE

2024 - CATALOG

MAN

CODE	SIZE	CASE PACK
LQ403002	S	1
LQ403003	M	1
LQ403004	L	1
LQ403005	XL	1
LQ403006	2XL	1
LQ403007	3XL	1

LADY

CODE	SIZE	CASE PACK
LQ403101	X5	1
LQ403102	S	1
LQ403103	M	1
LQ403104	L	1
LQ403105	XL	1

CRESSI



# FAST

7 mm



### TECHNICAL FEATURES

- One-piece wetsuit in 7 mm double lined neoprene
- Ultraspan neoprene on arms and calves
- Pre-shaped legs
- YKK back zip with under zip lining and water-stop system
- Anti-abrasion reinforcement on the knees
- Wrists and ankles with water-stop system / watertight seals



WATERTIGHT SEALS



UNDER ZIP LINING



NEW DESIGN KNEEPAD



Stylish, warm and versatile, the Fast can be used in the widest range of temperate and cold waters. Durable 7 mm, double-lined neoprene, stands up well to compression at depth for maximum heat retention. Pre-shaped legs improve flexibility for easier kicking.

MAN

CODE	SIZE	CASE PACK
LR108702	S	5
LR108703	M	5
LR108704	L	5
LR108705	XL	5
LR108706	2XL	5
LR108707	3XL	5

LADY

CODE	SIZE	CASE PACK
LR109701	XS	5
LR109702	S	5
LR109703	M	5
LR109704	L	5
LR109705	XL	5



# FAST

NEW  
2024

5 mm



16° - 24° C  
61° - 75° F

SUGGESTED WATER TEMPERATURE

## TECHNICAL FEATURES

- One-piece wetsuit in 5 mm double lined neoprene
- Pre-shaped legs
- YKK back zip with under zip lining and water-stop system
- Anti-abrasion reinforcement on the knees
- Wrists and ankles with water-stop system / watertight seals



WATERTIGHT SEALS



UNDER ZIP LINING



NEW DESIGN KNEEPAD

Stylish, warm and versatile, the Fast can be used in the widest range of temperate waters. Durable 5 mm, double-lined neoprene, stands up well to compression at depth for maximum heat retention. Pre-shaped legs improve flexibility for easier kicking.

MAN

CODE	SIZE	CASE PACK
LR108502	FAST 5mm MAN - BLACK/YELLOW [S]	5
LR108503	FAST 5mm MAN - BLACK/YELLOW [M]	5
LR108504	FAST 5mm MAN - BLACK/YELLOW [L]	5
LR108505	FAST 5mm MAN - BLACK/YELLOW [XL]	5
LR108506	FAST 5mm MAN - BLACK/YELLOW [2XL]	5
LR108507	FAST 5mm MAN - BLACK/YELLOW [3XL]	5

LADY

CODE	SIZE	CASE PACK
LR109501	FAST 5mm LADY - BLACK/YELLOW [XS]	5
LR109502	FAST 5mm LADY - BLACK/YELLOW [S]	5
LR109503	FAST 5mm LADY - BLACK/YELLOW [M]	5
LR109504	FAST 5mm LADY - BLACK/YELLOW [L]	5
LR109505	FAST 5mm LADY - BLACK/YELLOW [XL]	5



# FAST

3 mm



22° - 25° C  
72° - 77° F

SUGGESTED WATER TEMPERATURE

## TECHNICAL FEATURES

- One-piece wetsuit in 3 mm double-lined neoprene
- Pre-shaped legs
- YKK back zip with under zip lining
- Anti-abrasion reinforcement on the knees

UNDER  
ZIP LINING

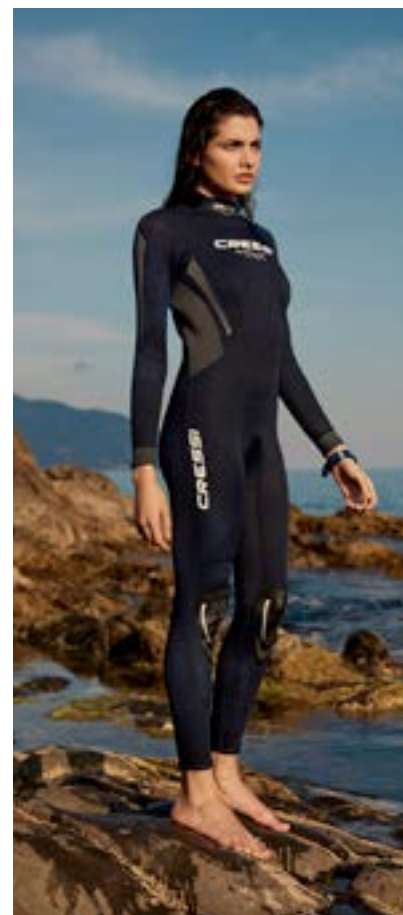

Stylish, warm and versatile, the Fast can be used in the widest range of temperate waters. Durable 3 mm neoprene, pre-shaped legs improve flexibility for easier kicking and anti-abrasion reinforcement on the knees.

### MAN

CODE	SIZE	CASE PACK
LR108302	S	5
LR108303	M	5
LR108304	L	5
LR108305	XL	5
LR108306	2XL	5
LR108307	3XL	5

### LADY

CODE	SIZE	CASE PACK
LR109301	XS	5
LR109302	S	5
LR109303	M	5
LR109304	L	5
LR109305	XL	5
LR109306	2XL	5

# MOREA

3 mm



22° - 25° C  
72° - 77° F

SUGGESTED WATER TEMPERATURE



PREMIUM  
ULTRA STRETCH  
NEOPRENE  
ON ARMS



PREMIUM  
ULTRA STRETCH  
NEOPRENE  
ON LEGS

## TECHNICAL FEATURES

- 3 mm neoprene with Ultraspan ends on the arms and legs.
- Rubberized neoprene on the chest and protection on the knees.
- 20° Anatomic shape neck closure



This is the perfect suit for diving in tropical waters. It offers excellent protection against abrasion, while at the same time ensuring the thermal protection needed for snorkelers, free-divers, and divers. Also excellent as a protective garment for any water sport. It is made of Premium Quality Neoprene thick 3 mm to ensure warmth. The arms and legs are made of

Ultraspan Neoprene to ensure free movement and ease of donning. The chest is in Rubberized Neoprene to ensure warmth. The anatomical cuts make the wetsuit adaptable to different shapes of bodies. The knees feature protection against bumps and scratches. The back-zipper is made of the quality YKK.

### MAN

CODE	SIZE	CASE PACK
LU476002	S	5
LU476003	M	5
LU476004	L	5
LU476005	XL	5
LU476006	2XL	5

### LADY

CODE	SIZE	CASE PACK
LU476501	XS	5
LU476502	S	5
LU476503	M	5
LU476504	L	5
LU476505	XL	5



# BALAM

NEW 2024

2.5 mm



## TECHNICAL FEATURES

- One-piece wetsuit in 2.5 mm double lined neoprene
- X-DIAMOND Pad on shoulders, waist and calves
- Pre-shaped legs
- YKK back zip with under zip lining and water-stop system
- Anti-abrasion reinforcement on the knees



GRAPHIC SIZE INDICATOR  
IDEAL FOR RENTAL



...FLEX  
*Area*

Cressi wetsuit designs guarantee complete adherence to the body, just like a second skin. The flex areas facilitate movement, ensuring complete comfort and ease of donning and motion, especially in the arm and ankle areas.

Stylish, warm and versatile, the Balam can be used in the widest range of temperate waters. Durable 2.5 mm, double-lined neoprene, stands up well to compression at depth for heat retention. Pre-shaped legs improve flexibility for easier kicking. With X-Diamond pads for reinforcement.

MAN

CODE	COLOR	SIZE
LR142522	Black/Blue	S
LR142523	Black/Blue	M
LR142524	Black/Blue	L
LR142525	Black/Blue	XL
LR142526	Black/Blue	2XL
LR142527	Black/Blue	3XL

LADY

CODE	COLOR	SIZE
LR152521	Black/Turquoise	XS
LR152522	Black/Turquoise	S
LR152523	Black/Turquoise	M
LR152524	Black/Turquoise	L
LR152525	Black/Turquoise	XL
LR152526	Black/Turquoise	2XL

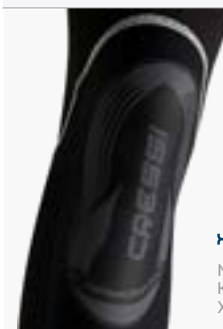

X DIAMOND PAD

NEW DESIGN  
KNEEPAD WITH  
X-DIAMOND PAD



# BAHIA FLEX

2.5 mm



The Bahia Flex 3mm is the successor of the Bahia front-zip full wetsuit. This model is redesigned to ensure total freedom of movement and can be used in any water sport. The wetsuit features separate anatomical cuts for both men and women. The front-zip, made of metal YKK®, ensures ease of donning and doffing. The cut is designed to guarantee complete adherence to the body, just like a second skin. The Flex areas facilitate movement, ensuring complete comfort. A small difference between

thickness makes donning and movement easier, particularly in the arms and ankle areas. Cuff seals prevent water entry while swimming and the double-lined Neoprene resists compression at depth. The double-lining is more durable than the single-lining of other competitor's wetsuit. The knee and shin area is reinforced to protect the wetsuit against accidental scratches. The Aquastop wrist and ankle seals limit water exchange.

MAN

CODE	SIZE	CASE PACK
LV471001	XS	10
LV471002	S	10
LV471003	M	10
LV471004	L	10
LV471005	XL	10
LV471006	2XL	10
LV471007	3XL	10

LADY

CODE	SIZE	CASE PACK
LV472001	XS	10
LV472002	S	10
LV472003	M	10
LV472004	L	10
LV472005	XL	10
LV472006	2XL	10

## TECHNICAL FEATURES

- Front-zip full wetsuit
- YKK zipper
- Made of flexible double-lined Neoprene 3 mm thick
- Overlock stitching cuffs
- Reinforced knee areas

26° - 28° C  
79° - 82° F

SUGGESTED WATER TEMPERATURE

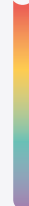

# LIDO LONG

2 mm



The easy-entry, front zipper placement of the Lido makes it effortless to put on. It is perfect for snorkeling, diving in tropical waters, swimming, surfing and other activities. Highly flexible 2 mm Neoprene and a flattering cut conform easily to most

body shapes for a great fit. The absence of seams under the arms prevents the intrusion of water. Fabric cuts are anatomical for both men and women. The legs and sleeves are finished with a simple, economic, and reliable Overlock cuff.

MAN

CODE	SIZE	CASE PACK
LV452001	XS	10
LV452002	S	10
LV452003	M	10
LV452004	L	10
LV452005	XL	10
LV452006	2XL	10
LV452007	3XL	10

LADY

CODE	SIZE	CASE PACK
LV454001	XS	10
LV454002	S	10
LV454003	M	10
LV454004	L	10
LV454005	XL	10
LV454006	2XL	10

## TECHNICAL FEATURES

- Full front-zip wetsuit
- Double-lined neoprene for durability and warmth
- Anatomical cuts
- Quality YKK zipper for durability

26° - 28° C  
79° - 82° F

SUGGESTED WATER TEMPERATURE





# FAST

NEW 2024

1 mm



ANATOMICAL CUTS

Stylish, warm and versatile, the Fast can be used in the widest range of temperate waters. Durable 1 mm, double-lined neoprene, stands up well to compression at depth for maximum heat retention. Pre-shaped legs improve flexibility for easier kicking.

MAN

CODE	SIZE	CASE PACK
LR108902	S	5
LR108903	M	5
LR108904	L	5
LR108905	XL	5
LR108906	2XL	5
LR108907	3XL	5

LADY

CODE	SIZE	CASE PACK
LR109101	XS	5
LR109102	S	5
LR109103	M	5
LR109104	L	5
LR109105	XL	5
LR109106	2XL	5

## TECHNICAL FEATURES

- One-piece wetsuit in 1 mm double lined neoprene
- Ultraspan neoprene on arms and calves
- Pre-shaped legs
- YKK back zip with under zip lining
- Anti-abrasion reinforcement on the knees



Cressi wetsuit designs guarantee complete adherence to the body, just like a second skin. The flex areas facilitate movement, ensuring complete comfort and ease of donning and motion, especially in the arm and ankle areas.

### UNDER ZIP LINING CLOSE

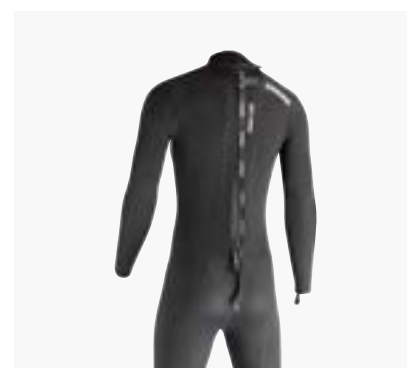

# MED X

2.5 mm

## TECHNICAL FEATURES

- Rear zip
- Adjustable collar with velcro closure
- Children's sizes available

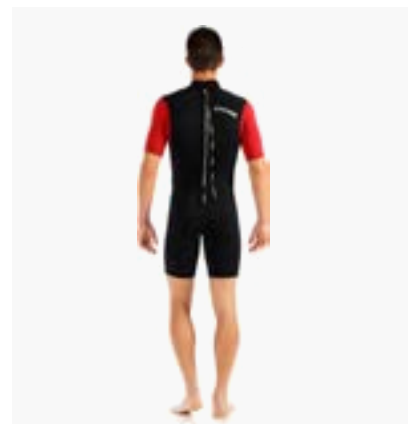

The Med X is an improved version of the popular Tahiti wetsuit. It's a one-piece shorty in 2.5 mm double-lined high stretch ultra span Neoprene with rubberized chest ideal also for surfers. Donning and doffing are made easy with the back zipper closer with a pull tab leash. The Tahiti seams are glued and sewn for strength, warmth, and durability. There are insertions

in flat neoprene on wrists and legs to minimize water filtrations. Perfect for snorkeling, dives in tropical waters, swimming, sailing, and water sports in general. Lightweight and offers a great range of movement and incorporates an adjustable Velcro fastener collar for maximum comfort. It's presented with a new pattern and a new captivating aesthetic.

### MAN

CODE	SIZE	CASE PACK
XLV437081	XS	5
XLV437082	S	5
XLV437083	M	5
XLV437084	L	5
XLV437085	XL	5
XLV437086	2XL	5
XLV437087	3XL	5

### LADY

CODE	SIZE	CASE PACK
XLV437591	XS	5
XLV437592	S	5
XLV437593	M	5
XLV437594	L	5
XLV437595	XL	5
XLV437596	2XL	5

# BAULA NEW 2024

2.5 mm



X-DIAMOND PAD

Stylish, warm and versatile, the Baula can be used in the widest range of temperate waters. Durable 2.5 mm, double-lined neoprene, stands up well to compression at depth for heat retention. Pre-shaped legs improve flexibility for easier kicking. With X-Diamond pads for reinforcement.

MAN

CODE	SIZE	CASE PACK
UV457001	XS	5
UV457002	S	5
UV457003	M	5
UV457004	L	5
UV457005	XL	5
UV457006	2XL	5
UV457007	3XL	5

LADY

CODE	SIZE	CASE PACK
UV457101	XS	5
UV457102	S	5
UV457103	M	5
UV457104	L	5
UV457105	XL	5
UV457106	2XL	5

## TECHNICAL FEATURES

- One-piece wetsuit in 2.5 mm double lined neoprene
- X-DIAMOND Pad on shoulders, waist and calves
- Pre-shaped legs
- YKK back zip with under zip lining and water-stop system
- Anti-abrasion reinforcement on the knees

26° - 28° C  
79° - 82° F

SUGGESTED WATER TEMPERATURE

**X-DIAMOND PAD**  
Cressi wetsuit designs guarantee complete adherence to the body, just like a second skin. The flex areas facilitate movement, ensuring complete comfort and ease of donning and motion, especially in the arm and ankle areas.



GRAPHIC SIZE INDICATOR  
IDEAL FOR RENTAL



UNDER ZIP LINING CLOSE

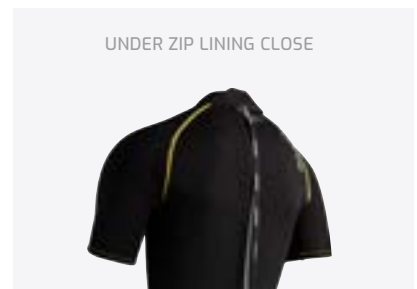



# PLAYA FLEX

3 mm



## TECHNICAL FEATURES

- One-piece short wetsuit
- 2.5 mm double-lined high stretch ultraspan
- Ultra span neoprene decreases water exchange
- Provides UV protection
- Front-zip for easy donning and doffing

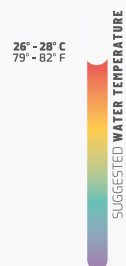

The Playa Flex is the successor of the Playa front-zip short wetsuit. The cut is designed to guarantee complete adherence to the body, just like a second skin. The Flex areas facilitate movement, ensuring complete comfort. A small difference between thickness makes donning and movement easier, particularly in the arms and ankle areas. The wetsuit features separate anatomical cuts for both men and women. This model is redesigned to ensure total

freedom of movement and to be used in any water sport. The front-zip, made of metal YKK®, ensures ease of donning and doffing. Divers will appreciate the high-quality double-lined Neoprene, which retains its shape and insulating ability at depth. The Playa Flex is perfect for snorkeling, diving in tropical water, swimming, sailing and all water sports in general. The arms and legs are made with an elastic Neoprene Ultraspan® braided seal to minimize water infiltration.

### MAN

CODE	SIZE	CASE PACK
LV448001	XS	10
LV448002	S	10
LV448003	M	10
LV448004	L	10
LV448005	XL	10
LV448006	2XL	10
LV448007	3XL	10

### LADY

CODE	SIZE	CASE PACK
LV449001	XS	10
LV449002	S	10
LV449003	M	10
LV449004	L	10
LV449005	XL	10
LV449006	2XL	10

# LIDO SHORT

2 mm



## TECHNICAL FEATURES

- Separate anatomical cuts for both men and women
- Double-lined neoprene for durability and warmth
- Front zip entry for easier donning

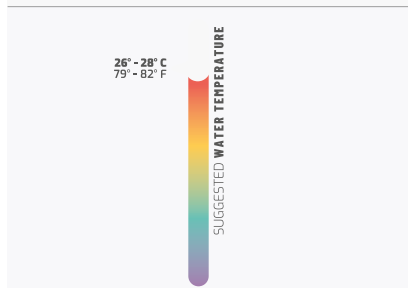

The easy-entry front zipper placement makes the Lido effortless to put on and is perfect for snorkeling, diving in tropical waters, swimming, sailing, and other activities. Highly flexible 2 mm neoprene and a flattering cut conform easily to most body shapes for a great fit.

### MAN

CODE	SIZE	CASE PACK
LV455001	X5	10
LV455002	S	10
LV455003	M	10
LV455004	L	10
LV455005	XL	10
LV455006	2XL	10
LV455007	3XL	10

### LADY

CODE	SIZE	CASE PACK
LV457001	X5	10
LV457002	S	10
LV457003	M	10
LV457004	L	10
LV457005	XL	10
LV457006	2XL	10

# TERMICO LADY

NEOPRENE SWIMSUIT 2 mm



2-mm ULTRASSPAN LINED NEOPRENE

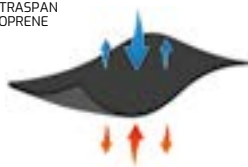

Women's all-in-one suit that is shaped like a one-piece swimsuit in soft 2 mm neoprene. Designed specifically for swimming, snorkeling and water sports in general, it allows great freedom of movement thanks to the special style and elasticity of the material. It is made from double lined 2 mm neoprene and comes with a front zip that makes it easy to put on and take off.

CODE	SIZE	CASE PACK
DG000501	TERMICO LADY - BLACK (XS/1)	10
DG000502	TERMICO LADY - BLACK (S/2)	10
DG000503	TERMICO LADY - BLACK (M/3)	10
DG000504	TERMICO LADY - BLACK (L/4)	10
DG000505	TERMICO LADY - BLACK (XL/5)	10

# CHANGING MATBAG

NEW 2024

FOR WETSUIT/DRYSUIT

Practical bag for drysuit or wetsuit. It can be completely opened and used as a changing mat to avoid contact with the ground and keep the feet clean.



CODE	CASE PACK
UB953000	10





# SKIN

FULLSUIT 1 mm



Crafted from nylon material, the Skin is a versatile and a must-have fullsuit for traveling divers. The high-stretch material is effortless to swim in and naturally conforms to the body to reduce drag. The Skin provides UV protection on the surface and just

the warmth needed for extended snorkeling or diving sessions in tropical waters. A long front zip makes the Skin easy to put on and the suit easily layers under thicker dive wear.

UNISEX

CODE	COLOR	SIZE	CASE PACK
WDG050102	Black/Yellow	S	10
WDG050103	Black/Yellow	M	10
WDG050104	Black/Yellow	L	10
WDG050105	Black/Yellow	XL	10
WDG050106	Black/Yellow	2XL	10
WDG050201	Black/Blue	XS	10
WDG050202	Black/Blue	S	10
WDG050203	Black/Blue	M	10
WDG050204	Black/Blue	L	10
WDG050205	Black/Blue	XL	10
WDG050206	Black/Blue	2XL	10
WDG050207	Black/Blue	3XL	10
WDG050401	Black/Pink	XS	10
WDG050402	Black/Pink	S	10
WDG050403	Black/Pink	M	10
WDG050404	Black/Pink	L	10
WDG050405	Black/Pink	XL	10
WDG050602	Black/Silver	S	10
WDG050603	Black/Silver	M	10
WDG050604	Black/Silver	L	10
WDG050605	Black/Silver	XL	10
WDG050606	Black/Silver	2XL	10
WDG050607	Black/Silver	3XL	10

## TECHNICAL FEATURES

- 86% polyester
- 14% spandex

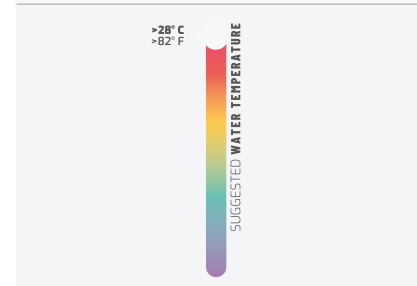

# HOODED VEST

## BASE LAYER

VEST: 2.5 mm | HOOD: 5 mm



Multi thickness neoprene vest, designed to be worn under the wetsuit.

VEST: 2.5 mm  
HOOD: 5 mm

MAN

CODE	SIZE	CASE PACK
LW476212	S	10
LW476213	M	10
LW476214	L	10
LW476215	XL	10
LW476216	2XL	10
LW476217	3XL	10

LADY

CODE	SIZE	CASE PACK
LW476231	XS	10
LW476232	S	10
LW476233	M	10
LW476234	L	10
LW476235	XL	10

# CORE VEST

## BASE LAYER

NEW 2024

2.5 mm

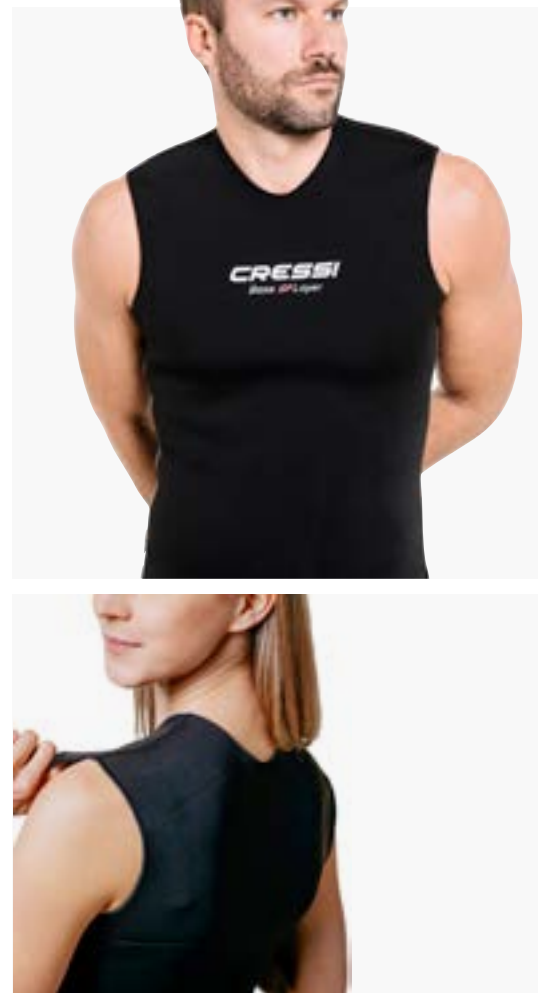

2.5 mm neoprene core vest, designed to be worn under the wetsuit.

MAN

CODE	SIZE	CASE PACK
LW476102	S	10
LW476103	M	10
LW476104	L	10
LW476105	XL	10
LW476106	2XL	10
LW476107	3XL	10

LADY

CODE	SIZE	CASE PACK
LW476111	XS	10
LW476112	S	10
LW476113	M	10
LW476114	L	10
LW476115	XL	10

# SOLO FLEX

MULTI-THICKNESS 7/5 mm



### TECHNICAL FEATURES

- Made entirely of HS200 high stretch neoprene for exceptional comfort and fit
- 7mm HS200 high stretch neoprene cranium and 5mm HS200 high stretch skin-in neoprene face and neck seals
- Face area left unbound to allow for custom trimming
- Unique vent design releases air trapped at the top of the head
- Waterproof glued & blind stitched seams
- Hanging loop located at the top for easy drying
- Designed for use with drysuits
- Descriptive hang tag attached to hanging loop

UNISEX

CODE	SIZE	CASE PACK
LW480202	XS/S	5
LW480203	M	5
LW480205	L/XL	5

# SOLO

3 mm | 5mm



UNISEX 3 mm

CODE	SIZE	STYLE	CASE PACK
LR108132	S	3 mm	10
LR108133	M	3 mm	10
LR108134	L	3 mm	10
LR108135	XL	3 mm	10

UNISEX 5 mm

CODE	SIZE	STYLE	CASE PACK
LR108102	S	5 mm	10
LR108103	M	5 mm	10
LR108104	L	5 mm	10
LR108105	XL	5 mm	10

# SOLO

NEOPRENE 2 mm

The Solo 2mm hood features a smooth neoprene seal along the outline of the face and on the chin area to limit the entrance of water. It also features double lined neoprene and adds extra warmth for colder water diving. The hood's contoured shape provides a better fit and the hood's seams are glued and flat lock stitched for added comfort.



UNISEX

CODE	SIZE	CASE PACK
LW480002	XS/S	10
LW480004	M/L	10
LW480006	2XL	10

# HANDEX

Hood made with strong and elastic synthetic fabric. It protects the head and can be worn under a wetsuit or a rash guard. It is anti UV rays.



CODE	CASE PACK
LW480102	10



# JUTLAND NEW 2024

## NEOPRENE GLOVES 5 mm

Jutland gloves are the ideal accessory for diving practitioners. With a thickness of 5 mm, they offer optimal protection against external agents and abrasions. Their ergonomic design with pre-shaped finger accommodation guarantees a comfortable and secure fit, as well as practicality and ease of use. The distinctive feature of the Jutland gloves is the ultra-grip system that extends over the entire surface area, allowing optimal grip. Reliability, functionality, style, and comfort.



### GLOVES SIZE CHART

SIZE DETAILS  
Pag 430



5 mm

CODE	SIZE	CASE PACK
LX480502	S	10
LX480503	M	10
LX480504	L	10
LX480505	XL	10
LX480506	2XL	10

# CRUZ NEW 2024

## NEOPRENE GLOVES 3 mm

Cruz diving gloves are the perfect companion for exploring the underwater world. At 3 mm thick, they offer optimal protection without sacrificing tactile sensitivity. The ultra grip system on the palm ensures a secure and reliable grip on wet or slippery surfaces. The preformed finger accommodation offers a comfortable fit and facilitates movement. Their practical design and comfortable fit combine functionality and comfort.



### GLOVES SIZE CHART

SIZE DETAILS  
Pag 430



CODE	SIZE	CASE PACK
LX481302	S	10
LX481303	M	10
LX481304	L	10
LX481305	XL	10
LX481306	2XL	10

# HIGH STRETCH GLOVES

2.5 mm | 3.5 mm | 5 mm



5-finger gloves made from single-lined soft, high-stretch neoprene. The inside is covered in Metallite to make them easy to put on. The preformed shape favours the natural position of the hand, with semi-bent fingers. The entire surface is covered with a non-slip finish for a sure grip in all situations.

5 mm

CODE	SIZE	CASE PACK
LX475901	S	10
LX475902	M	10
LX475903	L	10
LX475904	XL	10

3.5 mm

CODE	SIZE	CASE PACK
LX475801	S	10
LX475802	M	10
LX475803	L	10
LX475804	XL	10

2.5 mm

CODE	SIZE	CASE PACK
LX475701	S	10
LX475702	M	10
LX475703	L	10
LX475704	XL	10

# TROPICAL GLOVES

2 mm



Five fingered gloves 2 mm thick Neoprene, made from two different soft and light materials. The palm and finger area uses a light Gray Napa that becomes extraordinarily soft upon contact with the water. However, the upper part of the glove and the wrist area are made from very thin, supple neoprene.

A large area that corresponds to the upper side of the wrist allows for instant adjustment, both before and during the dive. These are particularly suitable gloves when you need the very best touch sensitivity in the fingers. The palm also offers good resistance to abrasions.

CODE	SIZE	CASE PACK
LX475301	S	10
LX475302	M	10
LX475303	L	10
LX475304	XL	10
LX475305	2XL	10



## GLOVES SIZE CHART

SIZE DETAILS  
Pag 430



# THICKNESS GUIDE

## WETSUIT THICKNESS AND WATER TEMPERATURE

- Wetsuit suitability may vary by 5° to 10° F based off the body strength.
- Level of activity, weight and outside temperature

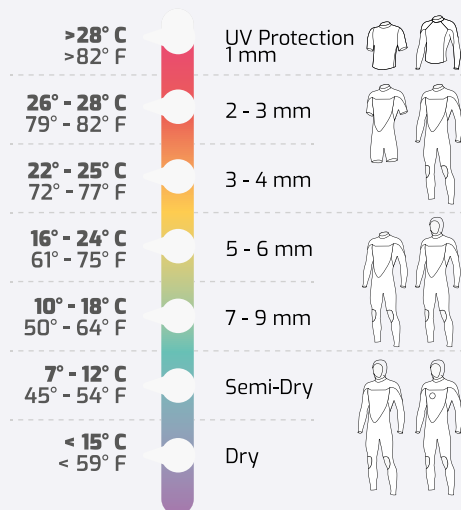

# BALEARI PHS

## 6 mm | PROTECTIVE HARD SOLE



### TECHNICAL FEATURES

- PHS: Protective Hard Sole
- Feet protection against rocks and puncture
- Elastic 6mm Neoprene
- Side YKK zip for donning and doffing
- Fin strap holder on the back



### BOOTS SIZE CHART

SIZE DETAILS  
Pag 431

CODE	SIZE	CASE PACK
ULX436551	5	5
ULX436552	6.5	5
ULX436553	7.5	5
ULX436554	9	5
ULX436555	10	5
ULX436556	11	5
ULX436557	12	5
ULX436558	13.5	5



PACKAGING



# ISLA

7 mm | 5 mm



## TECHNICAL FEATURES

- Built in fin strap holder
- Built in sole to provide extra comfort
- Super elastic neoprene to provide comfort
- Thickness of boot provides toughness while maintaining warmth

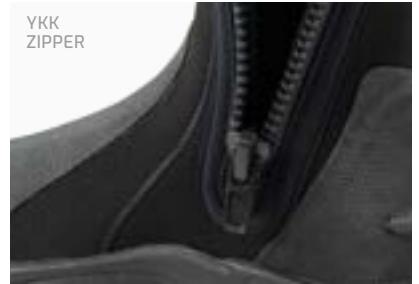

YKK ZIPPER

7 mm

CODE	SIZE	CASE PACK
US051000	5	5
US051001	6	5
US051002	7	5
US051003	8	5
US051004	9	5
US051005	10	5
US051006	11	5
US051007	12	5
US051008	13	5

5 mm

CODE	SIZE	CASE PACK
US050000	5	5
US050001	6	5
US050002	7	5
US050003	8	5
US050004	9	5
US050005	10	5
US050006	11	5
US050007	12	5
US050008	13	5
US050009	14	5



POLYBAG

# BALEARI MD PHS

3 mm | PROTECTIVE HARD SOLE





**BOOTS SIZE CHART**

SIZE DETAILS  
Pag 431

Ideal for outdoor sports and travel. They feature a Hard Sole that protects the feet against sharp rocks. Made with Super Elastic Neoprene for best comfort within the sole, it is built to provide extra comfort, and is also ultra-durable. The back of the heel has a special design that fits perfectly with open heel fins

for scuba diving. The small boot is used to prevent the slipping of the fins strap. A strong non-slip molding covers the entire sole. They are suitable for surfing, kayaking, scuba diving and different kind of water sports.

CODE	SIZE	CASE PACK
ULX443551	5	5
ULX443552	6,5	5
ULX443553	7,5	5
ULX443554	9	5
ULX443555	10	5
ULX443556	11	5
ULX443557	12	5
ULX443558	13,5	5



PACKAGING

# IBIZA

3 mm



## TECHNICAL FEATURES

- Super elastic neoprene for best comfort
- Vulcanize rubber sole
- Sole built to provide extra comfort
- Ultra durable



## BOOTS SIZE CHART

SIZE DETAILS  
Pag 431

The Ibiza 3 mm are lightweight boots ideal for outdoor sports and travel. Made with Super Elastic Neoprene for best comfort within the sole, it is built to provide extra comfort, and is also ultra durable. The back of the heel has a special design that fits

perfectly with open heel fins for scuba diving. The small boss is used to prevent the slipping of the fins strap. A strong non-slip molding covers the entire sole. They are suitable for surfing, kayaking, scuba diving and different kind of water sports.

CODE	SIZE	CASE PACK
US435500	5	20
US435501	6	20
US435502	7	20
US435503	8	20
US435504	9	20
US435505	10	20
US435506	11	20
US435507	12	20
US435508	13	20
US435509	14	20



POLYBAG

# MINORCA LONG

3 mm



## TECHNICAL FEATURES

- Super elastic neoprene for best comfort
- Vulcanize rubber sole
- Sole built to provide extra comfort
- Ultra durable



## BOOTS SIZE CHART

SIZE DETAILS  
Pag 431

CODE	SIZE	CASE PACK
US040000	5	10
US040001	6	10
US040002	7	10
US040003	8	10
US040004	9	10
US040005	10	10
US040006	11	10
US040007	12	10
US040008	13	10
US040009	14	10



POLYBAG

# MINORCA SHORT

3 mm



The Minorca Short 3mm are lightweight shoes ideal for outdoor sports and travel. Made with Super Elastic Neoprene for best comfort within the sole, it is built to provide extra comfort and is also ultra durable.

The sole is made of long-lasting rubber to avoid slipping on wet or smooth surfaces. They are suitable for surfing, kayaking, scuba diving and different kind of water sports.

CODE	SIZE	CASE PACK
USD42000	5	20
USD42001	6	20
USD42002	7	20
USD42003	8	20
USD42004	9	20
USD42005	10	20
USD42006	11	20
USD42007	12	20
USD42008	13	20
USD42009	14	20

**TECHNICAL FEATURES**

- Super elastic neoprene for best comfort
- Vulcanize rubber sole
- Sole built to provide extra comfort
- Ultra durable

**BOOTS SIZE CHART**

SIZE DETAILS  
Pag 431

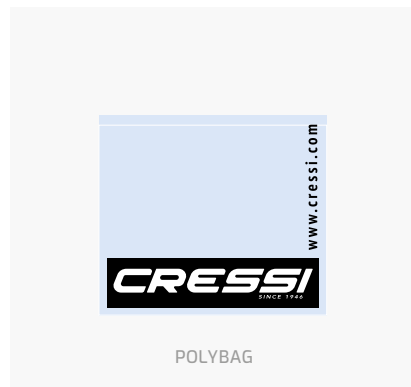

# SARAGO

THERMAL SOCKS | 7 mm - 5 mm



**SOCKS SIZE CHART**

SIZE DETAILS  
Pag 432

These socks for fins with strap or foot pocket are made of soft highly elastic nylon-lined neoprene. They prevent heat loss and keep feet warm. The smooth skin neoprene on the ankle allows maximum adherence

between the sock and the leg of the wetsuit, reducing the passage of water. The sole is entirely non-slip. The construction of the blind stitch seam further improves comfort and aesthetics.

7 mm

CODE	SIZE	CASE PACK
XLX440700	2XS	10
XLX440701	XS	10
XLX440702	S	10
XLX440703	M	10
XLX440704	L	10
XLX440705	XL	10
XLX440706	2XL	10

**NEW 2024** 5 mm

CODE	SIZE	CASE PACK
XLX440500	2XS	10
XLX440501	XS	10
XLX440502	S	10
XLX440503	M	10
XLX440504	L	10
XLX440505	XL	10
XLX440506	2XL	10



# CANARIE LT NEW 2024

## ERGONOMIC THERMAL SOCKS | 4 mm - 2 mm

Designed with left and right feet to fit every curve and bend with each foot movement. The Premium Ultra-stretch Neoprene will be your "second foot," lined with elastic nylon. Ideal for keeping your feet warm underwater and preventing any abrasion caused by extensive training, rocks, or jellyfish. These are the only soft-soled neoprene socks you'll ever need for Spearfishing, Freediving, Surfing, Canyoneering, Watercraft, or any water sports you want to practice.



### SOCKS SIZE CHART

SIZE DETAILS  
Pag 432

4 mm

CODE	SIZE
LX461452	S
LX461453	M
LX461454	L
LX461455	XL
LX461456	2XL

2 mm

CODE	SIZE
LX461252	S
LX461253	M
LX461254	L
LX461255	XL
LX461256	2XL

# CANARIE ST NEW 2024

## ERGONOMIC THERMAL SOCKS | 2 mm

The Canarie socks are designed with left and right feet to fit every curve and bend with each foot movement. The Premium Ultra-stretch Neoprene will be your "second foot," lined with elastic nylon. Ideal for keeping your feet warm under water and in preventing any abrasion caused by extensive training, rocks, or jellyfish. These are the only soft-soled neoprene socks you'll ever need for Spearfishing, Freediving, Surfing, Canyoneering, Watercraft, or any water sports you want to practice.



### SOCKS SIZE CHART

SIZE DETAILS  
Pag 432

CODE	SIZE
LX460252	S
LX460253	M
LX460254	L
LX460255	XL
LX460256	2XL

### TECHNICAL FEATURES

- Waterleg-seal. Keeps water out. Perfect adhesion and retains heat
- Blind and glued stitches. Improved durability and ad comfort
- Abrasion resistant toe guard. For Extra Protection and Prolonged life of the socks.
- Abrasion resistant strong bottom
- Ergonomic heel shaped pattern. Ideal design to avoid baggy fit

## PALMA LT

### ANTI-SLIP SOLE SOCKS | 3 mm

These tall socks are great for either full foot or open heel fins. The socks are lightweight and a great addition to the traveling diver's gear bag. Socks are extremely comfortable equipped with a Rubber Grip Sole design to assist with Non-Slip on wet surfaces such as boat decks and slippery ladders. The Palma are built-to-last with glued-and-sewn seams for strength and durability.



#### TECHNICAL FEATURES

- Grip design to assist with nonslip
- Super elastic neoprene for best comfort
- Ultra durable
- Lightweight, ideal for travel
- With Anti-slip sole



#### SOCKS SIZE CHART

SIZE DETAILS  
Pag 432

CODE	SIZE	CASE PACK
US036002	XS	5
US036003	S/M	5
US036004	M/L	5
US036005	L/XL	5
US036006	XL/2XL	5

## PALMA ST

### ANTI-SLIP SOL SOCKS | 3 mm

These short socks are great for either full foot or open heel fins. The socks are lightweight and a great addition to the traveling diver's gear bag. Socks are extremely comfortable equipped with a Rubber Grip Sole design to assist with Non-Slip on wet surfaces such as boat decks and slippery ladders.



#### TECHNICAL FEATURES

- Grip design to assist with nonslip
- Super elastic neoprene for best comfort
- Ultra durable
- Lightweight, ideal for travel
- With Anti-slip sole



#### SOCKS SIZE CHART

SIZE DETAILS  
Pag 432

CODE	SIZE	CASE PACK
US035002	XS	10
US035003	S/M	10
US035004	M/L	10
US035005	L/XL	10
US035006	XL/2XL	10

## ORATA

### SOFT SOLE SOCKS | 2.5 mm

These are single-lined, thin, high stretch neoprene socks. The inner is lined in Metallite so they are easy to put on. The sole has an effective non-slip lining. They can be used with both closed foot fins for greater warmth and to protect the skin from scratches and chafing, as well as with firm-soled socks, using open-heel fins. In this case, warmth is considerably increased and it is also easier to put on your wetsuit.



#### SOCKS SIZE CHART

SIZE DETAILS  
Pag 432

CODE	SIZE	CASE PACK
LX433001	S	10
LX433002	M	10
LX433003	L	10
LX433004	XL	10

# ULTRA STRETCH SOCKS

1.5 mm



## SOCKS SIZE CHART

SIZE DETAILS

Pag 432

Created in extremely supple, 1.5 mm thick, double-lined Ultraspan neoprene, these socks have non-slip and anti-wear soles and an Aquastop sealing single-lined neoprene at the top. They are perfect for all indoor and outdoor water sports thanks to the high protection and thermal function that they offer.



CODE	SIZE	COLOR
XDF200120	S	Blue
XDF200121	M	Blue
XDF200122	L	Blue
XDF200123	XL	Blue
XDF200150	S	Black
XDF200151	M	Black
XDF200152	L	Black
XDF200153	XL	Black

# FIN SOCKS

SPANDEX



## SOCKS SIZE CHART

SIZE DETAILS

Pag 432

Fin-socks are designed for people who live in their fins and need that perfect snug fit of a full foot fin. But also for people who seldom use fins or have sensitive feet. These socks are the solution that will allow you to wear your fins for hours without chafing your feet.



CODE	SIZE	COLOR
USW030000B	S/M	Blue
USW031000B	L/XL	Blue
USW030000K	S/M	Black
USW031000K	L/XL	Black
XLX412001	S/M	Aquamarine
XLX412002	L/XL	Aquamarine
XLX412701	S/M	Lilac
XLX412702	L/XL	Lilac





# BAGS & BACKPACKS

SCUBA

# JUMBO

600-DENIER TWISTED | POLYESTER FILAMENT | YKK ZIP



**140**  
LITERS

## TECHNICAL FEATURES

- PVC lamination
- Made of 600 Denier twisted polyester fabric
- Water-repellent coating
- YKK Zippers
- Adjustable shoulder straps for carrying as a backpack



TWO-POSITION TELESCOPIC HANDLE



ANATOMIC SHOULDER STRAPS



HIGHLY RESISTANT WHEELS

The Jumbo bag is designed for very demanding divers who want to transport all the equipment they need for their dives during their holiday travels or free time. The ample volume (140 liters) and internal partitioning makes luggage easy to prepare. The two side pockets, with the fin logo inside, can hold a pair of large fins, up to size XXL. The two front pockets are handy for packing accessories, like towels, t-shirts and sunglasses.

The top pocket protects the two-position telescopic handle and also conceals a special small pocket inside for a personal details card. The spacious inside compartment has room to organize all technical equipment up to size XXL (e.g. a complete

7 mm hooded wetsuit, jacket, boots, gloves, mask, mouthpiece, regulator, etc.), securing it with two special straps. The system of buckles on the outside allows the bag to be compacted further, by pulling on the straps according to how much is packed in it.

The large wheels are highly resistant and easily replaceable, as they are attached with screws and locknuts.

The shoulder straps can be easily concealed in the back pocket and pulled out when needed. The new adjustment buckles on the shoulder straps allow rapid adjustment, even with the bag on the back.

CODE	CASE PACK
UB932500	1

JUMBO	DIMENSION (LENGTH-WIDTH-HEIGHT)		VOLUME		WEIGHT	
	cm	in	liter	cu ft	kg	lb
	50 x 35 x 80	19 3/4 x 13 3/4 x 31 1/2	140	4.9	4.5 kg	9 lb 15 oz

# MOBY 7

NEW  
2024

WHEELED BAG & BACKPACK



**115**  
LITERS



DETACHABLE POCKET

Introducing the ultimate travel companion, the Moby 7. Made of durable 450D Ripstop fabric, this trolley offers superior strength and longevity, just like its renowned predecessor, the Moby 5. Front pockets, made of water-repellent material, offer convenient options for storing essentials. The trolley features heavy-duty PVC-coated mesh fabric on the top and bottom sides for exceptional durability. Equipped with heavy-duty wheels, this equipment transport system allows for effortless manoeuvrability. The YKK plastic zip ensures a smooth and reliable closure. For added convenience, a detachable lower pocket with a concealed hanging strap and thermoplastic side loops for attaching the shoulder strap is included. The inner, lined pocket securely holds the padded shoulder strap. In addition, the Moby 7 has a small front pocket with a semi-dry zip, perfect for storing valuables. As additional equipment, a folding mesh bag with drawstring closure is included, which can be conveniently stored in the small front pocket. The Moby 7 is the epitome of functionality, durability and style for the modern traveller.



DETACHABLE POCKET

CODE CASE PACK  
UB932700 1

MOBY 7	DIMENSION (LENGTH-WIDTH-HEIGHT)		VOLUME		WEIGHT	
	cm	in	liter	kg	lb	
	76 x 40 x 28	30 x 15.8 x 11	115	4.9 kg	10.8	





# MOBY 5 HYDRO & MOBY 5

## LARGE WHEELED LUGGAGE



**MOBY 5**

**MOBY 5 HYDRO**

Large wheeled luggage ideal to carry scuba diving equipment and other water activity gear. Made of 300 and 400 Denier fabric that is light and very strong with a good looking waterproof coating. The main compartment opens on three sides allowing easy access. There are two large bellows pockets in the front with zip closures, two side pockets for fins and a small upper pocket that holds an address tag. There are also two adjustable, padded, straps for carrying on the back that can be placed in special pockets when the backpack is being wheeled. The reinforced pull handle is telescopic and fully retractable. The wheels have a large diameter and can be removed and easily replaced in the event of breakage. There are two carrying handles: a reinforced one at the top and one with Velcro closure at the bottom. The back of the bag houses supporting rods to keep the bag in a vertical position. All the zips are very strong YKK.

### TECHNICAL FEATURES

- Made of 300 and 400 Denier fabric with waterproof coating
- 2 large bellows pockets
- 2 long side pockets that can hold a pair of fins

#### WIDE FRONT POCKET



ADJUSTABLE SHOULDER

#### YKK ZIPPER



#### HEAVY-DUTY WHEELS



2024 - CATALOG

**115**  
LITERS

CODE	PRODUCT	CASE PACK
UB932200	MOBY 5	1
XUB932256	MOBY 5 HYDRO	1

MOBY	DIMENSION (LENGTH-WIDTH-HEIGHT)		VOLUME		WEIGHT	
	cm	in	liter	cu ft	kg	lb
<b>5</b>	53 x 40 x 76 h	15 1/2 x 11 x 30 h	115	4.06	3.9 kg	8 lb 10 oz
<b>5 hydro</b>	53 x 40 x 76 h	15 1/2 x 11 x 30 h	115	4.06	5.1 kg	11 lb 4 oz

<b>MAIN COMPARTMENT</b>	40 x 28 x 75 cm 15 3/4 x 11 x 29 1/2 in
<b>UPPER FRONT POCKET</b>	30 x 7 x 24 cm 11 3/4 x 2 3/4 x 9 1/2 in
<b>LOWER FRONT POCKET</b>	31 x 7 x 37 cm 31 1/4 x 2 3/4 x 14 1/2 in
<b>FIN POCKET</b>	22 x 6 x 69 cm 8 1/2 x 2 1/2 x 27 in

CRESSI

# MOBY 3 NEW 2024

ROBUST AND SPACIOUS WHEELED BAG



**100**  
LITERS



Introducing the Moby 3, the little brother of the trolley you know and love. Made of a state-of-the-art 300/400 denier material, this trolley combines a light and attractive design with exceptional durability. The spacious main compartment opens on three sides, providing easy access to your personal belongings. Thanks to the two large side pockets specially designed for fins, you will have ample space to store your belongings. For comfortable transport, the Moby 3 is equipped with large-diameter wheels, which can be easily changed if necessary. The trolley has reinforced carrying handles at the top and bottom. Like its predecessor, the Moby 3 is equipped with robust YKK zips that guarantee durability. Enhance your travelling experience with the Moby 3.

CODE	CASE PACK
UB932600	1

MOBY 3	DIMENSION (LENGTH-WIDTH-HEIGHT)		VOLUME	WEIGHT	
	cm	in	liter	kg	lb
	76 x 40 x 28	30 x 15.8 x 11	100	4.5 kg	9.9

# MOBY LIGHT NEW 2024



**85**  
LITERS



Large wheeled luggage ideal to carry scuba diving equipment and other water activity gear. Made of 300 and 400 Denier fabric that is light and very strong with a good looking. The main compartment opens on one side allowing easy access.

The reinforced pull handle is telescopic and fully retractable. The wheels have a large diameter and can be removed and easily replaced in the event of breakage. All the zips are very strong YKK.

CODE	CASE PACK
UB932300	1

MOBY LIGHT	DIMENSION (LENGTH-WIDTH-HEIGHT)		VOLUME	WEIGHT	
	cm	in	liter	kg	lb
	42 x 26 x 73	16.5 x 10.5 x 29	85	2.9	6.4

## TECHNICAL FEATURES

- Made of 300 and 400 Denier
- Easy acces to interior
- ykk zippers
- Heavy-Duty Wheels





# PIPER

ULTRALIGHT TROLLEY | 2.9 KG



**49**  
LITERS



The Piper is a suitcase designed and especially convenient for air travel, with a special 2 stage telescopic handle and 2 exterior compression straps with quick-release buckles. Several zippers, heavy-duty wheel housing, bumper protection, and scratch resistant denier fabric ensure that your equipment will be able to be stored safely. Grab handles on the top, side, and bottom of the suitcase make this very easy to hold.

The interior of the Piper features compression straps and a side pocket to help organize your belongings. A back ID pocket makes it possible to label your suitcase. At 2.9 kg | 6.4 lb and 4.9 liters | 1.73 cubic feet of capacity, the Piper is light and great for traveling. Its dimensions are compliance with the carry-on airplane regulations: 35.5 x 23 x 56 cm | 14 x 9 x 22 in.

## TECHNICAL FEATURES

- Book-style opening
- 2-stage telescopic handle
- 2 exterior compression straps with quick-release buckles
- Top pocket with zipper
- Central lock point zipper for pickpocket protection
- Heavy-duty wheel housing and bumper protection
- Grab handles on top, side and bottom for easy grab-and-go
- Interior compression straps and side pocket for organization
- Internal mesh compartment with zipper
- Robust wheels for multi-terrain maneuverability
- Back ID pocket
- Scratch-resistant Denier fabric
- Only 6 lb weight
- Front-zip for easy donning and doffing



TELESCOPIC HANDLE



ROBUST WHEELS FOR MULTI-TERRAIN MANEUVERABILITY



**MALPELO  
+  
PIPER**

CODE	CASE PACK
UB952000	2

PIPER	DIMENSION (LENGTH-WIDTH-HEIGHT)		VOLUME		WEIGHT	
	cm	in	liter	cu ft	kg	lb
	35,5 x 23 x 56	14 x 9 x 22	49	1.73	2.9 kg	6 lb 6 oz

# MALPELO

NEW 2024

## ADVANCED FEATURES BACKPACK



**40**  
LITERS



TROLLEY HANDLE  
ATTACHMENT STRAP

40-liter backpack designed by the Cressi team. It has a double-zip "U" shaped front pocket with a padded compartment for a tablet or large (17") laptop. Interior zippered mesh compartments provide additional organization. Also included is a vertical-zippered front-facing pocket for any documents that need extra protection. Small loops stitched to the exterior outer edge can be used to latch lighter gear. A zippered elastic side-pockets makes accessing small items easy. There are two carrying handles, one on the top and one on the side, to make carrying easy and comfortable. There are also two shoulder straps, making it possible to wear as a backpack. The straps are padded to provide comfort and reduce stress on the shoulders and back. The bag features a fully adjustable/removable sternum strap to help support the load while being worn as a backpack.

CODE CASE PACK  
UB938000 2

MALPELO	DIMENSION (LENGTH-WIDTH-HEIGHT)		VOLUME		WEIGHT	
	cm	in	liter	kg	lb	
	42 x 13 x 61	17 x 5 x 41	40	1.3	2.86 lb 48 oz	

### TECHNICAL FEATURES

- Double slider front zipper
- Laptop compartment
- Adjustable padded straps
- Frontal pocket with zip



**MALPELO  
+  
PIPER**

# MEGATTERA

DRY DIVING BAG  
WITH SPECIAL FINS COMPARTMENT



**110**  
LITERS

## TECHNICAL FEATURES

- Made of 500 D Tarpaulin
- Diving equipment pockets
- Waterproof internal compartment
- Volume: 110 liters
- Dimensions: 83 x 41 x 34 cm | 32.7 x 16.2 x 13.4 in
- Weight: 2,10 kg | 4.63 lb



Megattera is a diving bag to carry all your equipment and accessories. It's equipped with handles and adjustable shoulder strap. Megattera is strong and capacious. It is made of 500 denier tarpaulin, while for the bottom the same material has been used but with an anti-abrasion treatment. Equipped with a practical upper zipper to easily insert all the accessories and diving equipment, Megattera has two pockets designed especially for divers. The first is external and closed with a buckle, perfect for carrying diving fins; the second pocket is a waterproof internal compartment for carrying equipment and wet clothes.



CODE	CASE PACK
XUA926150	5

MEGATTERA	DIMENSION (LENGTH-WIDTH-HEIGHT)		VOLUME		WEIGHT	
	cm	in	liter	kg	lb	
	83 x 41 x 34	32.7 x 16.2 x 13.4	110	2,10 kg	4.62	



# TUNA DRY

WHEELED BAG - FITS LONG BLADE FIN



### TECHNICAL FEATURES

- Waterproof bag
- Made of Polyester
- External pocket
- Side handles and shoulder straps



2024 - CATALOG

**120**  
LITERS



BLACK/RED



BLACK/BLUE

The Tuna Dry Wheel Bag is an ideal bag for transporting any kind of equipment for water activities keeping protected from water. It has a capacity of 120 liters | 4.23 cu ft that can fit also long freediving fins. Made of highly resistant materials, it allows you to keep your equipment dry and protect electronic devices. Equipped with central handles/ shoulder straps and side handles to facilitate transport even with the presence of wheels. The presence of wheels facilitates transport even on long routes. Equipped with practical central handles/ shoulder straps and reinforced side handles.

A practical waterproof side pocket keeps small items dry and protects electronic devices. Internal straps with clip closure allow you to secure the sports equipment during transport. Made of very resistant materials, with well-finished stitching. The lower part is reinforced, shockproof and insulating. Waterproof seal. Keep your equipment dry, protect electronic devices and documents from water, dust, and sand.

CODE	COLOR	CASE PACK
XUB976200	Black/Red	2
XUB976220	Black/Blue	2

TUNA	DIMENSION (LENGTH-WIDTH-HEIGHT)		VOLUME		WEIGHT	
	cm	in	liter	cu ft	kg	lb
	40 x 41 x 95	37 1/2 x 15 3/4 x 16 1/8	120	4.23	3.5 kg	7 lb 11 oz

CRESSI

# SPIDY

## DRY DECKCASE PACK 25 LITER



**25**  
LITERS

Spidy 25L Dry Deckcase pack born from the desire to create a waterproof backcase pack that can be comfortably carried on water during paddling activities. Spidy deckcase pack features adjustable straps with snap hooks, which can be hooked to the D-rings of each SUP boards from our collection.

The backcase pack is completely waterproof and can be opened and closed in two different ways: from the top side, thanks to the large opening with strap for watertight closure, or from the bottom by the practical dry zip that surrounds the backcase pack's

structure. The lower hinged opening is especially useful during paddling, when the Spidy is fastened at the board, as it lets you easily access the inside of the deckcase pack without having to unroll the upper opening. The front of the backcase pack has a bungee rope to storage equipment, while the side has a utility pocket.

The back and the adjustable padded shoulder straps, combined with the chest strap, make the Spidy a practical, comfortable and roomy backcase pack, ideal for all water activities.

### TECHNICAL FEATURES

- Dry backcase pack
- Rolltop closure + Dry zip bottom
- Sturdy polyester coated PVC fabric
- Seamless stitching technology
- Padded shoulder straps
- 25 L capacity
- External mesh pocket
- Front Bungee cord
- Snap hooks for D-Rings fastening

Box dimensions:  
50 x 7 x 45 cm | 23.5 x 2.8 x 17.7 in

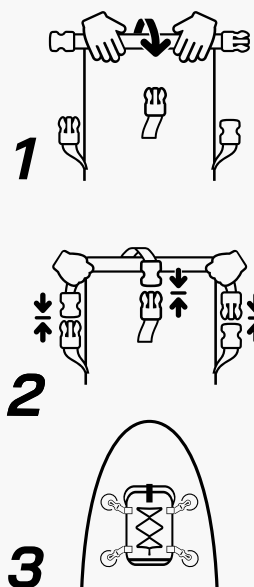

CODE	CASE PACK
NW022550	6



# DRY BAG PREMIUM



BLACK / BLUE

It is a waterproof 20 liters bag made of high-quality PVC. Perfect for scuba diving, fishing, sailing, water sports, and outdoor activities. Fitted with handy removable shoulder straps for wearing the bag like a backpack and a reinforced side handle to make it easy to carry. Practical and lightweight, it was made to protect your necessary items from the water.



## TECHNICAL FEATURES

- 20 liters | 0.70 cu ft of capacity
- Waterproof PVC coating
- Adjustable shoulder straps
- Rolling waterproof closure with buckle
- Front watertight zipped pocket
- Lateral reinforced handle

**20**  
LITERS



BLACK / RED



BLACK / YELLOW



BLACK / BLACK

CODE	COLOR	SIZE	CASE PACK
XUA962010	Black/Yellow	20 liters	10
XUA962020	Black/Blue	20 liters	10
XUA962050	Black/Black	20 liters	10
XUA962058	Black/Red	20 liters	10

# DRY TEK BAG



**20**  
LITERS



**10**  
LITERS

## TECHNICAL FEATURES

- Shoulder strap carabiner fastens to the loop
- Made of durable PVC
- Hermetic seams
- Handy closure
- Adjustable, removable shoulder straps



The Dry Tek Bag is a waterproof bag that's great for protecting items and clothing from sand, soil, water, and snow. To close it, roll it down from the top and fasten the buckle. It is very easy to transport using

the handy shoulder strap. Ideal for carrying your suit, fins, and mask, even when they're wet. Warning: This product should not be submerged.



CODE	COLOR	SIZE	CASE PACK
XUA955010	Black	10 liters	10
XUA955020	Black	20 liters	10



# DRY BAG



## FINESTRA DRY BAG

## DRY BAGS

**20**  
LITERS

**20**  
LITERS

**10**  
LITERS



### TECHNICAL FEATURES

- Made in waterproof fabrics with electric resistance welding
- 10L and 15L version: one adjustable shoulder strap
- 20L: robust side handle and back pack
- Shoulder straps

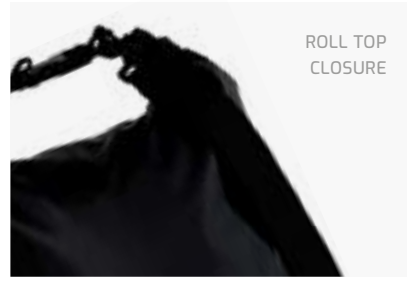

ROLL TOP CLOSURE

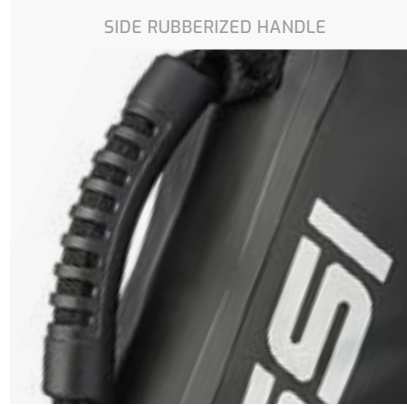

SIDE RUBBERIZED HANDLE



ADJUSTABLE SHOULDER STRAP

The Dry Bags are designed for boating and water sports. They're made in high quality resistant soft touch material. It is possible to easily pack inside another bag for transport. Bags have electronically (RF) welded seams that make the bag 100% waterproof. This proven design provides all-purpose,

reliable protection for your gear. Bags have a roll top closure with a squeeze-style side-release buckle. When buckle is fastened, the roll top provides a carry handle for easy transport. Bags are also equipped with easily adjustable shoulder straps.

CODE	COLOR	SIZE	CASE PACK
UA955010	Black/Finestra	10 liters	10
UA935710	Black/Silver	10 liters	10
UA935720	Black/Silver	20 liters	10

	DIMENSION (LENGTH-WIDTH-HEIGHT)		VOLUME			WEIGHT	
	cm	in	liter	cu ft	kg	lb	
DRY BAG 20L	Ø 23 x 43	Ø 9 x 17	20	0.71	480 g	16.9 oz	
DRY BAG 15L	Ø 23 x 34	Ø 9 x 13 1/2	15	0.53	350 g	12.3 oz	
DRY BAG 10L	Ø 19 x 36	Ø 7 1/2 x 14 1/8	10	0.35	320 g	11.3 oz	
DRY BAG 5L	Ø 19 x 28	Ø 7 1/2 x 11	5	0.18	255 g	9 oz	

### SYSTEM ROLL TOP CLOSER



1

2

3

4

# ROATAN

600 DENIER

2024 - CATALOG



**90**  
LITERS

The Roatan mesh liter bag is perfect to keep all your scuba gear together. Made with high-density polyester, this mesh bag makes carrying your gear easy. The bag is equipped with two access points - a drawstring on the top and a full-length zipper on the side - to make retrieving equipment easy, even if wet.

The bag can be worn like a backpack, with padded, adjustable shoulder straps and chest strap. It can

also be carried with two reinforced handles, one on the side and one on the top.

Included is a semi-dry front pocket with a zipper closure. A drain in the reinforced PVC bottom ensures that any water empties out, making this a perfect option to rinse your gear after use.

## TECHNICAL FEATURES

- Front semi-dry pocket with zipper closing
- Anatomical adjustable shoulder straps and chest strap
- Reinforced top and side handles
- Top closure: drawstring closing with fastener
- Side Closure: full-length, double-enforced zipper
- Drain on bottom of the bag
- Materials: 600 Denier - High Density Polyester and 4 needle PVC mesh
- Height: 28.5 in with a diameter of 16 in
- Capacity: 3.18 cu ft | 90 liters

SEMI DRY- FRONT POCKET

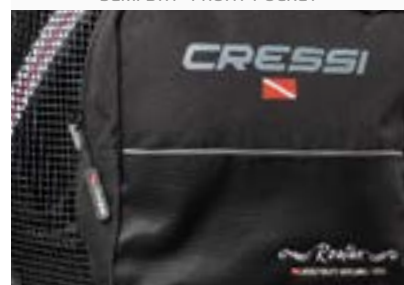

PADDED, ADJUSTABLE SHOULDER STRAPS



DRAWSTRING ON THE TOP

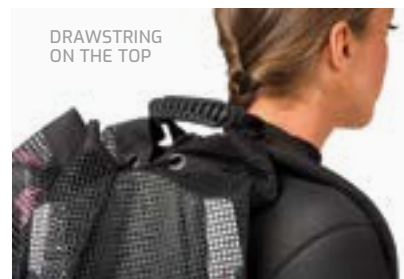

CHEST STRAP



CODE	CASE PACK	DEALER	ASSOCIATE	MASTER	PARTNER	MAP
UB936000	10	52.88	50.24	47.59	44.95	89.95

ROATAN	DIMENSION (LENGTH-WIDTH-HEIGHT)		VOLUME		WEIGHT	
	cm	in	liter	cu ft	kg	lb
	ø 39.5 - 72	ø 15 - 28	90	3.18	1.2 kg	2 lb 10 oz

CRESSI

# UTILA

1680 DENIERG



**85**  
LITERS

The Utila mesh liter bag is perfect for water sports lovers on the go. Made with high-density polyester, this wire mesh bag makes carrying your gear easy. The bag is equipped with a drawstring on the top to make retrieving equipment easy, even if wet. The bag can be worn like a backpack, with padded, adjustable shoulder straps and chest strap.

The Utila folds up into a small, compact case with a padded carrying handle for easy packing and transportation.

Included is a front semi-dry pocket with a zipper closure, shoulder straps.

## TECHNICAL FEATURES

- Lightweight mesh backpack
- Front semi-dry pocket with zipper closing
- Easily foldable into itself for storage
- Anatomical adjustable shoulder straps
- Top closure: drawstring closing with fastener
- Side Closure: double-enforced zipper
- Soft-padded handle included for carrying
- Air vent hole in the bottom to facilitate drying
- Materials: 1680 Denier - High Density Polyester and Hexagonal wire mesh
- Height: 29 in with a diameter of 15.5 in
- Capacity: 3 cu ft | 85 liters

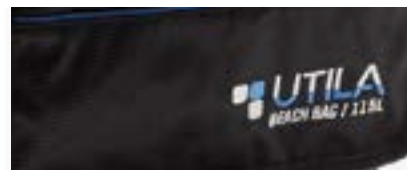

BACK VIEW



PADDED, ADJUSTABLE SHOULDER STRAPS

CODE	CASE PACK	DEALER	ASSOCIATE	MASTER	PARTNER	MAP
UB937000	20	37.06	35.21	33.35	31.50	59.95

UTILA	DIMENSION (LENGTH-WIDTH-HEIGHT)		VOLUME		WEIGHT	
	cm	in	liter	cu ft	kg	lb
	ø 38.5 - 70	ø 15 - 27	85	3.00	1.1 kg	2 lb 7 oz



# GORGONA

## TRAVEL MESH BAG

**107**  
LITERS



The Cressi Gorgona is great for hauling virtually any dive equipment, even the heavy stuff. The duffel-style mesh bag is made of durable 70% polyester mesh and 30% 600-D polyester PUX2 material that lets water drain easily. Roomy enough and strong enough for a full set of gear, it is an ideal gear-hauler for live-aboard use or for carrying dive suits separately. The mesh bag is also excellent for carrying rental equipment when resort diving. It folds compactly into a round bag with handle and is easy to store in your suitcase or main

dive bag, ready when you need it. Bag is equipped with YKK zippers. Padded full wrap-around carry handles make hefting the load that much easier. The great thing about a mesh bag is that when you get to the wash tank on the dock after a day-of-diving you can submerge the entire bag in the tank and rinse your gear while still-in-the-bag. You can then let the gear drip-dry on the way home or back in the hotel shower when on vacation. The Gorgona dimensions are long enough to pack even the longest freediving fins.

### TECHNICAL FEATURES

- Travel mesh bag practical to carry or rinse the equipment
- The length is sized to house even the longest freediving fins
- Bag easily foldable for becoming a practical round bag with handle
- Fabric: 70% polyester mesh, 30% 600D polyester PUX2

CODE	CASE PACK	DEALER	ASSOCIATE	MASTER	PARTNER	MAP
UA925900	5	35.24	33.48	31.72	29.95	54.95

GORGONA	DIMENSION (LENGTH-WIDTH-HEIGHT)		VOLUME		WEIGHT	
	cm	in	liter	cu ft	kg	lb
	ø 38x96	ø 15x 37 3/8	107	3.78	750 g	1 lb 10 oz



# CRETE

## TRAVEL MESH BAG

Travel mesh bag practical to carry or rinse the equipment



**64,5**  
LITERS

CODE	COLOR	CASE PACK	DEALER	ASSOCIATE	MASTER	PARTNER	MAP
UA929110	Yellow	5	29.35	27.88	26.42	24.95	44.95
UA929120	Blue	5	29.35	27.88	26.42	24.95	44.95

CRETE	DIMENSION (LENGTH-WIDTH-HEIGHT)		VOLUME		WEIGHT	
	cm	in	liter	kg	lb	
	37 x 37 x 67	37 x 37 x 67	64,5	0,57	1,25 lbs	

# EQUIPMENT BAGS

## NET BAG



**DIMENSIONS:**  
Height: 75 cm, 29.5 in Width: 27.5 cm, 10.8 in

The Net Bag with drawstring closure with barrel lock fastener is ideal for carrying long fins and snorkeling equipment. The net style mesh allows to rinse the fins while still in the bag and hang to drip dry after use.

CODE	CASE PACK	DEALER	ASSOCIATE	MASTER	PARTNER	SP
BZ175003	5	4.65	4.42	4.19	3.95	6.95

## COMBO BAG



**DIMENSIONS:**  
Height: 51.2 cm, 20.2 in Width: 24.1 cm, 9.5 in

The Combo Bag has a nice design and features a durable plastic front to see the content. Velcro closing and handle for easy carrying.

CODE	DEALER	ASSOCIATE	MASTER	PARTNER	SP
US450032	4.41	4.19	3.97	3.75	7.50



## CRESSI FREEDIVING 2024 COLLECTION

The range of blues that will be used to reflect the brand personality of Cressi's Freediving line go from a calming teal to a meditative inky-blue. Only freedivers know the feeling of testing their limits – to push their body to explore underwater by using only their breath and the equipment that helps ensure their safety – Cressi's Freediving products are ones that freedivers can trust with confidence. From low-profile masks to easy-breathing snorkels to high-performance fins, Cressi's freediving products offer freedivers the opportunity to experience freedom, adventure, community, self-expression, mindfulness and personal challenge.





**FREEDIVING**



**EXPERIENCE  
YOUR FREEDOM**

# KING

## FREEDIVING COMPUTER WATCH



King is an extremely compact watch-computer specific for freediving, for beginners to masters. This innovative product boasts an algorithm developed in Cressi, which protects the freediver from the risk of Taravana and a function that avoids the risk of pulmonary edema. Mineral glass, a heavy-duty case with steel buttons for resistance to water pressure up to 120 m / 393 ft. Elegant metal bezel in AISI 316 steel with surface treatment, and ink-filled technology for the inscription. Silicone and polyamide wristband (to prevent tears and breakage) with a stainless steel buckle.

### TECHNICAL FEATURES

- High contrast display with extra large numbers
  - User-friendly menu
  - 12/24 hours time format and calendar
  - Dual-time option
  - Precision stopwatch
  - Alarm clock
  - Backlit display
  - Tide indicator
  - Choice of units in the metric or imperial system
  - Sleep mode to increase battery life
  - Low battery indicator
  - User-replaceable battery: CR2450 3V
- FREE MODE**
- Taravana risk reduction algorithm with 8 levels
  - Pulmonary edema risk reduction function with approach dive calculation
  - Display of all diving parameters
  - Depth
  - Temperature
  - Dip counter
  - Maximum dive depth
  - Dive time
  - Length of the surface interval between each dive
  - Length of diving session
  - Maximum descent and ascent speed indication
  - Depth, dive time, and surface interval alarms
  - Recovery time alarm
  - Hydration alarm
  - Alarms that can be set at the dive phase
  - Fresh/salt water setting
  - Lock mode for snorkeling or swimming activities
- LOGBOOK**
- Variable data logging interval
  - Available during the diving session
  - Visualization of the dive sessions data
- INTERFACE**
- Software with visualization of the diving sessions (sold separately)

2024\_CATALOG



TARAVANA PROTECTION ALGORITHM



BLOODSHIFT PROTECTION ALGORITHM



TIDE LEVEL INDICATOR



SINGLE DIP LOGBOOK



CODE	COLOR	CASE PACK
K5842020	Blue	4
K5842050	Black	4
K5842085	Orange	4

### OPTIONAL ACCESSORIES

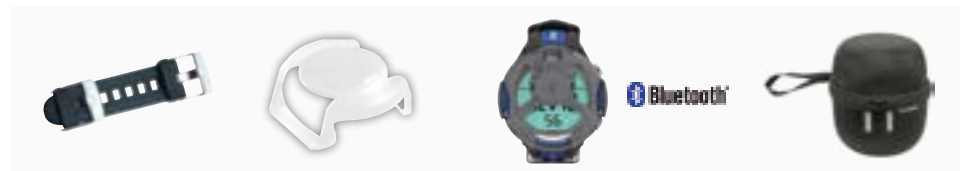

SILICONE PROTECTIVE LENS INCLUDED

#### ACCESSORIES

CODE	PRODUCT
KZ810000	STRAP EXTENDER for DIVE-WATCH COMPUTER - Black/Black
K5890000	SILICONE SCREEN PROTECTOR for DIVE WATCH
K5822001	BT INTERFACE for DIVE-WATCH COMPUTER
KZ700000	ELITE PROTECTIVE CASE for DIVE COMPUTER

#### SPARE PARTS

CODE	PRODUCT
KZ842020	SILICONE WATCHBAND - BLUE for DIVE-WATCH COMPUTER
KZ842085	SILICONE WATCHBAND - ORANGE for DIVE-WATCH COMPUTER
KZ805099	SCREWS w/ NUT (1 pair) for DIVE WATCH COMPUTER BAND
KZ901000	O-RING + SCREWS FOR WATCH-STYLE COMPUTER (no battery)

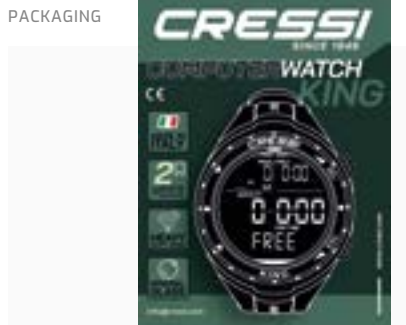

PACKAGING

CRESSI

# NEPTO

## FREEDIVING WATCH COMPUTER



Nepto is an extremely compact watch-computer specific for freediving. This innovative product boasts an algorithm developed in Cressi, which protects the freediver from the risk of Taravana and a function that avoids the risk of pulmonary edema. Mineral glass, the heavy-duty case with steel buttons for resistance to water pressure up to 120 m | 393 ft, rubber strap with stainless steel buckle.

### TECHNICAL FEATURES

- High contrast display with extra large numbers
- User-friendly menu
- 12/24 hours time format and calendar
- Dual-time option
- Precision stopwatch
- Alarm clock
- Backlit display
- Tide indicator
- Choice of units in the metric or imperial system
- Sleep mode to increase battery life
- Low battery indicator
- User-replaceable battery: CR2450 3V

#### FREE MODE

- Taravana risk reduction algorithm with 8 levels
- Pulmonary edema risk reduction function with approach dive calculation
- Display of all diving parameters
- Depth
- Temperature
- Dip counter
- Maximum dive depth
- Dive time
- Length of the surface interval between each dive
- Length of diving session
- Maximum descent and ascent speed indication
- 5-Depth, dive time, and surface interval alarms
- Recovery time alarm
- Hydration alarm
- Alarms that can be set at the dive phase
- Fresh/salt water setting
- Lock mode for snorkeling or swimming activities

#### LOGBOOK

- Variable data logging interval
- Available during the diving session
- Visualization of the dive sessions data

#### INTERFACE

- Software with visualization of the diving sessions (sold separately)



TARAVANA PROTECTION ALGORITHM



BLOODSHIFT PROTECTION ALGORITHM



TIDE LEVEL INDICATOR



SINGLE DIP LOGBOOK

CODE	COLOR	CASE PACK
K5841020	Blue	4
K5841050	Black	4
K5841098	Green	4

### OPTIONAL ACCESSORIES

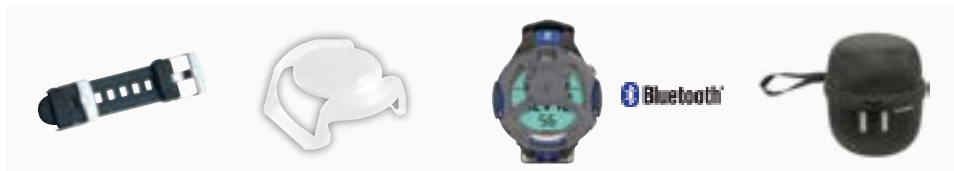

#### ACCESSORIES

CODE	PRODUCT
KZ810000	STRAP EXTENDER for DIVE-WATCH COMPUTER - Black/Black
K5890000	SILICONE SCREEN PROTECTOR for DIVE WATCH
K5822001	BT INTERFACE for DIVE-WATCH COMPUTER
KZ700000	ELITE PROTECTIVE CASE for DIVE COMPUTER

#### SPARE PARTS

CODE	PRODUCT
KZ901000	O-RING + SCREWS FOR WATCH-STYLE COMPUTER (no battery)

#### PACKAGING







**FINS**  
FREEDIVING





# GARA MODULAR IMPULSE

29 DEGREE ANGLED INTERCHANGEABLE BLADE



BLUE METAL    BLACK

**TECHNICAL FEATURES**

- Interchangeable blade
- Superior performance
- Superior comfort
- Self adjusting foot pocket
- Thermoplastic rubber footpocket, certified Full Contact
- Standard blade / stringer interface with screws under the footpocket and side clips

- LIGHTER
- SOFTER
- 100% PROPULSIVE PERFORMANCE
- MORE EFFICIENCY
- LESS EFFORT

The Gara Modular system introduced by Cressi makes this a perfect choice for deep freediving and spearfishing for divers of all levels. The modular design lets the user replace / interchange blades for specific diving purposes, which make this the perfect fin to grow with, as the diver can change blades as their skills increase. Any standard Fiberglass or Carbon Fiber long blade will interchange in minutes without any modifications to either.

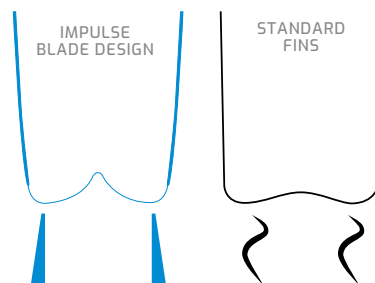
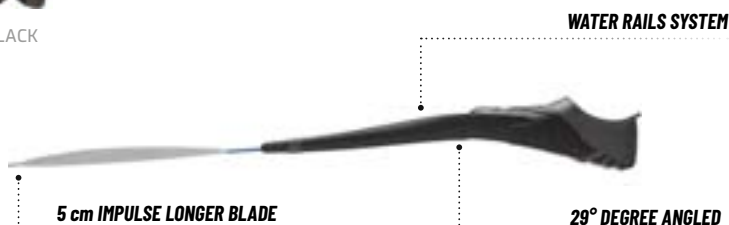

CODE	COLOR	SIZE	CASE PACK
BH092036	Blue	36/37	3
BH092038	Blue	38/39	3
BH092040	Blue	40/41	3
BH092042	Blue	42/43	3
BH092044	Blue	44/45	3
BH092046	Blue	46/47	3
BH095036	Black	36/37	3
BH095038	Black	38/39	3
BH095040	Black	40/41	3
BH095042	Black	42/43	3
BH095044	Black	44/45	3
BH095046	Black	46/47	3

ACCESSORIES

CODE	PRODUCT
BZ175032	RUBBER FIN KEEPER (PAIR) - BLACK (S)
BZ175033	RUBBER FIN KEEPER (PAIR) - BLACK (M)
BZ175034	RUBBER FIN KEEPER (PAIR) - BLACK (L)
BZ180022	INSOLE FOR GARA FINS

SPARE PARTS

CODE	PRODUCT
BZ180020	GARA MODULAR ASSEMBLY KIT
BH015036	GARA MODULAR TURBO FOOT POCKET (36/37)
BH015038	GARA MODULAR TURBO FOOT POCKET (38/39)
BH015040	GARA MODULAR TURBO FOOT POCKET (40/41)
BH015042	GARA MODULAR TURBO FOOT POCKET (42/43)
BH015044	GARA MODULAR TURBO FOOT POCKET (44/45)
BH015046	GARA MODULAR TURBO FOOT POCKET (46/47)

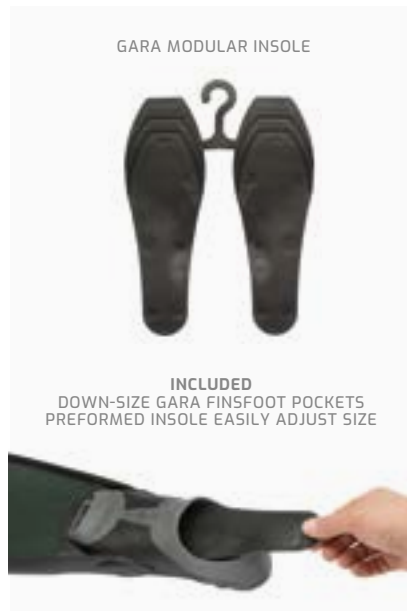

# GARA MODULAR IMPULSE TURBO

NEW COLOR  
2024

HIGH PERFORMANCE COMPACT FIN RAILS



NEW

WHITE

BLUE

BLACK

Following the Impulse project we have successfully transferred the same design parameters for S-shaped undulating deformation to this innovative fin. This particular movement permits a notable accumulation of elastic potential energy in the blade, which is released in the return kick, transforming into thrust.

The thermoplastic rubber used for the water channelling rails is extremely flexible and soft so as not to undermine the intrinsic characteristics of the blade.

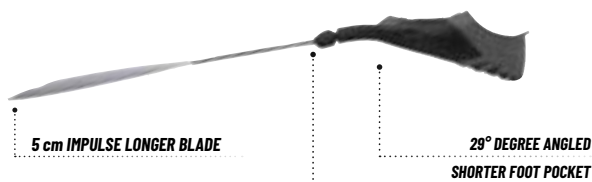

5 cm IMPULSE LONGER BLADE

29° DEGREE ANGLED  
SHORTER FOOT POCKET

## TECHNICAL FEATURES

- Extremely thin and light blade in compound made of elastomerized technopolymers developed by Cressi
- Stringer consisting of technopolymers with elastomeric loads with high flexural modulus
- Footpocket / blade angle of 29 degrees
- Modular detachable fin
- Superior performance
- Superior comfort
- Self adjusting foot pocket



GARA TURBO  
FOOT POCKET

## INCLUDED GARA MODULAR INSOLE

- The new insole for Gara Modular fins is recommended for use with thin boots in temperate waters, because it improves the kick performance. The semi-rigid material of the insole is completely recycled. The insoles are supplied as a pair (right and left foot) and can be cut into their shape in three different sizes, according to pre-printed guidelines.
- Down-size Gara Fins foot pocket preformed sole
- Easily adjust size
- Non-corrosive plastic construction



CODE	COLOR	SIZE
BH152036	Blue	36/37
BH152038	Blue	38/39
BH152040	Blue	40/41
BH152042	Blue	42/43
BH152044	Blue	44/45
BH152046	Blue	46/47
<b>NEW</b> BH153036	White	36/37
<b>NEW</b> BH153038	White	38/39
<b>NEW</b> BH153040	White	40/41
<b>NEW</b> BH153042	White	42/43
<b>NEW</b> BH153044	White	44/45
BH153046	White	46/47
BH155036	Black	36/37
BH155038	Black	38/39
BH155040	Black	40/41
BH155042	Black	42/43
BH155044	Black	44/45
BH155046	Black	46/47

WATER RAILS SYSTEM

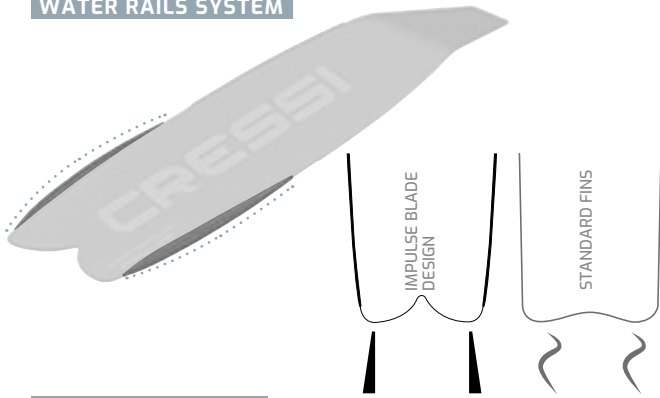

29° DEGREE ANGLED

- | LIGHTER | 100% PROPULSIVE PERFORMANCE
- | SOFTER | MORE EFFICIENCY, LESS EFFORT

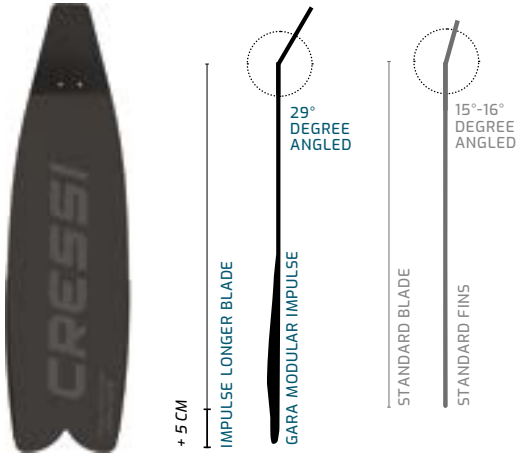

ACCESSORIES

CODE	PRODUCT
BZ175032	RUBBER FIN KEEPER (PAIR) - BLACK (S)
BZ175033	RUBBER FIN KEEPER (PAIR) - BLACK (M)
BZ175034	RUBBER FIN KEEPER (PAIR) - BLACK (L)
BZ180022	INSOLE FOR GARA FINs

SPARE PARTS

CODE	PRODUCT
BZ180020	GARA MODULAR ASSEMBLY KIT
BH015036	GARA MODULAR TURBO FOOT POCKET (36/37)
BH015038	GARA MODULAR TURBO FOOT POCKET (38/39)
BH015040	GARA MODULAR TURBO FOOT POCKET (40/41)
BH015042	GARA MODULAR TURBO FOOT POCKET (42/43)
BH015044	GARA MODULAR TURBO FOOT POCKET (44/45)
BH015046	GARA MODULAR TURBO FOOT POCKET (46/47)

FIT SIZE



To maximize performance and comfort, wear fins with:

<input checked="" type="checkbox"/>	<input checked="" type="checkbox"/>	<input type="checkbox"/>	<input type="checkbox"/>
BARE FOOT	NEOPRENE SOCKS	NEOPRENE BOOTS 3 mm 5 mm 7 mm	HARD SOLE BOOTS 3 mm 5 mm 7 mm

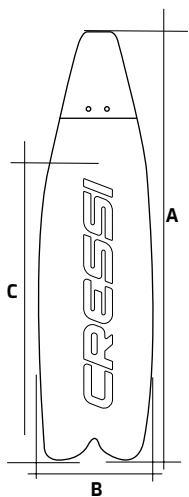

FIN SIZE	PRODUCT DIMENSION CHART			FIN HEIGHT FIT	SINGLE FIN WEIGHT	SIZE CONVERSION CHART			
	A LENGTH	B WIDTH	C BLADE			EU FOOT SIZE	UK FOOT SIZE	US MEN'S FOOT SIZE	US WOMEN'S FOOT SIZE
36/37	671 mm	215 mm	430 mm	83 mm	831 g	36 / 37	3 / 4	4 / 5	5 / 6
	26.4 in	8.5 in	16.9 in	3.3 in	29.3 oz				
38/39	683 mm	215 mm	430 mm	84 mm	856 g	38 / 39	5 / 6	6 / 7	7 / 8
	26.9 in	8.5 in	16.9 in	3.3 in	30.2 oz				
40 / 41	700 mm	215 mm	430 mm	87 mm	880 g	40 / 41	6.5 / 7	7.5 / 8	8.5 / 9
	27.6 in	8.5 in	16.9 in	3.4 in	31.0 oz				
42/43	712 mm	215 mm	430 mm	92 mm	928 g	42 / 43	8 / 9	9 / 10	10 / 11
	28.0 in	8.5 in	16.9 in	3.6 in	32.7 oz				
44/45	725 mm	215 mm	430 mm	97 mm	994 g	44 / 45	10 / 10.5	11 / 11.5	12 / 12.5
	28.5 in	8.5 in	16.9 in	3.8 in	35.0 oz				
46/47	734 mm	215 mm	430 mm	103 mm	1059 g	46 / 47	11 / 12	12 / 13	13 / 14
	28.9 in	8.5 in	16.9 in	4.1 in	37.4 oz				

Chart measurements taken with 3mm boot with sole  
Fins could come labeled with EU and UK sizes only

Cressi's Size Chart is to be used as a reference only

# GARA NEW 2024 MODULAR TURBO BOOST

AGILITY & PERFORMANCE



The Gara Turbo Boost fin, an evolution of the Impulse design, exploits a revolutionary S-shaped wave deformation technology. This movement allows considerable elastic potential energy to be stored in the blade, which is released in the return of thrust. This fin is incredibly light, reducing fatigue without compromising performance.

## TECHNICAL FEATURES

- Extremely thin and light blade in compound made of elastomerized technopolymers developed by Cressi
- Stringer consisting of technopolymers with elastomeric loads with high flexural modulus
- Footpocket / blade angle of 29 degrees
- Modular detachable fin
- Superior performance
- Superior comfort
- Self adjusting foot pocket
- Powerful thrust return
- Flexible thermoplastic rubber
- Exceptional lightness
- Reduced fatigue
- Guaranteed superior performance



GARA TURBO FOOT POCKET

**FIN WEARABILITY:**

BARE FOOT	NEOPRENE SOCKS

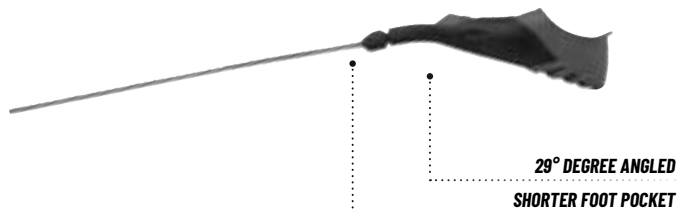

## INCLUDED GARA MODULAR INSOLE

The new insole for Gara Modular fins is recommended for use with thin boots in temperate waters, because it improves the kick performance. The semi-rigid material of the insole is completely recycled. The insoles are supplied as a pair (right and left foot) and can be cut into their shape in three different sizes, according to pre-printed guidelines.

- Down-size Gara Fins foot pocket preformed sole
- Easily adjust size
- Non-corrosive plastic construction



CODE	COLOR	SIZE	CASE PACK
BH185036	Black	36/37	3
BH185038	Black	38/39	3
BH185040	Black	40/41	3
BH185042	Black	42/43	3
BH185044	Black	44/45	3
BH185046	Black	46/47	3



# GARA MODULAR BOOST

NEW 2024

AGILITY & PERFORMANCE



The Gara Turbo Boost fin, an evolution of the Impulse design, exploits a revolutionary S-shaped wave deformation technology. This movement allows considerable elastic potential energy to be stored in the blade, which is released in the return of thrust. This fin is incredibly light, reducing fatigue without compromising performance.



29° DEGREE ANGLED

FINS WEARABILITY:

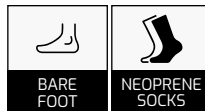

## TECHNICAL FEATURES

- Excellent propulsive performance without tiring anyone, beginners or professionals
- Extremely thin and light blade in compound made of elastomerized technopolymers developed by Cressi with different thicknesses
- Stringer consisting of technopolymers with elastomeric loads with high flexural modulus
- Footpocket / blade angle of 29 degrees
- Gara Modular's footpocket is wider than the other Gara fin models. We suggest to use it with neoprene socks in order to have a proper fit. For use without neoprene socks, we recommend to buy one smaller size
- Powerful thrust return
- Flexible thermoplastic rubber
- Exceptional lightness
- Reduced fatigue
- Guaranteed superior performance



- LIGHTER
- SOFTER
- 100% PROPULSIVE PERFORMANCE
- MORE EFFICIENCY
- LESS EFFORT

"ROUNDER" TAIL SPECIAL DESIGN IMPROVES FIN CONTROL AND DIRECTIONALITY

## INCLUDED GARA MODULAR INSOLE

The new insole for Gara Modular fins is recommended for use with thin boots in temperate waters, because it improves the kick performance. The semi-rigid material of the insole is completely recycled. The insoles are supplied as a pair (right and left foot) and can be cut into their shape in three different sizes, according to pre-printed guidelines.

- Down-size Gara Fins foot pocket preformed sole
- Easily adjust size
- Non-corrosive plastic construction

CODE	COLOR	SIZE	CASE PACK
BH125036	Green	36/37	3
BH125038	Green	38/39	3
BH125040	Green	40/41	3
BH125042	Green	42/43	3
BH125044	Green	44/45	3
BH125046	Green	46/47	3



## GARA MODULAR FOOT POCKET

### SELF-ADJUSTING FOOT POCKET

CODE	SIZE	CASE PACK
BH005036	36/37	10
BH005038	38/39	10
BH005040	40/41	10
BH005042	42/43	10
BH005044	44/45	10
BH005046	46/47	10



## GARA MODULAR TURBO FOOT POCKET

### SHORT SIDE RAILS FOOT POCKET

CODE	SIZE	CASE PACK
BH015036	36/37	10
BH005038	38/39	10
BH015040	40/41	10
BH015042	42/43	10
BH015044	44/45	10
BH015046	46/47	10



## GARA MODULAR ASSEMBLY KIT

CODE
BZ180020



## INSOLE FOR GARA FINS

CODE
BZ180022



# GARA MODULAR BLADES

## IMPULSE CARBON



CARBON



XLD



MD



CODE	PRODUCT	COLOR	CASE PACK
BH077000	GARA MODULAR IMPULSE BLADE - CARBON	Carbon	10
<b>NEW</b> BH061056	GARA MODULAR CARBON BLADE XLD - GREY CAMOU (1 PC)	Grey Camouflage	10
<b>NEW</b> BH062091	GARA MODULAR CARBON BLADE MD - GREEN CAMOU (1 PC)	Green Camouflage	10

# FINS THAT SAVE FINS

**GARA MODULAR BLADE**  
Designed By Cressi Ambassadors:  
Ocean Ramsey and Juan Shark

LIMITED  
SPECIAL  
EDITION



FRONT

BACK

## OCEAN RAMSEY SHARKS EDITION

**BLADES MATERIAL MEDIUM  
COMPOSITE FIBERGLASS**

The Composite Fibreglass is the world's most advanced composite diving fin blades. The customized hybrid epoxy resin system, coupled with state of the art design and aerospace grade fabric combine to create a fin that transfers the load to the larger muscle groups, instead of focusing on any one specific location. All the blades are hand made by DiveR in Australia and come with a 3-year warranty.

CODE	PRODUCT
WBH059902	GARA MODULAR BLADE OCEAN RAMSEY SHARKS EDITION

A PERCENTAGE OF THE CRESSI GARA MODULAR -LIMITED SPECIAL EDITION- BLADES SALES, WILL BE DONATED FOR THE SHARK CONSERVATION AT ONE OCEAN WATER INSPIRED NONPROFIT ORGANIZATION.

HOW-TO VIDEOS



BLACK

BLUE  
METAL

WHITE

# GARA MODULAR IMPULSE BLADES

CODE	PRODUCT	COLOR	CASE PACK
BH072000	GARA MODULAR IMPULSE BLADE - BLUE METAL	Blue	10
BH073000	GARA MODULAR IMPULSE BLADE - WHITE	White	10
BH075000	GARA MODULAR IMPULSE BLADE - BLACK	Black	10

# GARA 3000 LD

## LONG DISTANCE



The Gara 3000 LD is Cressi's entry-level long blade fin designed with softer blades, which makes the Gara 3000 a perfect choice for the beginning diver or those unexperienced with long-fin blades. The Gara 3000 is constructed with durability in mind and long soft plastic blades that can effectively transfer power with minimum effort. This makes the fin comfortable and easy on the legs for beginners as well as during long duration dives.

The Gara 3000 is an extremely comfortable and is a full footpocket style fin. This fin is also constructed using Cressi's unique three material molding process, where different compounds are bonded together to provide flexibility in the foot area, while being able to deliver power through the blade due to the stiffness the process provides. Can comfortably be worn with or without neoprene socks.

### TECHNICAL FEATURES

- Durable construction designed for extended use
- Soft long blade for less swimming effort
- Comfy full footpocket
- Cressi three material molding technology



CODE	SIZE	CASE PACK
BH135140	40/41	3
BH135142	42/43	3
BH135144	44/45	3
BH135146	46/47	3

### ACCESSORIES

CODE	PRODUCT
BZ175032	RUBBER FIN KEEPER (PAIR) - BLACK [S]
BZ175033	RUBBER FIN KEEPER (PAIR) - BLACK [M]
BZ175034	RUBBER FIN KEEPER (PAIR) - BLACK [L]
BZ180022	INSOLE FOR GARA FINN

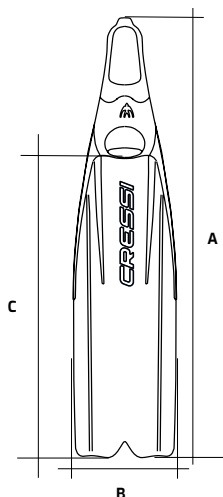

### FIT SIZE



To maximize performance and comfort, wear fins with:

<input checked="" type="checkbox"/>	<input checked="" type="checkbox"/>	<input type="checkbox"/>	<input type="checkbox"/>
BARE FOOT	NEOPRENE SOCKS	NEOPRENE BOOTS 3 mm 5 mm 7 mm	HARD SOLE BOOTS 3 mm 5 mm 7 mm

### PRODUCT DIMENSION CHART

FIN SIZE	A LENGTH	B WIDTH	C BLADE	SINGLE FIN WEIGHT
40/41	870 mm 24.3 in	210 mm 8.3 in	690 mm 27.2 in	861 g 1.89 lb
42/43	885 mm 34.9 in	210 mm 8.3 in	705 mm 27.8 in	952 g 2.09 lb
44/45	905 mm 35.7 in	215 mm 8.5 in	715 mm 28.2 in	984 g 2.16 lb
46/47	925 mm 36.5 in	220 mm 8.7 in	725 mm 28.6 in	1066 g 2.35 lb

### SIZE CONVERSION CHART

EU FOOT SIZE	UK FOOT SIZE	US MEN'S FOOT SIZE	US WOMEN'S FOOT SIZE
40/41	6.5 / 7	7.5 / 8	8.5 / 9
42/43	8 / 9	9 / 10	10 / 11
44/45	10 / 10.5	11 / 11.5	12 / 12.5
46/47	11 / 12	12 / 13	13 / 14

Chart measurements taken with 3mm boot with sole  
Fins could come labeled with EU and UK sizes only

Cressi's Size Chart is to be used as a reference only



# GARA 2000 HF

## HIGH FREQUENCY

Gara 2000 HF is an icon in the diving industry, and is the first fin in the industry to be manufactured using a three material molding process. Due to its lightweight and durability, it is an excellent choice for those looking for a fin that can provide the ultimate in performance while deep freediving and spearfishing, and those looking for obtaining maximum depths. The GARA 2000 has the stiffest blade in the CRESSI line and is an extremely comfortable full footpocket style fin, with long firm blades with built in stringers and runners to effectively direct water flow down the blade aiding in efficiency. This fin is constructed using multiple compounds bonded together to provide comfort and suppleness in the foot area and strength and rigidity in the heel and blade area. Can comfortably be worn with or without neoprene socks.



### TECHNICAL FEATURES

- Stiff Long Blade designed for maximum depths
- Full footpocket for comfort
- Long blade for efficiency



CODE	SIZE	CASE PACK
BH115040	40/41	3
BH115042	42/43	3
BH115044	44/45	3
BH115046	46/47	3

### ACCESSORIES

CODE	PRODUCT
BZ175032	RUBBER FIN KEEPER (PAIR) - BLACK (S)
BZ175033	RUBBER FIN KEEPER (PAIR) - BLACK (M)
BZ175034	RUBBER FIN KEEPER (PAIR) - BLACK (L)
BZ180022	INSOLE FOR GARA FINN

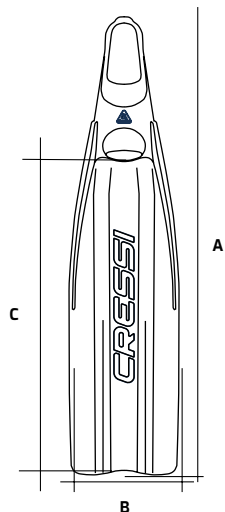

### FIT SIZE



To maximize performance and comfort, wear fins with:

<input checked="" type="checkbox"/>	<input checked="" type="checkbox"/>	<input type="checkbox"/>	<input type="checkbox"/>
BARE FOOT	NEOPRENE SOCKS	NEOPRENE BOOTS 3 mm 5 mm 7 mm	HARD SOLE BOOTS 3 mm 5 mm 7 mm

FIN SIZE	PRODUCT DIMENSION CHART				SIZE CONVERSION CHART			
	A LENGTH	B WIDTH	C BLADE	SINGLE FIN WEIGHT	EU FOOT SIZE	UK FOOT SIZE	US MEN'S FOOT SIZE	US WOMEN'S FOOT SIZE
40/41	845 mm 33.3 in	215 mm 8.5 in	660 mm 26 in	790 g 1.74 lb	40/41	6.5 / 7	7.5 / 8	8.5 / 9
42/43	860 mm 33.9 in	215 mm 8.5 in	660 mm 26 in	895 g 1.97 lb	42/43	8 / 9	9 / 10	10 / 11
44/45	875 mm 34.4 in	220 mm 8.7 in	675 mm 26.6 in	970 g 2.13 lb	44/45	10 / 10.5	11 / 11.5	12 / 12.5
46/47	890 mm 35 in	223 mm 8.8 in	675 mm 26.6 in	1030 g 2.27 lb	46/47	11 / 12	12 / 13	13 / 14

Chart measurements taken with 3mm boot with sole  
Fins could come labeled with EU and UK sizes only

Cressi's Size Chart is to be used as a reference only

# GARA PROFESSIONAL LD

## LONG DISTANCE

The Gara Professional LD is a high performance fin, requiring minimum effort to load the long blades. They are more forgiving than other long blade fins for untrained legs, making this an excellent choice for deep free divers and spearfishers of all levels. They are ideal for long distance swimming, while ultimately providing the power and efficiency needed for deep free-diving and spearfishing. Due to the multi compound bonding process used during the manufacturing process, the Gara Pro LD is an exceptionally soft full footpocket style fin, which provides comfort during prolonged use on those long days in the water. Gara Pro LD delivers maximum power with minimum energy through its long firm blade that runs over the footpocket. Can comfortably be worn with or without neoprene socks.



### TECHNICAL FEATURES

- Firm blade designed to run over the footpocket for ease of use
- Full footpocket for comfort
- Thermo-Rubber soles for extra grip on wet surfaces
- Stiff long blade designed for maximum depths
- Full footpocket for comfort
- Long blade for efficiency



2024 - CATALOG

CODE	COLOR	SIZE	CASE PACK
BH142040	Blue	40/41	3
BH142042	Blue	42/43	3
BH142044	Blue	44/45	3
BH142046	Blue	46/47	3
BH145140	Black	40/41	3
BH145142	Black	42/43	3
BH145144	Black	44/45	3
BH145146	Black	46/47	3

### ACCESSORIES

CODE	PRODUCT
BZ175032	RUBBER FIN KEEPER (PAIR) - BLACK (S)
BZ175033	RUBBER FIN KEEPER (PAIR) - BLACK (M)
BZ175034	RUBBER FIN KEEPER (PAIR) - BLACK (L)
BZ180022	INSOLE FOR GARA FINN



BLUE

BLACK

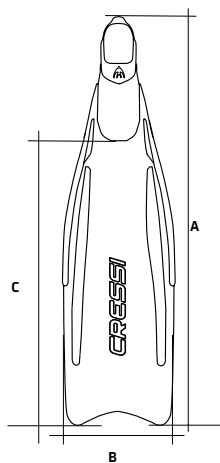

### FITSIZE



To maximize performance and comfort, wear fins with:

✓	✓		
BARE FOOT	NEOPRENE SOCKS	NEOPRENE BOOTS	HARD SOLE BOOTS

### PRODUCT DIMENSION CHART

FIN SIZE	A LENGTH	B WIDTH	C BLADE	SINGLE FIN WEIGHT	EU FOOT SIZE	UK FOOT SIZE	US MEN'S FOOT SIZE	US WOMEN'S FOOT SIZE
40/41	870 mm 34.3 in	220 mm 8.7 in	730 mm 29 in	861 g 1.89 lb	40 / 41	6.5 / 7	7.5 / 8	8.5 / 9
42/43	890 mm 35.1 in	225 mm 8.9 in	750 mm 30 in	952 g 2.09 lb	42 / 43	8 / 9	9 / 10	10 / 11
44/45	900 mm 35.5 in	233 mm 9.2 in	750 mm 30 in	984 g 2.16 lb	44 / 45	10 / 10.5	11 / 11.5	12 / 12.5
46/47	915 mm 36.1 in	242 mm 9.5 in	770 mm 30 in	1066 g 2.35 lb	46 / 47	11 / 12	12 / 13	13 / 14

### SIZE CONVERSION CHART

Chart measurements taken with 3mm boot with sole  
Fins could come labeled with EU and UK sizes only

Cressi's Size Chart is to be used as a reference only

CRESSI

# GARA PROFESSIONAL SET 3.0

GARA PROFESSIONAL LD FINS + METIS MASK + CORSICA SNORKEL

Cressi made this set composed by professional items, of high quality and performance, to give the opportunity to use a high standard equipment for freediving and for spearfishing.



CODE	COLOR	SIZE
SE401040	Black	40/41
SE401042	Black	42/43
SE401044	Black	44/45
SE401046	Black	46/47
SE402040	Blue	40/41
SE402042	Blue	42/43
SE402044	Blue	44/45
SE402046	Blue	46/47

## RUBBER FIN KEEPER

KEEP THE FOOT POCKET TIGHT AGAINST THE HEEL

The simple things in life often turn out to be the most useful and Fin Keepers are a perfect example. Their benefit is great especially if your foot pocket fits a little loose. They are a simple, inexpensive concept that works great, they last for years, yet rarely mentioned. Fin keepers keep the foot pocket tight against the heel giving the diver full fin power. You can't truly appreciate them until you use them. When you do, you will notice the difference in power instantly. By holding the foot pocket against the bottom of the heel they limit or delete lost power. Without fin keepers every time you kick the fin the foot pocket will lift off your heel. Just a 1/4" of movement away from the heel will result in major power loss. Power is lost but spent energy is unchanged.



CODE	SIZE	CASE PACK
BZ175032	S	10
BZ175033	M	10
BZ175034	L	10





**MASKS**  
FREEDIVING





# ATOM

## ULTRA LOW VOLUME MASK



Atom is a radical mask, with incredible low internal volume, thought and built for freediving. It is a frameless mask. Construction material has been reduced to the minimum. Inside the silicone facial a stiff core is co-stamped with the two lenses, giving just the right rigidity to the mask. This semi-rigid core substitutes the usual external plastic frame and allowed us to reduce the internal volume of the mask in an unseen way until today.

Another feature of Atom is the ergonomic shape of the nose. Two small cavities, carved by the nostrils, facilitate the action of compensation. This makes the mask extremely stable during the dive. Atom will not move when you compensate pushing.

Atom is the perfect mask for the expert free-diver and spear-fisher, who wants the maximum performance from its gear.



BLUE METAL

WHITE

BLACK

GREEN

CODE	COLOR
D5522050	Blue Metal/Black
D5523050	White/Black
D5525050	Black/Black
D5527550	Green/Black



### TECHNICAL FEATURES

- Ultra low-volume mask, designed to facilitate the action of compensation
- Rigid co-stamped stiff core
- Ergonomic shape of the nose, design for facilitate the action of compensation
- Ideal for expert free-diver and spear-fisher

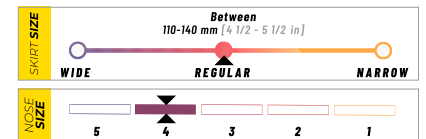
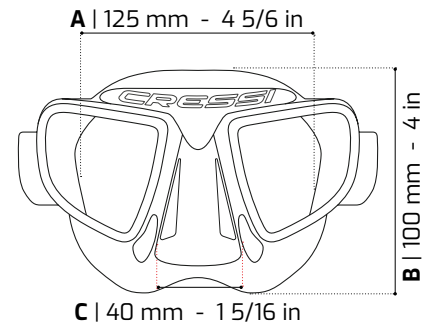

### PROFILE VIEW

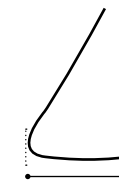

E | 24 mm - 15/16 in

### PRODUCT DIMENSION CHART (SKIRT SIZE)

A - WIDTH	B - HEIGHT	C - NOSE LENGTH	D - NOSE HEIGHT	E - NOSE WIDTH
129 mm 5 1/16 in	101 mm 4 in	33 mm 1 5/16 in	54 mm 2 2/16 in	24 mm 15/16 in

Cressi's Size Chart is to be used as a reference only



# CALIBRO

## PATENTED INNOVATIVE FOG STOP SYSTEM



### TECHNICAL FEATURES

- Cressi's patented Fog-Stop system
- Integrated Dual Frame Technology
- Low volume mask
- Tempered glass lenses
- Micrometric adjustable buckle
- Flexible and swiveling buckles for a comfort fit

### COATED LENSES

FEATURES DETAILS  
Pag 141

**SKIRT SIZE**

<b>WIDE</b>	<b>REGULAR</b>	<b>NARROW</b>
Above 150mm 5 1/2 in	Between 110/140mm 4 1/2-5 1/2 in	Less than 130 mm 4 1/2 in

**NOSE SIZE**

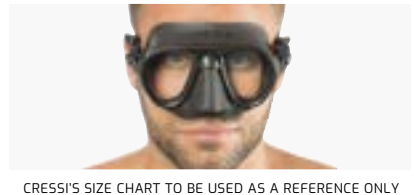

Cressi's next generation diving masks are all equipped with the Integrated Dual Frame Technology which offers exceptional field of view, and the new Calibro is no exception. The mask is designed so that the integrated face and frame allow for an extremely hydrodynamic and compact shape and a particularly wide lens, maintaining the mask extremely close to the face. Cressi's Calibro combines minimal internal volume with a phenomenal field of view due to the raked angle of the frame.

The buckles are, as always, directly integrated into the rigid skirt through a solid but flexible rubber attachment that allows you to adjust and place the mouthpiece without shifting the mask. Thanks to its matte coating the mask's components all match, enhancing the underwater experience since it prevents reflections in the water that may disturb marine life. Calibro is the perfect mask for freediving since it is designed to provide the diver with a feeling of total freedom and comfort.



CODE	COLOR	CASE PACK
D5425050	Black	6
D5429850	Green	6
D5426050	Black - Spectra lens	6

2024 - CATALOG

CRESSI

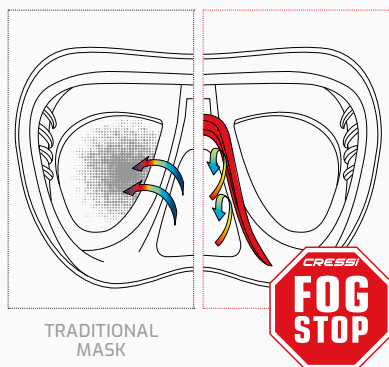

# NANO

85 CM3: ULTRA LOW VOLUME



## TECHNICAL FEATURES

- Internal volume just 85 cm<sup>3</sup> | 5.2 cu in
- Reduced lens-face distance
- Inclined lenses and slender structure optimize visibility
- Swivel buckles with micrometric adjustment
- Lenses in tempered glass
- Anatomical strap

**COATED LENSES**

FEATURES DETAILS  
Pag 141



The Nano is for advanced divers, freediving and spearfishing lovers, designed to offer an extremely hydrodynamic and compact shape to help divers cut through the water and aid movements in small spaces. To develop the Nano mask, Cressi invented and patented the Integrated Dual Frame Technology which joins the silicone skirt to the rigid frame lens without interruptions to guarantee a perfect seal and drastically reduce the internal volume. It does not require intentional equalizing. The swiveling buckles feature micrometric regulation. The mask features inverted teardrop lenses slightly inclined made in tempered glass. An anatomical strap ensures a perfect seal on the head. Available with mirrored lenses to hide your eyes while attracting fish.

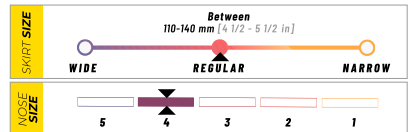
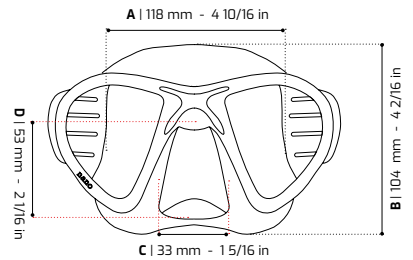

CRESSI'S SIZE CHART TO BE USED AS A REFERENCE ONLY



CODE	PRODUCT	CASE PACK
DS365050	NANO - BLACK/BLACK	6
DS365550	NANO - BLUE/BLACK METAL	6
DS366050	NANO - BLACK/BLACK - SPECTRA LENS	6
DS369850	NANO - GREEN/GREEN	6



## CRESSI PATENTED TECHNOLOGIES

### ★ INCLINED GLASSES US 6272693 B1

Cressi has developed and patented in 2001 a particular mask frame that to solve the problem of the divers not being able to easily see the scuba equipment. A scuba diver carrying many different pieces of equipment, some of them are vital like the pressure and depth gauges. The solution has been found designing a new frame shape that is inclined downwards. Moreover, the shape of the lens is designed like an inverted teardrop increasing drastically the downward visibility.

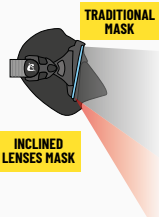

### ★ INTEGRATED BUCKLES US 8281417 B2

The patented technology is to provide a mask for aquatic activities that avoid loss of watertight during strap-tightening by a diver when the mask is in use underwater. The object of the invention is to avoid exertion of a tensile force or stress during mask adjustment and, in turn, rupture of the skirt. The buckles are not directly fixed

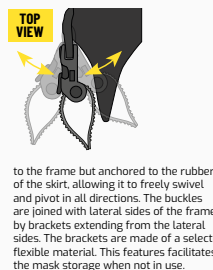

### ★ INTEGRATED DUAL FRAME US 20140013494 A1

The Patented Integrated Dual Frame Technology consists of the joining of two rigid frames, the first on the rear of the silicone skirt and the second, anterior to the first one, that support the lenses. When the two frames are joined and locked together, the silicone skirt remains locked in the middle to guarantee a perfect seal between the face piece and the lens. This technology produces a drastic reduction in the internal volume, while keeping the lenses close to the eyes to ensure a wide view laterally and in the lower zone. The result is a mask with an extremely hydrodynamic shape and low volume.



# ROMBO NEW 2024



Rombo is a frameless mask that boasts a low internal volume which makes it excellent for freediving, snorkeling, and/or spearfishing. The specific design uses the assembly of the silicone skirt directly over the single tempered glass. This system guarantees superb sturdiness and the perfect watertight seal. The low weight of the mask makes it ideal for packing and travel. The flexible fit and reduced drag makes it an excellent choice for freediving, snorkeling, and/or spearfishing. The micro-metrically adjustable buckles are comfortable and effective, making adjusting the Rombo quick and easy.



BLACK



CLEAR



WHITE



BLACK

**SPECTRA MIRRORED LENSES**  
60% UV  
SEMI-REFLECTIVE



**COATED LENSES**

FEATURES  
DETAILS  
Pag 141

CODE	COLOR
DN300000	Clear
DN303030	White
DN305050	Black
DN305150	Black - Spectra lens



Photo by: voyagesofagape



# METIS

NEW COLOR 2024



It is a mask specifically designed for spearfishing, but it's also suitable for scuba diving. It has two windows and a high-quality silicone skirt that is more comfortable and longer-lasting than traditional PVC plastic. The silicone skirt is adaptable to different face shapes and ensures a perfect seal. The strap is also made of silicone, large and wide behind the neck to provide a tight and comfortable fit. The length of the strap is adjustable with easy-to-use buckles. You have the option to choose different lenses, such as colored or mirrored, to enhance your underwater view. All lenses are made of tempered glass, ensuring they are shatterproof and scratch-resistant. The nose pocket is soft and easy to access, allowing for proper equalization using only two fingers, even when wearing gloves.

### TECHNICAL FEATURES

- Low internal volume
- Inverted teardrop lenses shape
- Soft silicone skirt
- Very light
- Available in Ultraview lenses to increase vision clearness

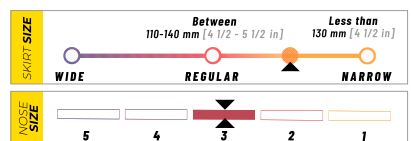
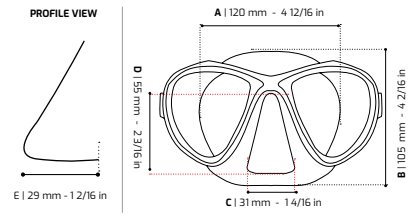
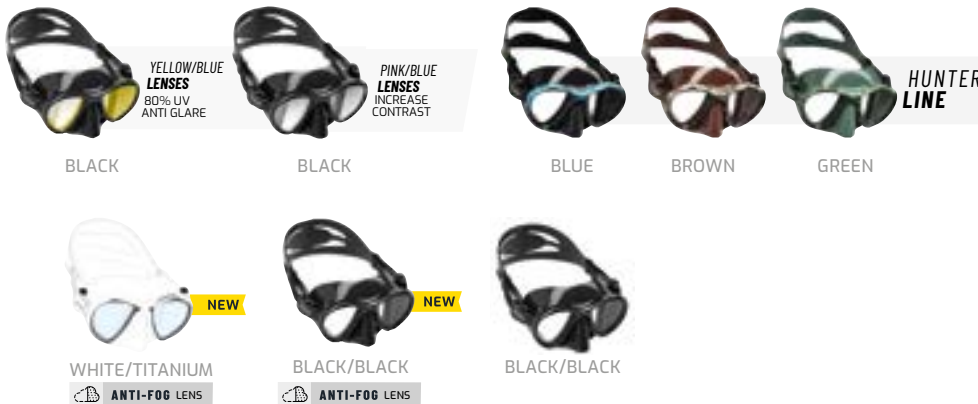

CODE	COLOR	CASE PACK
US411010	BLACK/BLACK-YELLOW LENSES	10
US411050	BLACK/BLACK-SPECTRA MIRROR LENSES	10
US411223	BLUE HUNTER	10
US411253	BROWN HUNTER	10
US411293	GREEN HUNTER	10
US411500	BLACK/BLACK	10
NEW US415550	BLACK/BLACK - CLEAR ANTI-FOG LENS	10
NEW YDM423072	WHITE/TITANIUM-CLEAR ANTI-FOG LENS	10

### PRODUCT DIMENSION CHART (SKIRT SIZE)

A - WIDTH	B - HEIGHT	C-NOSE LENGTH	D-NOSE HEIGHT	E-NOSE WIDTH
120 mm 4 12/16 in	105 mm 4 2/16 in	31 mm 1 4/16 in	55 mm 2 3/16 in	29 mm 1 2/16 in

Cressi's Size Chart is to be used as a reference only  
 ++ Measure ear to ear with a ruler

SPARE PARTS

CODE	PRODUCT
DZ222050	STRAP for SCUBA MASK TW - BLACK
DZ221050	BUCKLES for SCUBA MASK TW - BLACK/BLACK
DZ215012	STRAP LOOP for SCUBA MASK TW - BLACK (PAIR)

COATED LENSES

STANDARD SPECTRA

FEATURES DETAILS PAG 141

SPECTRA LENS INCREASE THE VISION'S CLEARNESS BY 15%

# FOCUS

## OPTICAL MASK



The ultimate in versatility, this classic mask offers the best fit and performance for the greatest variety of facial shapes. Its low-volume, twin-lens design gives divers and snorkelers a proven combination of size, fit and durability. Lightweight and easy-to-clear it has swiveling, quick-adjust buckles and accepts corrective lenses. It is also an excellent value.



BLACK/BLUE

BLACK/BLACK

CODE	COLOR	CASE PACK
DS242020	Black/Blue	6
DS242050	Black/Black	6

### SPARE PARTS

CODE	PRODUCT
DZ210010	BUCKLES - BLACK for FOCUS/SKY
DZ215004	SILICONE STRAP - BLACK for ITALIAN SCUBA MASK
DZ215011	STRAP LOOP SMALL for PRO DIVE MASKS - BLACK (PAIR)

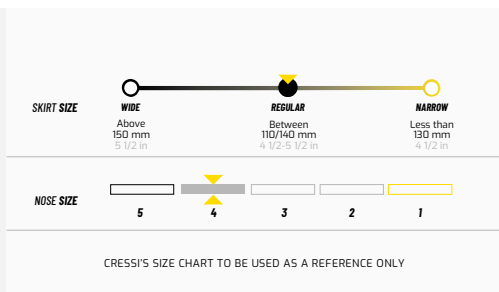
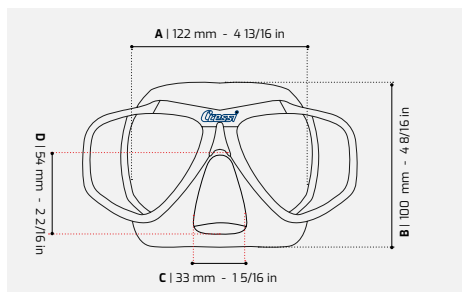

### TECHNICAL FEATURES

- Low internal volume allows for effortless clearing
- Lightweight, compact and rugged
- Ideal for travel or as a backup mask
- High-grade silicone skirt provides a leak-free seal
- Fixed quick-adjusting buckles

### OPTICAL LENSES POSSIBILITY OF MOUNTING OPTICAL LENSES

• CORRECTION -1.0 > -6.00



LEFT AND RIGHT FROM DI240010 TO DI240080

• BIFOCAL LENS - CORRECTION +1.0 > +4.0



LEFT FROM DI240110 TO DI240140

RIGHT FROM DI240210 TO DI240240



### SYMMETRICAL LENSES

- The lenses are available positive for correcting nearsightedness (**myopia**).
- The lenses are available with bifocal optics for corrective farsightedness (**hyperopia**).

OPTICAL LENSES INSTALLATION \$5.00

COMPLETE INFORMATION OPTICAL LENSES PLEASE REFER TO PAGE 144 CHART

CODE	PRODUCT
DI240010	Optical Lens -1.0
DI240015	Optical Lens -1.5
DI240020	Optical Lens -2.0
DI240025	Optical Lens -2.5
DI240030	Optical Lens -3.0
DI240035	Optical Lens -3.5
DI240040	Optical Lens -4.0
DI240045	Optical Lens -4.5
DI240050	Optical Lens -5.0
DI240055	Optical Lens -5.5
DI240060	Optical Lens -6.0
DI240065	Optical Lens -6.5
DI240070	Optical Lens -7.0
DI240075	Optical Lens -7.5
DI240080	Optical Lens -8.0

# SUPEROCCCHIO

CLASSIC LOW VOLUME MASK



## TECHNICAL FEATURES

- Minimum internal volume
- Suitable for deep freediving
- The size of the skirt is reduced, and the mask adapts easily to many facial shapes
- The two separate lenses, placed very near the eyes, offer great visibility in every direction

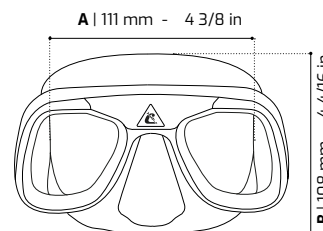

Superocchio is the grand classic in the Cressi line, it is still a favorite among many divers through its many years of availability. Superocchio is small, compact and provides low internal volume, which makes it a great choice for deep diving and spearfishing due to its low internal volume, which allows for minimal effort from the diver to comfortably equalize during descent.

The allergy free black silicone skirt protects the diver's eyes from unwanted back glare and distraction while spearing. The soft silicone mask strap comes with easy and quick adjusting buckles to help provide a comfortable precise fit and can be easily manageable even when wearing neoprene gloves.



CODE	COLOR	CASE PACK
DN234650	Black/Black	6



PACKAGING

# MINIMA

THE LOWEST VOLUME ON THE MARKET



This mask was designed specifically for deep sea diving, with innovative features that place it at the top of its category. The special reduced skirt, complete with a small seal ring, sticks like a suction cup to the face, leaving minimum air space inside the mask, which make compensation extremely easy, taking very little air from the lungs.

The lens-eye distance is the absolute smallest on the market and guarantees, even with small diameter lenses, excellent visibility in all directions. The two optic glass lenses are thicker than the standard to allow a special safety mould. The strap comes with instantly adjusting buckles for an easy and precise fit.

CODE	COLOR	CASE PACK
DS292050	Black/Black	6

## TECHNICAL FEATURES

- **Materials:** liquid silicone, hi-tech polymers
- **Strap buckles:** instant adjustment
- Internal very low volume
- **Dimensions of frame:** 168 x 45 mm
- **Weight:** 118 g

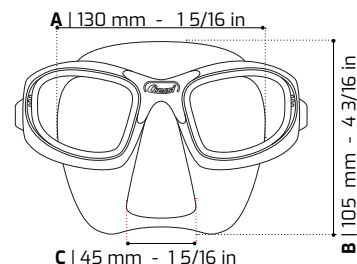

PACKAGING

# PACIFICO



CODE	CASE PACK
ZDN320050	10

RUBBER MASK

ALSO FOR RENTAL

## TECHNICAL FEATURES

- Single lens in a classic retro oval shape
- Scratch resistant tempered glass for clarity and safety
- Rubber skirt and strap for great seal and comfort
- Easily adjustable buckles

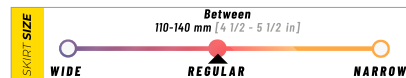
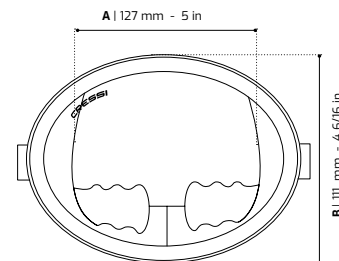

### PRODUCT DIMENSION CHART (SKIRT SIZE)

A - WIDTH (mm)	B - HEIGHT (mm)	A - WIDTH (in)	B - HEIGHT (in)w
127	111	5	4 6/16

Cressi's Size Chart is to be used as a reference only





# CALIBRO & CORSICA

CALIBRO MASK + CORSICA SNORKEL



BLUE METAL

GREEN

BLACK



## TECHNICAL FEATURES

- Designed specifically for Freediving and Spearfishing
- Low internal volume allows the diver less effort to equalize
- Black allergy free silicone skirt to prevent back reflection
- Tempered glass lenses
- Easily adjustable mask strap and buckles
- Skirt design allows for fit of a multitude of face types

CODE	COLOR	CASE PACK
D5434550	Blue Metal	10
D5435050	Black	10
D5439850	Green	10

# CORSICA

Corsica is a highly technical snorkel designed specifically for deep freediving and spearfishing. The soft bendable large diameter tubing makes it extremely comfortable to properly position behind the head while maintaining ease of breathing on the surface. When diving, the mouthpiece tucks neatly under the chin for the ultimate in hydrodynamics. The anatomical hypoallergenic silicone mouthpiece provides extreme comfort during long duration in the water. The Corsica is available in either solid or camouflage color and is an excellent choice for the discriminating diver who is looking for the best equipment.



## TECHNICAL FEATURES

- Anatomical hypoallergenic silicone mouthpiece provides extreme comfort during prolonged use
- Soft bendable snorkel tube to maintain proper and comfortable positioning
- Large diameter snorkel tube provides unobstructed ease of breathing
- Specially designed and molded U-Bend
- Provides easier clearing capability



ULTRA FLEXIBLE TUBE



BLUE HUNTER



BROWN HUNTER



GREEN HUNTER



TURQUOISE



WHITE



PINK FLUO



BLUE METAL



GREEN



BLACK

CODE	COLOR	CASE PACK
EG268523	Camo Blue	12
EG268528	Turquoise	12
EG268530	White	12
EG268545	Pink Fluo	12
EG268550	Black/Black	12
EG268553	Camo Brown	12
EG268555	Blue	12
EG268593	Camo Green	12
EG268598	Green/Black	12



POLYBAG





# AMERICA



POLYBAG

CODE	CASE PACK
EG267050	12

## TECHNICAL FEATURES

- The multi-positional silicone soft mouthpiece provides extreme comfort during prolonged use
- Large diameter tube provides unobstructed ease of breathing
- Minimal tube and mouthpiece bends provide easier clearing capability

# GRINGO

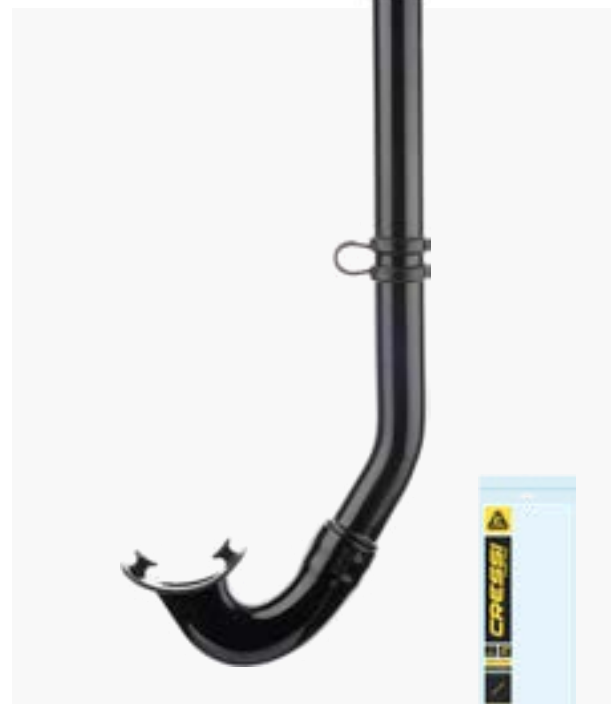

POLYBAG

CODE	CASE PACK
EG266000	12

## TECHNICAL FEATURES

- The multi-positional silicone soft mouthpiece provides extreme comfort during prolonged use
- Large diameter Snorkel Tube provides unobstructed ease of breathing
- Minimal tube and mouthpiece bends provides easier clearing capability





**WETSUITS**  
FREEDIVING





# FISTERRA

TWO-PIECE WETSUIT 8 mm



- ### TECHNICAL FEATURES
- Low-compression neoprene for optimum thermal protection
  - Nylon outer lining of high weight very resistant
  - Interior X-Plush elastic terry loop, waterproof and great sliding
  - Wide anti-abrasion knee-spin pads in Supratex®



ELASTIC PLUSH INSIDE

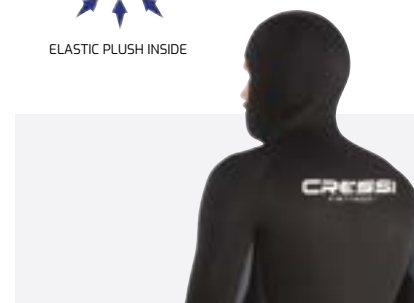

Fisterra has been developed to respond to the need for professional divers in cold waters. It's a robust wetsuit also ideal for commercial fishing. The demand for professional divers, diving instructors, and users who demand maximum thermal performance and comfort has encouraged us to introduce a warm wetsuit for cold water. It is a resistant, very watertight, and high thermal combination with a jacket without zippers and high trousers with dungarees. A combination that combines, therefore, characteristics that place it

at the apex of pure performance in a wetsuit of this thickness. Low-compression neoprene that guarantees optimum thermal protection at the bottom due to its high resistance to compression is ideal for professional work or long-duration diving. Nylon outer lining of high weight very resistant, interior X-Plush elastic terry loop, waterproof and great sliding that facilitates the placement and removal of the suit at the same time has a large thermal memory. Wide anti-abrasion knee-spin pads and elbow pads in Supratex®.

CODE	SIZE	CASE PACK
LK489502	S	5
LK489503	M	5
LK489504	L	5
LK489505	XL	5
LK489506	2XL	5
LK489507	3XL	5

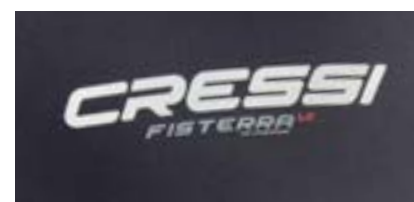

# LAMPUGA

## TWO-PIECE WETSUIT



Inspired by the livery of the pelagic fish. A special digital printing system has been used for this new camouflage wetsuit, allowing high resolution images to be obtained and thus create an exclusive camouflage design. The new "Cryptic Camouflage Technology" of Cressi is based on a real image of

a fish (a dolphin fish in this case, with its dominant colours), to create camouflage that is very close to the original and then altered to obtain a repetitive effect that is one of a kind. The materials used are: high elastic camo on the outside, open-cell neoprene on the inside.

5 mm

CODE	SIZE	CASE PACK
LU490102	S	5
LU490103	M	5
LU490104	L	5
LU490105	XL	5
LU490106	2XL	5

3 mm

CODE	SIZE	CASE PACK
LU490112	S	5
LU490113	M	5
LU490114	L	5
LU490115	XL	5
LU490116	2XL	5
LU490117	3XL	5

### TECHNICAL FEATURES

- Preformed anatomical cut
- Jacket with padded reinforcement on the chest
- Watertight seals in smooth skin on hood, wrists and ankles
- Reinforced anti-abrasion lining on the chest and knees
- High-waisted trousers with watertight seals on the ankles and waist



SMOOTH SKIN WATERTIGHT SEALS



PROTECTIVE REINFORCEMENT

AQUA STOP SYSTEM



SINGLE PIECE UNDERARM SECTION



CHEST REINFORCEMENT

KNEEPAD



# SEPPIA

## TWO-PIECE WETSUIT



SMOOTH SKIN WATERTIGHT SEALS



KNEEPAD

SINGLE PIECE  
UNDERARM SECTION

### When wet changes colour accentuating mimetism!

Wetsuit created with the exclusive Cressi green/brown camouflage, computer-designed to make it more difficult for prey to create solid images, thereby confusing the wearer with the background.

Performed anatomical cut. Jacket with padded reinforcement on the chest. Smooth skin with watertight seals on hood, wrists, and ankles, Reinforced anti-abrasion lining on the chest and knees. High-waisted trousers with watertight seals on the ankles and waist.

7 mm

CODE	SIZE	CASE PACK
XLE468702	S	5
XLE468703	M	5
XLE468704	L	5
XLE468705	XL	5
XLE468706	2XL	5

5 mm

CODE	SIZE	CASE PACK
XLE468502	S	5
XLE468503	M	5
XLE468504	L	5
XLE468505	XL	5
XLE468506	2XL	5





# APNEA

## TWO-PIECE WETSUIT



**TECHNICAL FEATURES**

- Made of black-metallite Neoprene
- Chest reinforcement
- Knee pads
- Interior in open cell Neoprene

**HIGH WAISTED TROUSERS**

**PROTECTIVE REINFORCEMENT**

A well-cut suit with particular attention to comfort around the areas where the body suffers most friction. Internal layer in metallic black and a thickness of 3.5

mm and 5 mm. New design of the loading/reloading chestplate and special kneepads for extra protection.

7 mm

CODE	SIZE	CASE PACK
LE450302	S	5
LE450303	M	5
LE450304	L	5
LE450305	XL	5
LE450306	2XL	5
LE450307	3XL	5

5 mm

CODE	SIZE	CASE PACK
LE450202	S	5
LE450203	M	5
LE450204	L	5
LE450205	XL	5
LE450206	2XL	5
LE450207	3XL	5

3.5 mm

CODE	SIZE	CASE PACK
LE450102	S	5
LE450103	M	5
LE450104	L	5
LE450105	XL	5
LE450106	2XL	5
LE450107	3XL	5

**CHEST REINFORCEMENT**      **KNEEPAD**

# TOKUGAWA

2-PIECE WITH HOOD



The Tokugawa wetsuit is an excellent spearfishing and freediving wetsuit. It was designed by the Cressi Australia team, with the knowledge and help of the Italian Cressi family, based on the market-leading Apnea wetsuit pattern. It was designed specifically for use in blue waters as a perfect hardwearing spearfishing and pool training suit. The unique camouflage adapts to different water environments

— from the blue waters of the Caribbean Sea to the greener tones of the Northern USA. It is manufactured with flexible, comfortable, soft neoprene. This material is designed for flexibility. This wetsuit is named in honor of the Tokugawa shogunate — The Tokugawa shogunate was the last feudal Japanese military government, which existed between 1600 and 1868.

OPEN CELL 3.5 mm

CODE	SIZE	CASE PACK
LU490022	S	5
LU490023	M	5
LU490024	L	5
LU490025	XL	5
LU490026	2XL	5
LU490027	3XL	5

NYLON CLOSED CELL 2 mm

CODE	SIZE	CASE PACK
LU490032	S	5
LU490033	M	5
LU490034	L	5
LU490035	XL	5
LU490036	2XL	5
LU490037	3XL	5

## TECHNICAL FEATURES

- Blue camouflage pattern
- Anatomical cuts
- Chest loading pads
- Knee pads
- Interior reinforced with Nylon



HOOD

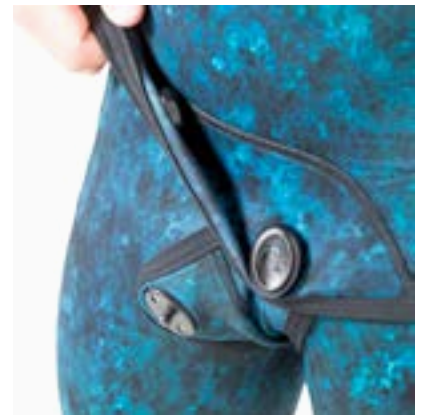

PROTECTIVE REINFORCEMENT



CHEST REINFORCEMENT



KNEEPAD

# TOKUGAWA

MONOPIECE WETSUIT | 3 mm



Designed for blue water spearfishing Tokugawa, named after the Japanese feudal shogunate, is a one-piece 3 mm thick wetsuit, perfect for spearfishing, and freediving. The unique camouflage of this wetsuit is appropriate for different aquatic environments, from the blue waters of the Caribbean Sea to the greener tones of North American waters. The wetsuit's graphics provide the ultimate camouflage for all environments. It is made of elastic, flexible, comfortable, and neoprene,

and has an anatomically designed cut specific to Cressi wetsuits, with preformed arms and legs that improve wearability and movement in the water. The chest and knee pad reinforcements are designed specifically for spearfishing. The Dura Stretch nylon lining improves the wetsuit's elasticity, comfort, and durability.

3 mm

CODE	SIZE	CASE PACK
LU490002	S	10
LU490003	M	10
LU490004	L	10
LU490005	XL	10
LU490006	2XL	10
LU490007	3XL	10



## TECHNICAL FEATURES

- Camouflage design ideal for blu waters
- Dura Stretch nylon lining
- Reinforced chest and knee pad



REINFORCED SEAMS ON WRISTS AND ANKLES



BACK ZIP



CHEST REINFORCEMENT



KNEEPAD



# COBIA

LONG SLEEVES  
CAMOU RASHGUARD



The Cobia is the ultimate rash guard that features a chest area completely made in 1 mm premium Neoprene to provide extra warmth. It's hooded to give the opportunity to protect and to heat also the head.

The Cobia can be worn under a wetsuit to give more warmth and protection. Can be used in any water sports, from windsurfing to scuba diving.

## TECHNICAL FEATURES

- The Cobia is the ultimate rash guard that features a chest area completely made in 1 mm premium Neoprene to provide extra warmth.
- Hood for head protection.
- Wearable under or over a wetsuit for improve the warmth.
- Available in Cressi's mimetic pattern blue.
- Excellent anatomic cuts.

NEOPRENE CHEST CHEST PAD



SMOOTH SKIN WATERTIGHT SEALS



SUGGESTED WATER TEMPERATURE

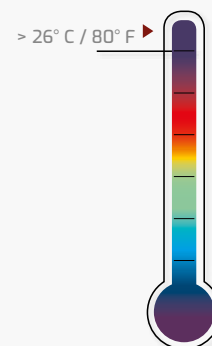

### BLUE

CODE	COLOR	SIZE	CASE PACK
USW01102B	Camo Blue	S	10
USW01103B	Camo Blue	M	10
USW01104B	Camo Blue	L	10
USW01105B	Camo Blue	XL	10
USW01106B	Camo Blue	2XL	10
USW01107B	Camo Blue	3XL	10

### GREEN

CODE	COLOR	SIZE	CASE PACK
USW011202G	Camo Green	S	10
USW011203G	Camo Green	M	10
USW011204G	Camo Green	L	10
USW011205G	Camo Green	XL	10
USW011206G	Camo Green	2XL	10
USW011207G	Camo Green	3XL	10

# HUNTER RASH GUARD

## LOADING CHEST PAD

The Hunter is a rash guard made with strong and elastic synthetic fabric. Made with anatomical cuts and can be worn in any water sports. Protects from wind and from UPF Ultraviolet rays. The chest is seamless and features a soft durable pad that protects the body. Can be worn over a wetsuit that does not have chest loading pad. Available in Cressi's mimetic patterns.



BLUE

CODE	COLOR	SIZE	CASE PACK
USW010102B	Camo Blue	S	5
USW010103B	Camo Blue	M	5
USW010104B	Camo Blue	L	5
USW010105B	Camo Blue	XL	5
USW010106B	Camo Blue	2XL	5
USW010107B	Camo Blue	3XL	5

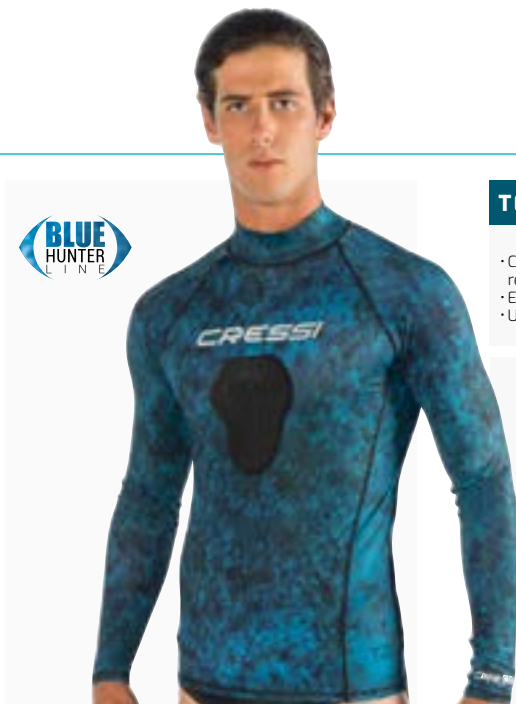

GREEN

CODE	COLOR	SIZE	CASE PACK
USW010202G	Camo Green	S	5
USW010203G	Camo Green	M	5
USW010204G	Camo Green	L	5
USW010205G	Camo Green	XL	5
USW010206G	Camo Green	2XL	5
USW010207G	Camo Green	3XL	5

### TECHNICAL FEATURES

- Camo patterns for blue water and reef environments
- Excellent anatomical cuts
- UPF U/V rays protection



# HUNTER RASH GUARD PANTS

The Hunter is a rash guard made with strong and elastic synthetic fabric. Made with anatomical cuts and can be worn in any water sports. Protects from wind and from UPF Ultraviolet rays. It features a knee protection pad. Can be worn as is or over a wetsuit. The rash guard matches the Cressi's blue camouflage pattern.



BLUE

CODE	COLOR	SIZE	CASE PACK
LW478102	Camo Blue	S	10
LW478103	Camo Blue	M	10
LW478104	Camo Blue	L	10
LW478105	Camo Blue	XL	10
LW478106	Camo Blue	2XL	10
LW478107	Camo Blue	3XL	10



GREEN

CODE	COLOR	SIZE	CASE PACK
LW478202	Camo Green	S	10
LW478203	Camo Green	M	10
LW478204	Camo Green	L	10
LW478205	Camo Green	XL	10
LW478206	Camo Green	2XL	10
LW478207	Camo Green	3XL	10

### TECHNICAL FEATURES

- Made with strong and elastic synthetic fabric.
- Anatomical cuts
- Protects from wind and from UPF ultraviolet rays



# CANARIE LT NEW 2024

ERGONOMIC THERMAL SOCKS | 4 mm - 2 mm

Designed with left and right feet to fit every curve and bend with each foot movement. The Premium Ultra-stretch Neoprene will be your "second foot," lined with elastic nylon. Ideal for keeping your feet warm underwater and preventing any abrasion caused by extensive training, rocks, or jellyfish. These are the only soft-soled neoprene socks you'll ever need for Spearfishing, Freediving, Surfing, Canyoneering, Watercraft, or any water sports you want to practice.



**SOCKS SIZE CHART**

SIZE DETAILS  
Pag 432

4 mm

CODE	SIZE
LX461452	S
LX461453	M
LX461454	L
LX461455	XL
LX461456	2XL

2 mm

CODE	SIZE
LX461252	S
LX461253	M
LX461254	L
LX461255	XL
LX461256	2XL

# CANARIE ST NEW 2024

ERGONOMIC THERMAL SOCKS | 2 mm

The Canarie socks are designed with left and right feet to fit every curve and bend with each foot movement. The Premium Ultra-stretch Neoprene will be your "second foot," lined with elastic nylon. Ideal for keeping your feet warm under water and in preventing any abrasion caused by extensive training, rocks, or jellyfish. These are the only soft-soled neoprene socks you'll ever need for Spearfishing, Freediving, Surfing, Canyoneering, Watercraft, or any water sports you want to practice.



CODE	SIZE
LX460252	S
LX460253	M
LX460254	L
LX460255	XL
LX460256	2XL

### TECHNICAL FEATURES

- Waterleg-seal. Keeps water out. Perfect adhesion and retains heat
- Blind and glued stitches. Improved durability, and ad comfort
- Abrasion resistant toe guard. For Extra Protection and Prolonged life of the socks.
- Abrasion resistant strong bottom
- Ergonomic heel shaped pattern. Ideal design to avoid baggy fit

# HUNTER SOCKS

3 mm

Very soft and super supple socks made of 3 mm Elastic-Span neoprene. They have a honeycomb reinforcing and anti-slip coating on the sole. The Black-Metallite lining makes them easier to put on.



CAMO BLUE

CODE	SIZE	CASE PACK
USW020201	S	5
USW020202	M	5
USW020203	L	5
USW020204	XL	5

CAMO GREEN

CODE	SIZE	CASE PACK
LX433211	S	5
LX433212	M	5
LX433213	L	5
LX433214	XL	5



## HEX GRIP

Cressi designed a glove that provides high comfort and dexterity while being cut puncture and impact-resistant, making it ideal for Lobstering and Spearfishing. The wrist closer will always keep the glove in place, regardless of normal use expansion from water weight.



BLUE



LIME



BLUE

CODE	SIZE	CASE PACK
PQ100601	XS	10
PQ100602	S	10
PQ100603	M	10
PQ100604	L	10
PQ100605	XL	10
PQ100606	2XL	10

LIME

CODE	SIZE	CASE PACK
PQ100607	XS	10
PQ100608	S	10
PQ100609	M	10
PQ100610	L	10
PQ100611	XL	10
PQ100612	2XL	10

## CONCH DYFIBER

Cressi designed a glove that provides high comfort and dexterity while being cut and puncture resistant, making it ideal for Lobstering and Spearfishing. The wrist closer will always keep the glove in place, regardless of normal use expansion from water weight.



BLUE

CODE	SIZE	CASE PACK
PQ100702	S	10
PQ100703	M	10
PQ100704	L	10
PQ100705	XL	10
PQ100706	2XL	10

LIME

CODE	SIZE	CASE PACK
PQ100708	S	10
PQ100709	M	10
PQ100710	L	10
PQ100711	XL	10
PQ100712	2XL	10

**TECHNICAL FEATURES**

- Cressi's glove materials offer maximum strength with minimum weight.
- High-performance polyethylene and stainless steel
- The sandy nitrile palm provides outstanding grip in dry, wet, and oily conditions.

**4 CUT RESISTANCE LEVEL**  
**3 PUNCTURE RESISTANCE LEVEL**

## HUNTER GLOVES

The Hunter Gloves are 5 fingers gloves made with premium quality Elastic Neoprene. This fabric provides high elasticity and comfort giving the possibility to use the complete movements of the fingers.



CAMO BLUE | 2mm

CODE	SIZE
USW022501	S
USW022502	M
USW022503	L
USW022504	XL

CAMO GREEN | 2mm

CODE	SIZE
LX477901	S
LX477902	M
LX477903	L
LX477904	XL

# BUOYS

## FREEDIVING TRAINING BUOY



Dedicated to freediving lovers. It has a durable external material, an external zipper pocket, 4 external handles for pre-immersion preparation, and 2 exterior D-rings. The wide interior space allows storing the rope during transport. The inner bladder features a valve offering the choice of oral inflation or the use of an inflator hose. The freediving rope can be connected to the underneath stainless steel D-ring. The red diving flag is included to be seen from distance. Made of durable 1050 Denier Cordura fabric.

### TECHNICAL FEATURES

- Outer bag made of 1050 Denier Cordura fabric
- Inner bladder with inflator valve
- 4 TPR lateral handles
- 2 lateral stainless steel D-rings
- Underneath central large stainless steel D-ring for rope connection
- Large storage compartment with Velcro closure

CODE

TA611990

## SIGNAL BOARD BUOY



CODE

TA611902

## TORPEDO PRO BUOY FLOAT



CODE

TA611603

### BUOY'S ACCESSORIES

## HUNTER SWIVEL SNAP CLIP



**DESCRIPTION:**  
The Snap Clip is made in stainless steel to ensure strength. It features a swivel to be knotted to a float line. It is ideal to be mounted on butt of gun for float line connection. It has an ideal size for buoy connections.

CODE

FA390037

## FLOAT ROPE



**DESCRIPTION:**  
Length: 98.5 ft | 30 m, Strength: 330.7 lb | 150 kg.  
Thickness (diameter): 0.24 in | 6 mm, Style of braiding: weave Long rope of 100 ft (approx.) made in strong polyethylene for use as an accessory for freediving or spearfishing. The rope is composed by weaving a group of 16 twists each consisting of 6 thin wires of 0.25mm diameter twisted together.

CODE

TA613530

# PREMIUM MARSEILLAISE RUBBER BELT

The Premium Marseillaise Belts allows the freediver to snug up the belt at the surface and forget it while going deep underwater.



CODE	PRODUCT	CASE PACK
TA626000	Premium Marseillaise Rubber Belt - Black	10
TA626020	Premium Marseillaise Rubber Belt - Blue	10

# NYLON WEIGHT BELT

Strong, woven nylon weight belt with a stainless steel buckle. The quick-release stainless steel buckle provides an instinctive and rapid emergency release. The buckle tab is very strong and is riveted at both ends.



METAL STAINLESS STEEL BUCKLE

HARD PLASTIC BUCKLE

CODE	PRODUCTS	CASE PACK
UW100000	NYLON WEIGHT BELT w/ METAL BUCKLE - BLACK	10
UW100001	NYLON WEIGHT BELT w/ METAL BUCKLE - NEON YELLOW	10
TA627020	NYLON WEIGHT BELT w/ HARD PLASTIC BUCKLE - BLUE	10

# QUICK-RELEASE ELASTIC BELT

The Premium Elastic Rubber Belt is manufactured with a high stretch rubber to keep your weights comfortably in proper position during ascents and descents. The quick-release stainless steel buckle provides instinctive and rapid emergency release.



BLACK

YELLOW

BLUE

CODE	PRODUCT	CASE PACK
TA626010	QUICK-RELEASE ELASTIC BELT w/ METAL BUCKLE - BLACK	10
XTA626011	QUICK-RELEASE ELASTIC BELT w/ METAL BUCKLE - YELLOW	10
XTA626020	QUICK-RELEASE ELASTIC BELT w/ METAL BUCKLE - BLUE	10



# WEIGHT BELT KEEPER

CODE	PRODUCT	CASE PACK
TA627100	Hard Plastic (5 Pack)   Black	10
TA627101	Stainless Steel (2 Pack)   Silver	10
TA627102	D-Ring 26mm Stainless Steel (2 Pack)	10



# WEIGHT BAG LIBRA BALLAST

The Libra is the bag for carrying the ballast needed for your scuba diving equipment. It can carry also the weights used by the freedivers. It is made in strong and resistant Denier fabric, for long-lasting use and for a huge weight. Built rugged, the double webbing encircles the entire bag for added strength and joins to form a padded handle. Double-slider zipper makes it easy to access the main compartment. Personal tag or business card compartment on one side.



### TECHNICAL FEATURES

- Capacity: 14 liters, 0.5 cu ft
- Dimension: 30.5 x 30.5 x 15.2 cm, 12 x 12 x 6 in



CODE	PRODUCT	CASE PACK
UB500550	LIBRA BALLAST WEIGHT BAG - BLACK	3





# BAGS & BACKPACKS

FREEDIVING





# TUNA DRY

WHEELED BAG - FITS LONG BLADE FINIS



## TECHNICAL FEATURES

- Waterproof bag
- Made of Polyester
- External pocket
- Side handles and shoulder straps
- Roller skate wheels

## INSIDE STRAPS



WITH WHEELS



## SEMI RIGID CASE



**120**  
LITERS



BLACK/RED



BLACK/BLUE

It is an ideal bag for transporting any kind of equipment for water activities keeping protected from water. It has a capacity of 120 liters | 4.23 cu ft that can fit also long freediving fins. Made of highly resistant materials, it allows you to keep your equipment dry and protect electronic devices. Equipped with central handles/shoulder straps and side handles to facilitate transport even with the presence of wheels. The presence of wheels facilitates transport even on long routes. Equipped

with practical central handles/shoulder straps and reinforced side handles. A practical waterproof side pocket keeps small items dry and protects electronic devices. Internal straps with clip closure allow you to secure the sports equipment during transport. Made of very resistant materials, with well-finished stitching. The lower part is reinforced, shockproof, and insulating. Waterproof seal. Keep your equipment dry, and protect electronic devices and documents from water, dust, and sand.

CODE	COLOR	CASE PACK
XUB976200	Black/Red	2
XUB976220	Black/Blue	2

TUNA	DIMENSION (LENGTH-WIDTH-HEIGHT)		VOLUME		WEIGHT	
	cm	in	liter	cu ft	kg	lb
	95 x 41 x 40	37 1/2 x 16 x 15 3/4	120	4.23	3.5 kg	7 lb 11 oz



# GORILLA PRO

HEAVY-DUTY WATERPROOF GEAR BAG



2024 - CATALOG

**135**  
LITERS

One large and roomy bag. The bag is long enough to hold even the long freediving fins. It is made from a strong radio frequency (RF) welded seam PVC and is waterproof. Equipment can be washed with water while still inside the bag. Once you have finished washing your gear, the bag has a special draining cap situated at one end to let water out easily and conveniently. Comes with handy top grab carry handles and two straps that can also be used as shoulder straps. No water comes out when transported, even by car.

### TECHNICAL FEATURES

- Made from a strong radio frequency (RF) welded seam PVC
- Waterproof fabric
- Durable straps for carrying any style
- 2 Shoulder straps and handle straps on both ends of the bag
- Draining cap for washing bag and equipment
- Strong YKK zipper
- Front zipped pocket

SPECIAL RELEASE CAP



ZIPPED EXTERNAL POCKET



BLACK



CAMO BLUE



CAMO GREY

CODE	COLOR	CASE PACK
UA925710	Black	10
XUA925798	Camo Blue	10
XUA925799	Camo Grey	10

GORILLA PRO	DIMENSION (LENGTH-WIDTH-HEIGHT)		VOLUME		WEIGHT	
	cm	in	liter	cu ft	kg	lb
	95 x 34 x 42	37 x 13 x 16	135	4.77	1.5 kg	3.5 lb 5 oz

CRESSI

# PIOVRA DRY

## LONG BLADE FINS BACKPACK

NEW  
2024



**85**  
LITERS



It is a perfect backpack for freediving and spearfishing equipment. It is made of water-repellent material, even if not watertight. The main compartment, with breathable anti-moisture mesh at the bottom, can accommodate freediving gear, such as a wetsuit, long fins (up to 100 cm · 39 1/4 in), mask, mouthpiece, belt, knife, and various accessories. The secondary compartment, i.e. the outside pocket, is a "cooler" type refrigerator bag for the transport of cold drinks or fish. The external elastic with braided laces allows to insertion of other objects, such as the towel. The two sides are equipped with fixing systems for two spearguns. There is a D-ring at the top of the bag. The two carrying straps are adjustable and a side handle makes it easier to grip. A reflective print on the front ensures greater visibility. The main compartment has eyelets for the padlock.

### TECHNICAL FEATURES

- Waterproof coating
- Front "cooler" pocket
- Long fins compartment
- Side speargun holder
- Adjustable padded shoulder straps



CODE CASE PACK  
XVB990250 10

PIOVRA DRY	DIMENSION (LENGTH-WIDTH-HEIGHT)		VOLUME		WEIGHT	
	cm	in	liter	cu ft	kg	lb
	30 x 30 x 130	11 2/4 x 11 3/4 x 44	85	3.00	1.6 kg	3 lb 8 oz

# DRY GARA

HIGH-VOLUME AND RESISTANT DRY BACKPACK



**60**  
LITERS

2024 - CATALOG



The Dry Gara Backpack is waterproof, ideal for carrying your equipment comfortably. It is made of durable PVC laminated Tarpaulin heat-sealed by high frequency of 5 tenths of a thickness: almost 100% watertight and, therefore, very practical not to wet the boot of the vehicle.

Adjustable anatomical shoulder straps, with 40 mm straps, adjustable chest strap, and waist strap. Heat-sealed padding. Capacity of 60 liters, ideal for complete equipment adding, also, the longest fins for diving or apnea. Two straps on each side that allow the transport of two spearguns.

## TECHNICAL FEATURES

- Ideal for Gara fins
- High-frequency welding
- 2x gun holder
- 100% Dry Bags

### FOLDING

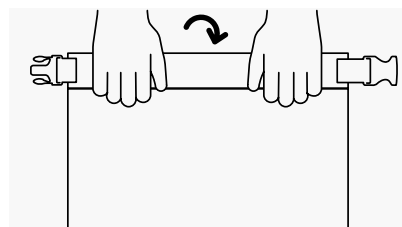

### 2 X GUN-HOLDER

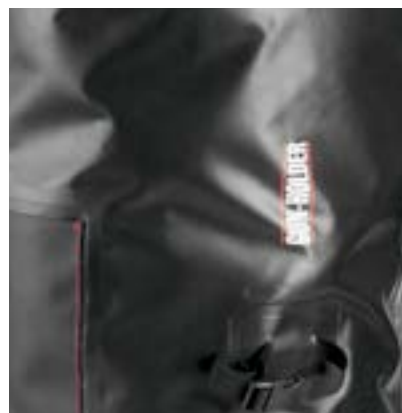

CODE	SIZE	CASE PACK
UA925800	60 liters	10

DRY GARA	DIMENSION (LENGTH-WIDTH-HEIGHT)		VOLUME		WEIGHT	
	cm	in	liter	cu ft	kg	lb
	39.5 x 23.5 x 66	15 x 9 x 26	60	2.12	1.12 kg	2 lb 7.5 oz

CRESSI



# GARA PREMIUM BAG



A newly renovated version of the Gara Bag. The unique and functional bag with the necessary space to store fins, mask and snorkel. The famous Gara fins, the long freediving fins, can be accommodated easily in this shoulder bag for comfortable and secure transportation.

The bottom part is made with a strong mesh which allows water to drain. Practical front pocket with zip closure for storing personal stuff. It features a padded adjustable shoulder strap.

## TECHNICAL FEATURES

- Nylon 600 denier
- Front pocket

CODE	CASE PACK
UB931081	5

# LONG FIN SET BAG



The Long Fins Set Bag is a functional bag with the necessary space to store fins, mask and snorkel. Also longer fins such as Gara are accommodated easily in this shoulder bag for comfortable and secure transportation. Bag is made from durable nylon material.

## TECHNICAL FEATURES

- Nylon 600 denier
- Front plastic window

CODE
US451031

## LONG FIN SET BAG

### DIMENSION (LENGTH-WIDTH-HEIGHT)

cm	in
175 x 24.5 x 94	6.9 x 9.6 x 37



## CRESSI SPEARFISHING NEW COLLECTION

With this catalogue, we would like to highlight our origins, which have distinguished us over the years. Today, with the same passion as then, we follow the needs of our customers, from the beginners to the most ambitious athletes, sure of providing products suitable for all needs, always focusing on technology and results.

In these 76 years the company has always preserved its DNA, which is well represented by Cressi logo. The "C" logo with the mermaid, in the origin with the speargun, is recognisable all over the world as a prestigious brand of watersports and spearfishing.

Our goal is to provide a complete vision of our products Dedicated to all those who make spearfishing their passion. The work undertaken over the years carries out a constant renewal of products with strict testing and always new technologies, placing us at the top for reliability, performance and durability. All this takes in thanks to a continuous dialogue between our designers, who are always ready to make the best improvements, and our ambassadors, expert testers who have made the sea their home.

**CRESSI**





# SPEARFISHING



***BORN  
FROM  
THE SEA***



# VICTORY NEW 2024

FOR BIG GAME SPEARFISHING



31 mm BARREL

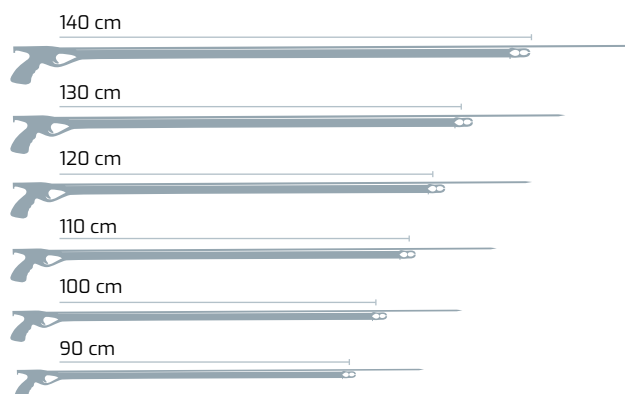

**TECHNICAL FEATURES**

- Control and precision
- Exceptional hydrodynamics
- Adaptability
- Shaft  $\varnothing$  mm 7.5 with bottom flopper
- Triple elastic circular band  $\varnothing$  mm 14 with Dyneema SK78 wishbone



HYDRA  $\varnothing$  7.5 mm TRIPLE FINNED SHAFT W/ BOTTOM FLOPPER



TRIPLE MOUNT CLOSED MUZZLE



TRIPLE  $\varnothing$  14 mm CIRCULAR BAND



31 mm RIGID AND HYDRODYNAMIC ROUND BARREL



SPECIAL ANGLED HANDLE TO INCREASE THE SHOOTING ACCURACY

The Cressi Victory fishing rifle is the ideal choice for fishing enthusiasts looking for a superior experience. With its excellent rebound control and great shooting accuracy, the Victory guarantees more effective and rewarding fishing.

What makes the Victory rifle different from others is its 31 mm round body; despite its rigidity, it offers exceptional hydrodynamics in all directions. This allows smooth and fast movements in the water,

enabling the angler to move nimbly and easily to reach the best position and hit the target with precision.

The result is a durable speargun that delivers exceptional performance, allowing the angler to meet challenges in the water with ease and precision. In summary, the Cressi Victory bungee speargun is a high-quality option for those wishing to enhance their fishing experience.

CODE	SIZE	CASE PACK
FE380090	90 cm	6
FE380100	100 cm	6
FE380110	110 cm	6
FE380120	120 cm	6
FE380130	130 cm	6
FE380140	140 cm	6



# CHEROKEE POWER

UNLIMITED POWER

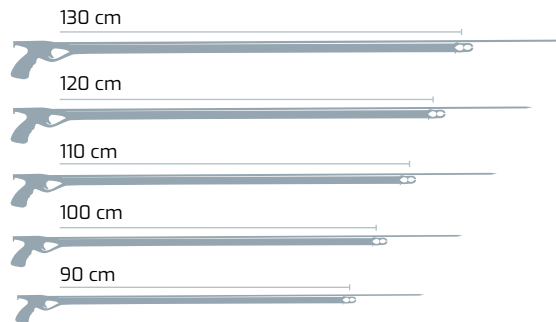

Anticorodal black frame with integrated spear guide, grip made of engineering plastic reinforced with glass fibre, interchangeable high or low soft sternal support. Ultra-light triggering case with trigger, release mechanism and line ring on the side in AISI 316, machined from solid with a CNC process. The shock absorber makes silent the release of the shaft. Reversible side-safety mechanism. Reinforced reel with steel pin buckle.

Head for double elastic with magnetic spear lock: as soon as the spear is put in place, it is held by two magnets mounted in a watertight chamber. This characteristic guarantees maximum speed of reset without the disadvantages of conventional mechanical restraint systems. The speargun is supplied with double 16 mm natural latex band, with Dyneema wishbone.

CODE	SIZE	CASE PACK
FE365200	90 cm	6
FE365300	100 cm	6
FE365400	110 cm	6
FE365500	120 cm	6
FE365600	130 cm	6
FE365700	140 cm	6

## ACCESSORIES

CODE	PRODUCT
FA359050	REEL R50
FA359030	REEL R30

## SPARE PARTS

CODE	PRODUCT	SIZE
FA406120	KRAKEN Ø 7mm BT. FLOPPER (120 cm) [GUN 90]	120 cm
FA406130	KRAKEN Ø 7mm BT. FLOPPER (130 cm) [GUN 100]	130 cm
FA406140	KRAKEN Ø 7mm BT. FLOPPER (140 cm) [GUN 110]	140 cm
FA406150	KRAKEN Ø 7mm BT. FLOPPER (150 cm) [GUN 120]	150 cm
FA406160	KRAKEN Ø 7mm BT. FLOPPER (160 cm) [GUN 120]	160 cm
FA400525	CIRCULAR BAND w/LW Ø 16mm ID3.2mm - BLUE [63cm] (GUN 100)	63 cm
FA400526	CIRCULAR BAND w/LW Ø 16mm ID3.2mm - BLUE [69cm] (GUN 110)	69 cm
FA400527	CIRCULAR BAND w/LW Ø 16mm ID3.2mm - BLUE [77cm] (GUN 120)	77 cm
FA400528	CIRCULAR BAND w/LW Ø 16mm ID3.2mm - BLUE [81cm] (GUN 130)	81 cm
FB1532162	BAND RUBBER TUBING 50FT - BLUE - Ø 16mm - ØID 3.2	50 ft

## TECHNICAL FEATURES

- Ultra light release box and trigger
- Lateral guide line release with automatic return
- Interchangeable high-low sternal support
- Shaft Ø 7 mm with tig welded and drilled fins and reversed flopper
- Quick loading magnetic open muzzle
- Double circular band Ø 16 mm with a 2 mm lined wishbone
- Rigged barrel Ø 28 mm with shaft guide



SHAFT Ø 7 mm



QUICK LOADING MAGNETIC OPEN MUZZLE



DOUBLE Ø 16 mm CIRCULAR BAND WITH Ø 2 mm LINED WISHBONE



SHOCK ABSORBER



INTERCHANGEABLE HIGH-LOW SUPPORT



RUGGED AND REINFORCED BARREL WITH SHAFT GUIDE



SPECIAL ANGLED HANDLE TO INCREASE SHOOTING ACCURACY

# CHEROKEE FAST

POWERFUL WITH EASY LOADING

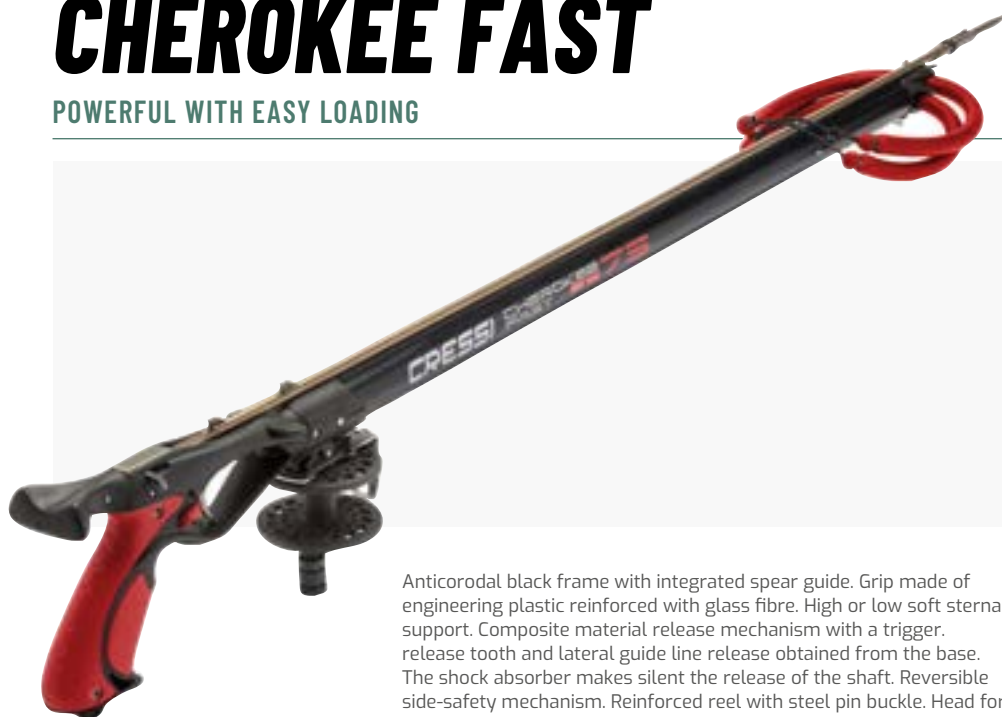

Anticorodal black frame with integrated spear guide. Grip made of engineering plastic reinforced with glass fibre. High or low soft sternal support. Composite material release mechanism with a trigger. release tooth and lateral guide line release obtained from the base. The shock absorber makes silent the release of the shaft. Reversible side-safety mechanism. Reinforced reel with steel pin buckle. Head for double elastic with magnetic spear lock: as soon as the spear is put in place. It is held by two magnets mounted in a watertight chamber. This characteristic guarantees maximum speed of reset without the disadvantages of conventional mechanical restraint systems.

## TECHNICAL FEATURES

- Anticorodal black barrel with integrated spear guide
- Handle made of engineering plastic reinforced with fiberglass
- Adjustable ergonomic handle, two screws allow you to set a larger or smaller handle
- Sideline release integrated into the body of the gun.
- Cobra design open-muzzle featuring softer angles for reducing friction with the bands
- Muzzle with the spear-lock system: two magnets hold the shaft in position
- Shock absorber for silencing the release of the shaft
- Reel included featuring a quick-release mounting bracket
- Choice between two sternal supports, one long and one short
- Supplied assembled, ready for use.



FINNED BOTTOM FLOPPER SHAFT Ø 6.5 mm



QUICK LOADING MAGNETIC OPEN MUZZLE



DOUBLE Ø 14 mm CIRCULAR BAND WITH Ø 2 mm LINED WISHBONE



SHOCK ABSORBER

INTERCHANGEABLE HIGH-LOW SUPPORT



28 mm

RUGGED AND REINFORCED BARREL WITH SHAFT GUIDE



ULTRA LIGHT HANDLE, RELEASE BOX AND TRIGGER. LATERAL GUIDE LINE RELEASE WITH AUTOMATIC RETURN

2024 - CATALOG

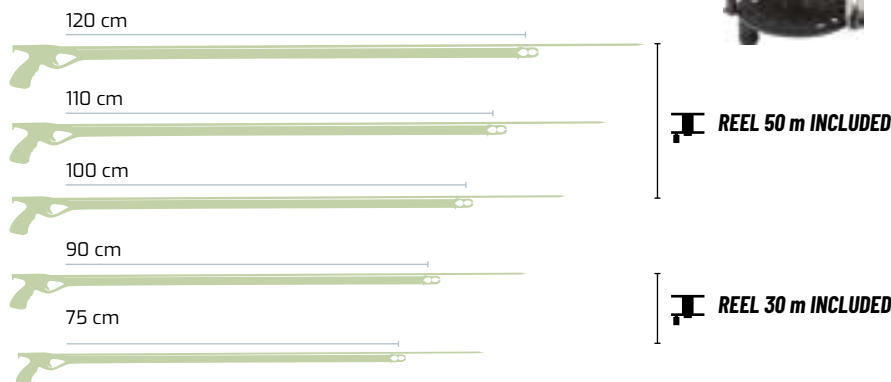

CODE	SIZE	CASE PACK
FE363100	75 cm	6
FE363200	90 cm	6
FE363300	100 cm	6
FE363400	110 cm	6
FE363500	120 cm	6







SPARE PARTS

CODE	PRODUCT
FA404903	INOX FINNED SHAFT Ø 6.5mm BT. FLOPPER (105 cm)
FA404904	INOX FINNED SHAFT Ø 6.5mm BT. FLOPPER (120 cm)
FA404905	INOX FINNED SHAFT Ø 6.5mm BT. FLOPPER (130 cm)
FA404906	INOX FINNED SHAFT Ø 6.5mm BT. FLOPPER (140 cm)
FA404907	INOX FINNED SHAFT Ø 6.5mm BT. FLOPPER (150 cm)
FA400483	CIRCULAR BAND w/LW Ø 14mm ID3.2mm - RED (48cm) (GUN 75)
FA400484	CIRCULAR BAND w/LW Ø 14mm ID3.2mm - RED (57cm) (GUN 90)
FA400485	CIRCULAR BAND w/LW Ø 14mm ID3.2mm - RED (63cm) (GUN 100)
FA400486	CIRCULAR BAND w/LW Ø 14mm ID3.2mm - RED (69cm) (GUN 110)
FA400487	CIRCULAR BAND w/LW Ø 14mm ID3.2mm - RED (77cm) (GUN 120)
FB1516168	BAND RUBBER TUBING 50FT - RED - Ø 16mm - ØID 1.6



# CHEROKEE EXO

## MODULAR POWER



Anticorodal black frame with integrated spear guide, grip made of engineering plastic reinforced with glass fibre, high or low soft sternal support. Ultra-light triggering case with trigger, release mechanism and line ring on the side in AISI 316, machined from solid with a CNC process. The shock absorber makes silent the release of the shaft. Reversible side-safety mechanism. Reinforced reel with steel pin buckle. Head for double elastic with magnetic spear lock: as soon as the spear is put in place, it is held by two magnets mounted in a watertight chamber. This characteristic guarantees maximum speed of reset without the disadvantages of conventional mechanical restraint systems. The speargun is supplied with a 16 mm natural latex elastic, with Dyneema wishbone.

### TECHNICAL FEATURES

- Anticorodal black barrel with integrated spear guide.
- Handle made of engineering plastic reinforced with fiberglass.
- Adjustable ergonomic handle, two screws allow you to set a larger or smaller handle.
- Sideline integrated into the body of the gun.
- Cobra design open-muzzle featuring softer angles for reducing friction with the bands.
- Muzzle with the spear-lock system: two magnets hold the shaft in position.
- Interchangeable high-low sternal support.
- Dovetail mounting for additional reel (not included).
- Supplied assembled, ready for use.



SHAFT Ø 6.5 mm



QUICK LOADING MAGNETIC OPEN MUZZLE



Ø 16 mm CIRCULAR BAND WITH Ø 2 mm LINED WISHBONE



RUGGED AND REINFORCED BARREL WITH SHAFT GUIDE



INTERCHANGEABLE HIGH-LOW STERNAL SUPPORT



ULTRA LIGHT HANDLE, RELEASE BOX AND TRIGGER. LATERAL GUIDE LINE RELEASE WITH AUTOMATIC RETURN

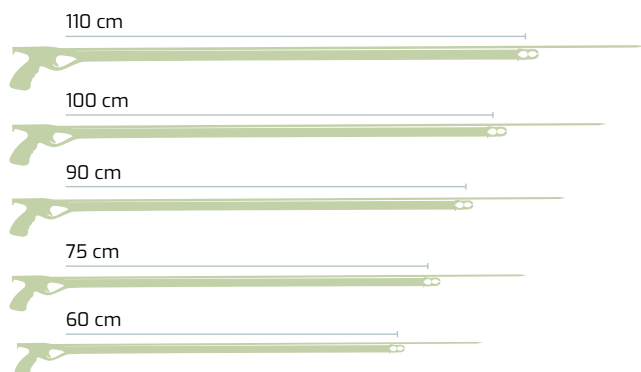

CODE	SIZE	CASE PACK
FE364000	60 cm	6
FE364100	75 cm	6
FE364200	90 cm	6
FE364300	100 cm	6
FE364400	110 cm	6







ACCESSORIES

CODE	PRODUCT
FA359050	REEL R50
FA359030	REEL R30

SPARE PARTS

CODE	PRODUCT	GUN LENGTH
FA404902	INOX FINNED SHAFT Ø 6.5mm BT. FLOPPER (90 cm)	60 cm
FA404903	INOX FINNED SHAFT Ø 6.5mm BT. FLOPPER (105 cm)	75 cm
FA404904	INOX FINNED SHAFT Ø 6.5mm BT. FLOPPER (120 cm)	90 cm
FA404905	INOX FINNED SHAFT Ø 6.5mm BT. FLOPPER (130 cm)	100 cm
FA404906	INOX FINNED SHAFT Ø 6.5mm BT. FLOPPER (140 cm)	110 cm
FA400562	CIRCULAR BAND w/LW Ø 16mm ID3.2mm - LIME (39cm) (GUN 60)	60 cm
FA400563	CIRCULAR BAND w/LW Ø 16mm ID3.2mm - LIME (48cm) (GUN 75)	75 cm
FA400564	CIRCULAR BAND w/LW Ø 16mm ID3.2mm - LIME (57cm) (GUN 90)	90 cm
FA400565	CIRCULAR BAND w/LW Ø 16mm ID3.2mm - LIME (63cm) (GUN 100)	100 cm
FA400566	CIRCULAR BAND w/LW Ø 16mm ID3.2mm - LIME (69cm) (GUN 110)	110 cm



CRESSI



# YUMA FAST

THE GUN FOR AMBUSH AND DEN



Anticorrosive black frame with integrated spear guide, grip made of engineering plastic reinforced with glass fiber, integrated soft sternal support. Ultra-light triggering case with a release mechanism in AISI 316. Dovetail reel coupling. Head for double elastic with magnetic spear lock: as soon as the spear is put in place, it is held by two magnets mounted in a watertight chamber. This characteristic guarantees maximum speed of reset without the disadvantages of conventional mechanical restraint systems. The speargun is supplied with a double 14 mm natural latex band, with a Dyneema wishbone.

## TECHNICAL FEATURES

- Guide line release with automatic return
- Integrated sternal support
- Shaft  $\varnothing$  mm 6 with tig welded fins and reversed flopper
- Quick loading magnetic open muzzle
- Circular band  $\varnothing$  mm 14 with lined wishbone 2 mm
- Rigged barrel  $\varnothing$  mm 26 with shaft guide



FINNED BOTTOM FLOPPER  $\varnothing$  6 mm SHAFT



QUICK LOADING MAGNETIC OPEN MUZZLE



$\varnothing$  14 mm CIRCULAR BAND



SHOCK ABSORBER

RUGGED AND REINFORCED BARREL WITH SHAFT GUIDE



SPECIAL ANGLED HANDLE TO INCREASE SHOOTING ACCURACY

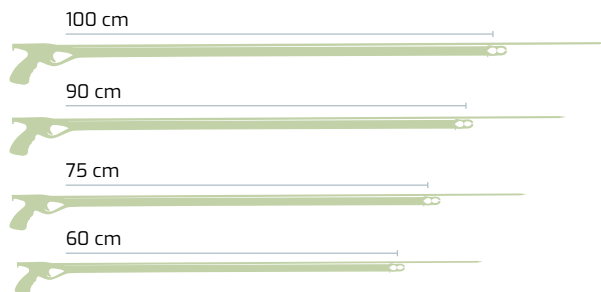

CODE	SIZE	CASE PACK
FE349000	60 cm	6
FE349100	75 cm	6
FE349200	90 cm	6
FE349300	100 cm	6





SPARE PARTS

CODE	PRODUCT	GUN LENGTH
FA407090	INOX FINNED SHAFT Ø 6mm BT. FLOPPER (90 cm)	60 cm
FA407105	INOX FINNED SHAFT Ø 6mm BT. FLOPPER (105 cm)	75 cm
FA407120	INOX FINNED SHAFT Ø 6mm BT. FLOPPER (120 cm)	90 cm
FA407130	INOX FINNED SHAFT Ø 6mm BT. FLOPPER (130 cm)	100 cm
FA400483	CIRCULAR BAND w/LW Ø 14mm ID3.2mm - RED (48cm) (GUN 75)	120 cm
FA400484	CIRCULAR BAND w/LW Ø 14mm ID3.2mm - RED (57cm) (GUN 90)	120 cm
FA400485	CIRCULAR BAND w/LW Ø 14mm ID3.2mm - RED (63cm) (GUN 100)	120 cm
FA400486	CIRCULAR BAND w/LW Ø 14mm ID3.2mm - RED (69cm) (GUN 110)	120 cm
FA400487	CIRCULAR BAND w/LW Ø 14mm ID3.2mm - RED (77cm) (GUN 120)	120 cm
FB1532148	BAND RUBBER TUBING 50FT - RED - Ø 14mm - ØID 3.2	





# COMANCHE RAIL

## THE HISTORY OF OUR SPEARGUNS

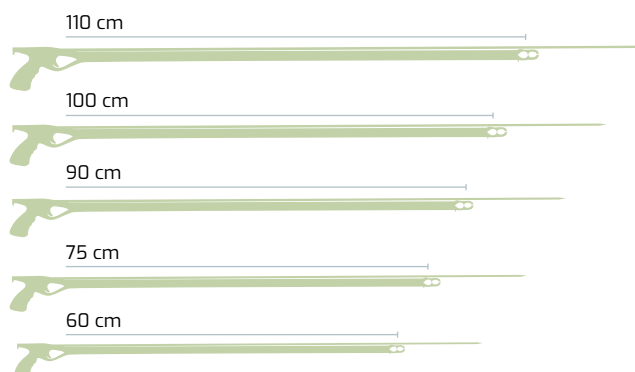

The Comanche Rail is the latest version of Cressi's world champion spear gun. The high-strength, anti-corrosion aluminum barrel now features an integrated guide rail for increased accuracy. The high-tech and lightweight modern thermoplastic hand grip and muzzle guarantee the utmost maneuverability in the water, adding to the Comanche Rail's accuracy. The compact and hydrodynamic muzzle makes it possible to add a second lower band to increase power for larger prey. The muzzle and handgrip are

configured so the shooter can easily acquire a sight picture of the gun while simultaneously tracking their target. The Comanche Rail comes with a heat-treated 6.0 mm spring stainless steel 17-4 PH notched shaft, 16 mm parallel power bands, metal articulated wishbone, and a shaft rigged to the gun with a 1.4 mm braided multifilament line rated to 80 kg / 176 lb. The Comanche Rail also features a dovetail notch in front of the trigger guard, allowing a reel to be mounted.

### TECHNICAL FEATURES

- Anti-corrosion aluminum barrel with a shaft guide
- Lightweight angled handle to increase shot's precision
- Hydrodynamic closed muzzle
- Dovetail notch for reel assembling



Ø 6 mm NOTCHED TOP FLOPPER SHAFT



ULTRA COMPACT CLOSED MUZZLE  
QUICKLOAD MINI SPEARHEAD



Ø 16 mm PARALLEL BAND



RUGGED BARREL WITH SHAFT GUIDE



SPECIAL ANGLED HANDLE TO INCREASE SHOOTING  
ACCURACY

CODE	SIZE	CASE PACK
FE359000	60 cm	6
FE359100	75 cm	6
FE359200	90 cm	6
FE359300	100 cm	6
FE359400	110 cm	6

#### ACCESSORIES

CODE	PRODUCT
FA359050	REEL R50
FA359030	REEL R30

#### SPARE PARTS

CODE	PRODUCT	GUN LENGTH
FA410002	INOX NOTCHED SHAFT Ø 6mm (90cm)	60 cm
FA410003	INOX NOTCHED SHAFT Ø 6mm (105cm)	75 cm
FA410004	INOX NOTCHED SHAFT Ø 6mm (115cm)	90 cm
FA410005	INOX NOTCHED SHAFT Ø 6mm (125cm)	100 cm
FA410006	INOX NOTCHED SHAFT Ø 6mm (130cm)	110 cm
FA400002	PARALLEL BAND Ø 16mm (16cm)	60 cm
FA400003	PARALLEL BAND Ø 16mm (18.5cm)	75 cm
FA400004	PARALLEL BAND Ø 16mm (20cm)	85 cm
FA400005	PARALLEL BAND Ø 16mm (22cm)	90 cm
FA400006	PARALLEL BAND Ø 16mm (25.5cm)	100 cm
FA400007	PARALLEL BAND Ø 16mm (27.5cm)	110 cm





# APACHE

ROBUST AND MINIMALIST

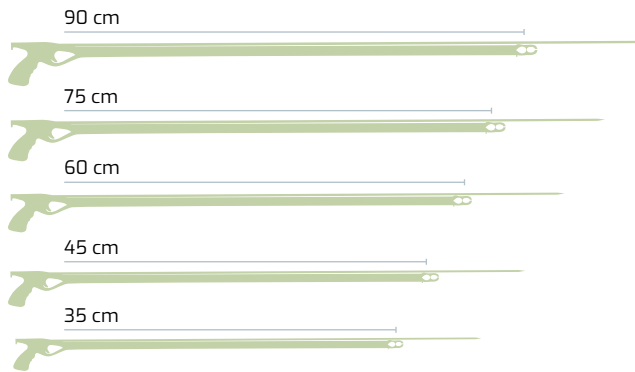

Apache is Cressi's entry level speargun and can also be handily used as a second gun. This gun is an excellent choice when fishing in holes, around rocks, shallows and where the target is in close proximity. The Apache incorporates a closed muzzle, which helps with ease of loading and improved accuracy. The sealed barrel is anodized for enhanced corrosion

resistance, while the ergonomic molded handle permits easier maneuverability and quick muzzle pointing.

The power band is fitted with a standard stainless wishbone and the gun includes the widely preferred Tahitian style flopper shaft.

## TECHNICAL FEATURES

- Ergonomic molded handle for easier maneuverability
- Durable anodized heavy duty sealed aluminum barrel
- Closed muzzle for improved accuracy and ease of loading
- Advanced Tahitian-style flopper shaft for superior penetration
- Replaceable band and wishbone assembly is user friendly

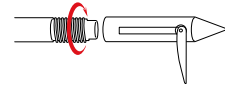

NEW THREADED TIP

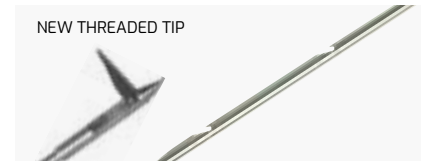

NOTCHED Ø 7 mm THREADED SHAFT



CLOSED MUZZLE WITH SHAFT GUIDE



Ø 13 mm CIRCULAR BAND WITH METAL WISHBONE



Ø 26 mm BARREL



SPECIAL ANGLED HANDLE TO INCREASE SHOOTING ACCURACY

CODE	SIZE	CASE PACK
FE341035	35 cm	6
FE341045	45 cm	6
FE341060	60 cm	6
FE341075	75 cm	6
FE341090	90 cm	6

### SPARE PARTS

CODE	PRODUCT
FA350535	STEEL NOTCHED THREADED SHAFT Ø 7.0 mm [65 cm]
FA350545	STEEL NOTCHED THREADED SHAFT Ø 7.0 mm [75 cm]
FA350560	STEEL NOTCHED THREADED SHAFT Ø 7.0 mm [90cm]
FA350575	STEEL NOTCHED THREADED SHAFT Ø 7.0 mm [105 cm]
FA350590	STEEL NOTCHED THREADED SHAFT Ø 7.0 mm [115 cm]
FA340019	CIRCULAR BAND Ø 13 mm [24 cm] GUN 35
FA340020	CIRCULAR BAND Ø 13 mm [31 cm] GUN 45
FA340021	CIRCULAR BAND Ø 13 mm [34 cm] GUN 60
FA340022	CIRCULAR BAND Ø 13 mm [39 cm] GUN 75
FA340023	CIRCULAR BAND Ø 13 mm [44 cm] GUN 90
FA390002	INOX SPEAR HEAD MONO-FLOPPER ø 6.5mm THREAD
FA350020	JOINTED WISHBONE TYPE A



**HYDRA** NEW 2024

## SLING GUN SHAFT: 17-4 PH FINNED BOTTOM FLOPPER Ø 7.5 mm



CODE	SIZE	CASE PACK
FA421702	90 cm	6
FA421703	100 cm	6
FA421704	110 cm	6
FA421705	120 cm	6
FA421706	130 cm	6
FA421707	140 cm	6

**KRAKEN**

## 17-4 PH FINNED BOTTOM FLOPPER

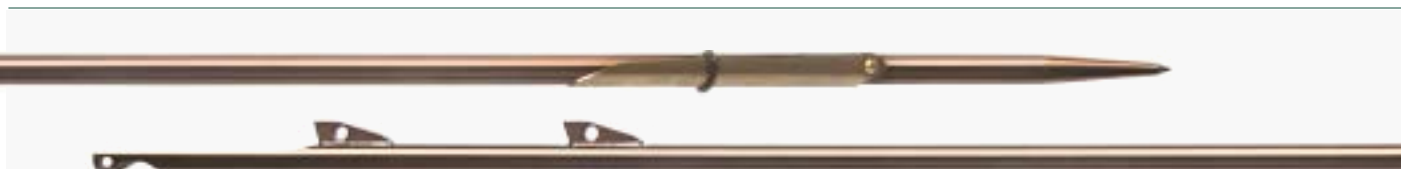

## 17-4 PH FINNED SHAFT Ø 7 mm

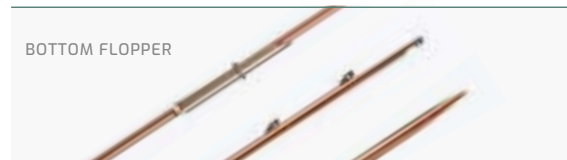

BOTTOM FLOPPER

CODE	SIZE	CASE PACK
FA406120	120 cm	6
FA406130	130 cm	6
FA406140	140 cm	6
FA406150	150 cm	6
FA406160	160 cm	6

## 17-4 PH FINNED SHAFT Ø 6.5 mm



BOTTOM FLOPPER

CODE	SIZE	CASE PACK
FA404902	90 cm	6
FA404903	105 cm	6
FA404904	120 cm	6
FA404905	130 cm	6
FA404906	140 cm	6
FA404907	150 cm	6

## 17-4 PH FINNED SHAFT Ø 6 mm



BOTTOM FLOPPER

CODE	SIZE	CASE PACK
FA407090	90 cm	6
FA407105	105 cm	6
FA407120	120 cm	6
FA407130	130 cm	6

**VERDESCA**

## PR80 NOTCHED TOP FLOPPER Ø 6.5 mm



CODE	SIZE	CASE PACK
FA340000	65 cm	6
FA340001	75 cm	6
FA340002	90 cm	6
FA340003	105 cm	6

## STEEL NOTCHED THREADED SHAFT Ø 7 mm

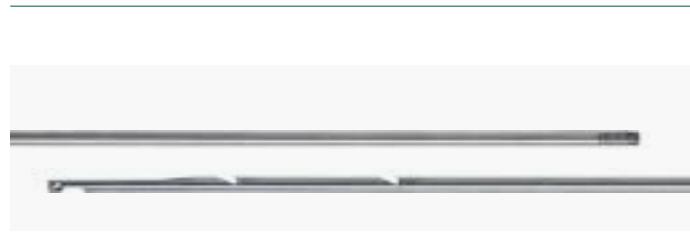

CODE	SIZE	CASE PACK
FA350535	65 cm	6
FA350545	75 cm	6
FA350560	90 cm	6
FA350575	105 cm	6
FA350590	115 cm	6

# BARRACUDA

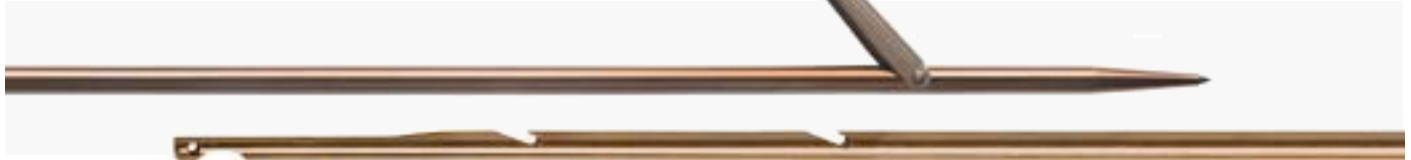

## 17-4 PH NOTCHED SHAFT Ø 6.5 mm

CODE	SIZE	CASE PACK
FA410501	75 cm	6
FA410502	90 cm	6
FA410503	105 cm	6
FA410504	115 cm	6
FA410505	125 cm	6
FA410506	130 cm	6
FA410507	140 cm	6
FA410508	150 cm	6

## 17-4 PH NOTCHED SHAFT Ø 6 mm

CODE	SIZE	CASE PACK
FA410002	90 cm	6
FA410003	105 cm	6
FA410004	115 cm	6
FA410005	125 cm	6
FA410006	130 cm	6
FA410007	140 cm	6
FA410008	150 cm	6

# INOX FINNED THREADED

## SHAFT Ø 7 mm



CODE	SIZE	CASE PACK
FA405203	115 cm	6
FA405204	130 cm	6
FA405205	140 cm	6
FA405206	150 cm	6
FA405207	160 cm	6

## CONVERSION CHART

INCHES > MILLIMETERS : Multiply by **25.4**  
 INCHES > CENTIMETERS : Multiply by **2.54**  
 FEET > METERS : Multiply by **0.3048**  
 POUNDS > GRAMS : Multiply by **454**

in	15/64"	9/32"	5/16"	15/32"	1/2"	9/16"	5/8"	3/4"
mm	6	7	8	12	13	14	16	19

in	13.77	15.74	17.71	21.65	23.62	27.55	29.52	33.46	35.43	37.40	39.37	41.33	43.30	45.27	47.24
cm	35	40	45	55	60	70	75	85	90	95	100	105	110	115	120



## SLIP TIP + FLOPPER + RETAINER

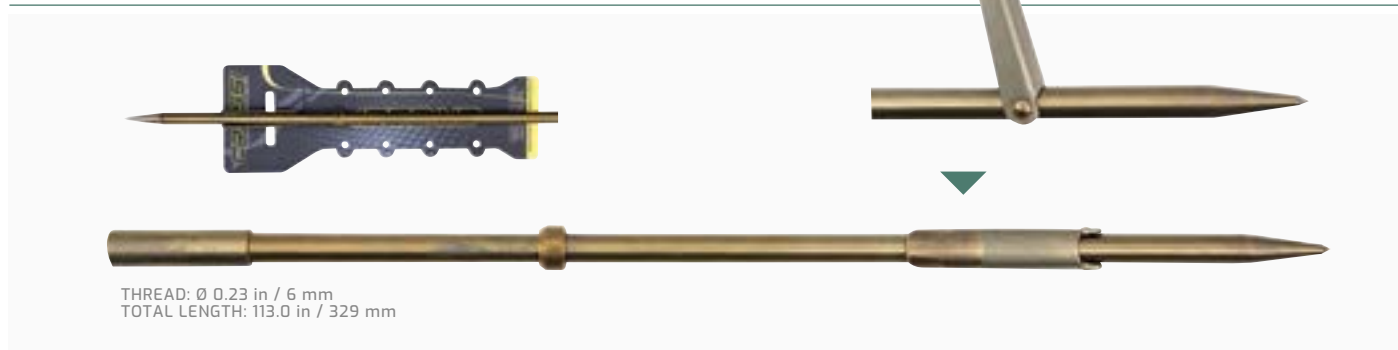

THREAD: Ø 0.23 in / 6 mm  
TOTAL LENGTH: 113.0 in / 329 mm

DESCRIPTION: The Slip Tip has a Flopper and a Retainer. Designed with a Tahitian Style Point. It is made of stainless steel 17-4 PH H900 heat treatment.

CODE	PRODUCT	CASE PACK
USX021100	SLIP TIP 6 mm + FLOPPER - THREAD - 17-4 PH + CABLE 2 mm	10

## INOX SPEAR HEAD MONO-FLOPPER



CODE	PRODUCT
FA390002	INOX SPEAR HEAD MONO-FLOPPER ø 6.5mm THREAD





# RUBBER BAND TUBING

50 ft

DESCRIPTION: Reinforced internal tube, bigger density (shore 45<sup>o</sup>) to maximize the resistance to pressure of the ball over the internal walls of the rubber.

CODE	COLOR	SIZE	STYLE	CASE PACK
FB1516142	Blue	50 ft   15 m	Ø 14mm - ØID 1.6	1
FB1516145	Black	50 ft   15 m	Ø 14mm - ØID 1.6	1
FB1516148	Red	50 ft   15 m	Ø 14mm - ØID 1.6	1
FB1516162	Blue	50 ft   15 m	Ø 16mm - ØID 1.6	1
FB1516165	Black	50 ft   15 m	Ø 16mm - ØID 1.6	1
FB1516168	Red	50 ft   15 m	Ø 16mm - ØID 1.6	1
FB1532142	Blue	50 ft   15 m	Ø 14mm - ØID 3.2	1
FB1532145	Black	50 ft   15 m	Ø 14mm - ØID 3.2	1
FB1532148	Red	50 ft   15 m	Ø 14mm - ØID 3.2	1
FB1532162	Blue	50 ft   15 m	Ø 16mm - ØID 3.2	1
FB1532165	Black	50 ft   15 m	Ø 16mm - ØID 3.2	1
FB1532168	Red	50 ft   15 m	Ø 16mm - ØID 3.2	1
FB1532182	Blue	50 ft   15 m	Ø 18mm - ØID 3.2	1
FB1532185	Black	50 ft   15 m	Ø 18mm - ØID 3.2	1
FB1532188	Red	50 ft   15 m	Ø 18mm - ØID 3.2	1

# CIRCULAR BAND

W / LW Ø 16 mm | Ø 14 mm



CODE	COLOR	SIZE	STYLE
<b>NEW</b> FA400522	Blue	39 cm	Ø 16 mm ID 3.2 mm
<b>NEW</b> FA400523	Blue	48 cm	Ø 16 mm ID 3.2 mm
FA400524	Blue	57 cm	Ø 16 mm ID 3.2 mm
FA400525	Blue	63 cm	Ø 16 mm ID 3.2 mm
FA400526	Blue	69 cm	Ø 16 mm ID 3.2 mm
FA400527	Blue	77 cm	Ø 16 mm ID 3.2 mm
FA400528	Blue	81 cm	Ø 16 mm ID 3.2 mm
<b>NEW</b> FA400552	Black	39 cm	Ø 16 mm ID 3.2 mm
<b>NEW</b> FA400553	Black	48 cm	Ø 16 mm ID 3.2 mm
<b>NEW</b> FA400554	Black	57 cm	Ø 16 mm ID 3.2 mm
<b>NEW</b> FA400555	Black	63 cm	Ø 16 mm ID 3.2 mm
<b>NEW</b> FA400556	Black	69 cm	Ø 16 mm ID 3.2 mm
<b>NEW</b> FA400557	Black	77 cm	Ø 16 mm ID 3.2 mm
<b>NEW</b> FA400558	Black	81 cm	Ø 16 mm ID 3.2 mm
FA400562	Lime	39 cm	Ø 16 mm ID 3.2 mm
FA400563	Lime	48 cm	Ø 16 mm ID 3.2 mm
FA400564	Lime	57 cm	Ø 16 mm ID 3.2 mm
FA400565	Lime	63 cm	Ø 16 mm ID 3.2 mm
FA400566	Lime	69 cm	Ø 16 mm ID 3.2 mm
<b>NEW</b> FA400567	Lime	77 cm	Ø 16 mm ID 3.2 mm
<b>NEW</b> FA400568	Lime	81 cm	Ø 16 mm ID 3.2 mm
<b>NEW</b> FA400422	Blue	39 cm	Ø 14 mm ID 3.2 mm
<b>NEW</b> FA400423	Blue	48 cm	Ø 14 mm ID 3.2 mm
<b>NEW</b> FA400424	Blue	57 cm	Ø 14 mm ID 3.2 mm
<b>NEW</b> FA400425	Blue	63 cm	Ø 14 mm ID 3.2 mm
<b>NEW</b> FA400426	Blue	69 cm	Ø 14 mm ID 3.2 mm
<b>NEW</b> FA400427	Blue	77 cm	Ø 14 mm ID 3.2 mm
<b>NEW</b> FA400428	Blue	81 cm	Ø 14 mm ID 3.2 mm
<b>NEW</b> FA400452	Black	39 cm	Ø 14 mm ID 3.2 mm
<b>NEW</b> FA400453	Black	48 cm	Ø 14 mm ID 3.2 mm
<b>NEW</b> FA400454	Black	57 cm	Ø 14 mm ID 3.2 mm
<b>NEW</b> FA400455	Black	63 cm	Ø 14 mm ID 3.2 mm
<b>NEW</b> FA400456	Black	69 cm	Ø 14 mm ID 3.2 mm
<b>NEW</b> FA400457	Black	77 cm	Ø 14 mm ID 3.2 mm
<b>NEW</b> FA400458	Black	81 cm	Ø 14 mm ID 3.2 mm
<b>NEW</b> FA400462	Lime	39 cm	Ø 14 mm ID 3.2 mm
<b>NEW</b> FA400463	Lime	48 cm	Ø 14 mm ID 3.2 mm
<b>NEW</b> FA400464	Lime	57 cm	Ø 14 mm ID 3.2 mm
<b>NEW</b> FA400465	Lime	63 cm	Ø 14 mm ID 3.2 mm
<b>NEW</b> FA400466	Lime	69 cm	Ø 14 mm ID 3.2 mm
FA400467	Lime	77 cm	Ø 14 mm ID 3.2 mm
FA400468	Lime	81 cm	Ø 14 mm ID 3.2 mm
FA400482	Red	39 cm	Ø 14 mm ID 3.2 mm
FA400483	Red	48 cm	Ø 14 mm ID 3.2 mm
FA400484	Red	57 cm	Ø 14 mm ID 3.2 mm
FA400485	Red	63 cm	Ø 14 mm ID 3.2 mm
FA400486	Red	69 cm	Ø 14 mm ID 3.2 mm
FA400487	Red	77 cm	Ø 14 mm ID 3.2 mm

## CIRCULAR BAND S45

Ø 16 mm

WORLD  
CHAMPIONSHIP  
CIRCULAR BANDS 2014MADE IN  
SPAIN

CODE	SIZE	STYLE	CASE PACK
FA400153	47 cm	Ø 16 mm	1
FA400154	58 cm	Ø 16 mm	1
FA400155	63 cm	Ø 16 mm	1
FA400156	69 cm	Ø 16 mm	1
FA400157	75 cm	Ø 16 mm	1

DESCRIPTION: Designed to use with Finned Shaft. Stainless steel spheres 7 mm maximum diameter; (bottleneck with lock out 2 mm in diameter). This design ensures the lock without forcing the knot too much and limiting the internal pressure on the rubber.

## CIRCULAR BAND

Ø 13 mm



CODE	SIZE	STYLE	CASE PACK
FA340019	26 cm	Ø 13 mm	6
FA340020	31 cm	Ø 13 mm	6
FA340021	34 cm	Ø 13 mm	6
FA340022	39 cm	Ø 13 mm	6
FA340023	44 cm	Ø 13 mm	6

DESCRIPTION: The rubber, in black color, is made from 100% natural latex by gravity extrusion, to maintain constant the diameter and so the mechanical properties of the band. The diameter of the band is 13mm. The diameter of the thread is 12 mm.

## PARALLEL BAND

Ø 16 mm



CODE	SIZE	STYLE	CASE PACK
FA400002	16 cm	Ø 16 mm	6
FA400003	18.5 cm	Ø 16 mm	6
FA400004	20 cm	Ø 16 mm	6
FA400005	22 cm	Ø 16 mm	6
FA400006	22.5 cm	Ø 16 mm	6
FA400007	27.5 cm	Ø 16 mm	6

DESCRIPTION: The rubber, in black color, is made from 100% natural latex by gravity extrusion, to maintain constant the diameter and so the mechanical properties of the band.





# REELS R20 - R30 - R50

## DOVETAIL MOUNTING SYSTEM

The frame and the central pin are in AISI 316 steel. The drilling on the frame itself allows it to be used also on arbalete spearguns of different brands. The special clutch provides an excellent closing torque. The assembly system allows easy maintenance and

cleaning. All sizes are equipped with a rewinder ring and size R50 is also equipped with an anti-blocking roller. The models R30 and R50 are equipped with a lightened drum in order to weigh as little as possible on the balance of the speargun.

### TECHNICAL FEATURES

- Reel of sturdy construction that combines the resistant Delrin material with assembly elements in AISI316 stainless steel
- Constructed from a single piece of Delrin which is worked by a high precision lathe
- Stainless steel mechanism
- Length for line: 50 m - 160 ft with line Ø 1.5 mm
- Dovetail mounting for quick assembly, compatible with many Cressi rifle models



Reel R20

DESCRIPTION: 65 ft - 20 m with line Ø 1.5 mm

CODE  
FA359020



Reel R30

DESCRIPTION: 100 ft - 30 m with line Ø 1.5 mm

CODE  
FA359030



Reel R50

DESCRIPTION: 160 ft - 50 m with line Ø 1.5 mm

CODE  
FA359050

# FISHING REEL

# HIGH TENACITY LINE



### TECHNICAL FEATURES

- Durable and effective
- Smooth multi-adjustable clutch style drag system
- Clutch style drag system, adjustable when paying-out line
- Ergonomic easily accessible star adjusting knob
- Vertical mount design for minimal drag
- Material: non-corrosive, impact resistant plastic
- Dimension: 10.9 X 15 x 9.4 cm

DESCRIPTION: 130 ft - 40 m with line Ø 1.5 mm  
Dovetail Mounting System Cherokee Ocean - Comanche 2.0 - Yuma - Mohicano

Reels are an essential accessories for spearfishing big fish. Prevents fish and gun loss. It's constructed from non-corrosive, durable and impact resistant plastic. The dovetail sleigh hook system to the gun is

placed so that the use of the different line-releasing devices is guaranteed, including the mechanical one activated by the trigger.

CODE  
FA359001



DESCRIPTION: Diameter: 2.5 mm | Length: 200 mt

CODE  
FA390030

# JOINTED WISHBONE TYPE A



CODE  
FA350020

# WISHBONE STANDARD



CODE  
FA350022

# COMPETITION NYLON THREAD

## 180



DESCRIPTION:  
Diameter: 1.80 mm  
Length: 5 m | 16.4 ft  
2 sleeves included

CODE  
FA354524

## 160



DESCRIPTION:  
Diameter: 1.60 mm  
Length: 5 m | 16.4 ft  
2 sleeves included

CODE  
FA354522

## 140



DESCRIPTION:  
Diameter: 1.40 mm  
Length: 5 m | 16.4 ft  
2 sleeves included

CODE  
FA354525

# SHOCK CORD

## W/ DYNEEMA



CODE  
FA354603

## W/ SNAP



CODE  
FA354604

## W/ PIGTAIL SWIVEL



CODE  
FA354605

# CRIMPING TOOL



Ideal for crimping mono and stainless steel with the perfectly sized compression jaws to properly crimp. Hardened for durability, these crimpers are ideal for rigging your speargun.

CODE  
FA354001

## TECHNICAL FEATURES

- High-Carbon Steel Material
- 4 Crimping Positions
- 2 Precision side Cutters



# CRIMPING TOOL SET

## DOVETAIL MOUNTING SYSTEM



Ideal for crimping mono and stainless steel with the perfectly sized compression jaws to properly crimp. Hardened for durability, these crimpers are ideal for rigging your speargun.

CODE  
FA354002

## TECHNICAL FEATURES

- High-Carbon Steel Material
- 4 Crimping Positions
- 2 Precision side Cutters





# COPPER DOUBLE BARREL CRIMP SLEEVES

Ø 1.6 mm



CODE	STYLE
FA354530	10 pcs
FA354531	50 pcs

Ø 1.8 mm



CODE	STYLE
FA354540	10 pcs
FA354541	50 pcs

Ø 2.0 mm



CODE	STYLE
FA354550	10 pcs
FA354551	50 pcs

## MULTIFILAMENT

Ø 1.6 mm 200 lb

CODE	COLOR	SIZE	DIAMETER
FM162025	Dark Blue	25 ft	Ø 1.6 mm
FM162050	Dark Blue	50 ft	Ø 1.6 mm
FM165025	Black	25 ft	Ø 1.6 mm
FM165050	Black	50 ft	Ø 1.6 mm
FM168025	Red	25 ft	Ø 1.6 mm
FM168050	Red	50 ft	Ø 1.6 mm
FM169025	Green	25 ft	Ø 1.6 mm
FM169050	Green	50 ft	Ø 1.6 mm

Ø 1.8 mm 300 lb

CODE	COLOR	SIZE	DIAMETER
FM182025	Dark Blue	25 ft	Ø 1.8 mm
FM182050	Dark Blue	50 ft	Ø 1.8 mm
FM185025	Black	25 ft	Ø 1.8 mm
FM185050	Black	50 ft	Ø 1.8 mm
FM188025	Red	25 ft	Ø 1.8 mm
FM188050	Red	50 ft	Ø 1.8 mm
FM189025	Green	25 ft	Ø 1.8 mm
FM189050	Green	50 ft	Ø 1.8 mm

Ø 2.0 mm 300 lb

CODE	COLOR	SIZE	DIAMETER
FM202025	Dark Blue	25 ft	Ø 2.0 mm
FM202050	Dark Blue	50 ft	Ø 2.0 mm
FM205025	Black	25 ft	Ø 2.0 mm
FM205050	Black	50 ft	Ø 2.0 mm
FM208025	Red	25 ft	Ø 2.0 mm
FM208050	Red	50 ft	Ø 2.0 mm
FM209025	Green	25 ft	Ø 2.0 mm
FM209050	Green	50 ft	Ø 2.0 mm



# DRY GUN BAG



## TECHNICAL FEATURES

- 840 Denier Nylon with waterproof coating
- YKK zip closing long 133 cm | 52.5 in
- Dimensions: 179 x 30.5 x 20 cm | 70 x 12 x 7.9 in
- Reinforced side handle and shoulder strap



A beautiful bag for carrying the spearguns. It features an adjustable shoulder strap and a reinforced handle. It has YKK zip closing long 52.5 in | 133 cm. Inside there is a small pocket with velcro closure. On the top, you can roll and close firmly thanks to the adjustable buckles. Thanks to the special coating the bag is waterproof and will protect the equipment inside. It is long approximately 70 in (179 cm), enough for carrying long spearguns or other equipment. It is an ideal bag for the spearfishing man that want to protect and easily transport his gear.



CODE	CASE PACK
UA926200	4

# NIKITA



CODE	CASE PACK
UA926500	5

# MACH NEW 2024

## PRECISION & VERSATILITY

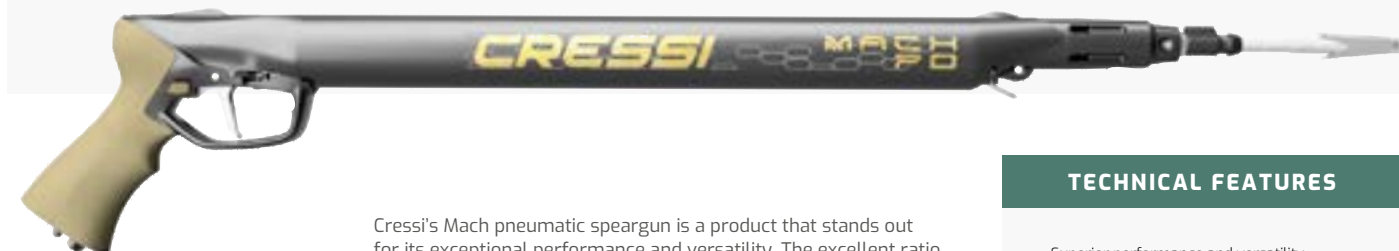

Cressi's Mach pneumatic speargun is a product that stands out for its exceptional performance and versatility. The excellent ratio between size and power makes it ideal for both beginner and experienced fishermen. The offset shaft allows for easy and precise pointing, enhancing the fishing experience; furthermore, the muzzle with large outlets is designed in such a way as to avoid energy dispersion when the shaft is released, guaranteeing greater power and shooting precision.

Another innovation is the side rod release. This system simplifies reel operation and loading, allowing the angler to easily handle the rifle. The steel trigger offers great sensitivity in shooting, allowing the action to be precisely controlled.

### TECHNICAL FEATURES

- Superior performance and versatility
- Easy and accurate pointing
- Side rod release
- Upgraded muzzle with incorporated holes for water drainage
- Power reducer version available



Ø 8 mm THREADED SHAFT



ROD SIDE RELEASE



WATER DRAINAGE TECHNOLOGY



RESPONSIVE STEEL TRIGGER

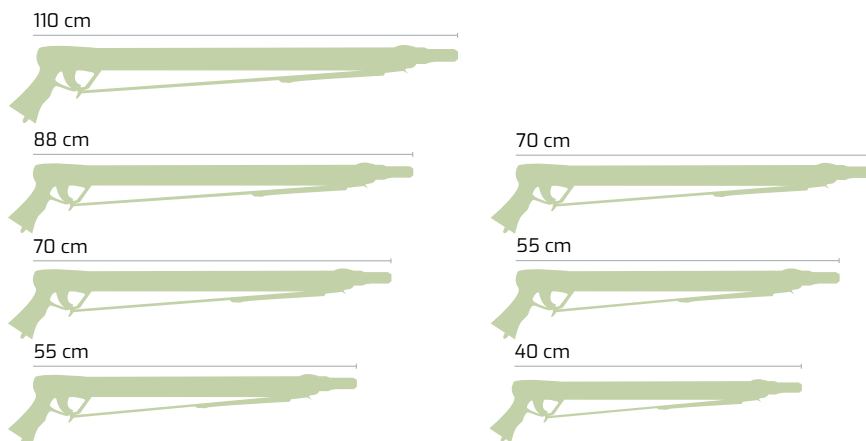

CODE	PRODUCT	SIZE	CASE PACK
FR410040	MACH 40	40 cm	6
FR410055	MACH 55	55 cm	6
FR410070	MACH 70	70 cm	6
FS410055	MACH W/ POWER REDUCER 55	55 cm	6
FS410070	MACH W/ POWER REDUCER 70	70 cm	6
FS410088	MACH W/ POWER REDUCER 88	88 cm	6
FS410110	MACH W/ POWER REDUCER 110	110 cm	6





# SL STAR

PRODUCT  
UPDATE

## THE HISTORY OF OUR PNEUMATIC GUNS

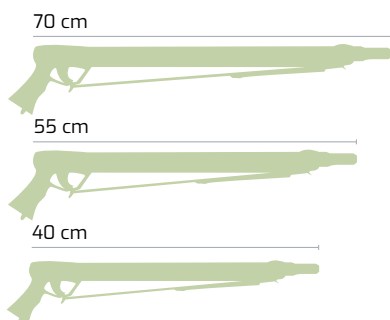

The SL Star range of pneumatic spear guns has been in production for many years now, and they have won worldwide fame for their excellence in terms of robustness, reliability, precision and powerful shooting. The various models correspond to the equivalent models in the SL series, without power reducer. Constantly updated over the years, the SL Star spear guns are ultra light, easy to use, and fire quickly. They come with anatomical high grip butts enabling the gun to be held in line with the arm with no extra effort. The bright red butt means you can identify the gun even if it ends up on the sea-bottom after shooting.

CODE	SIZE	CASE PACK
FR374000	40 cm	6
FR375500	55 cm	6
FR377000	70 cm	6

### ACCESSORIES

CODE	PRODUCT
FA390001	MINI SPEAR HEAD
FA390004	MACH SPEAR HEAD 2-FLOPPER
FA390020	PRESSURE GAUGE for SL/SL STAR
FA320060	HAND PUMP for SL   SL STAR
FA354523	SHAFT REFLOATER for PNEUMATIC GUNS

### SPARE PARTS

CODE	PRODUCT	GUN LENGTH
FA360036	STAINLESS STEEL THREADED SHAFT Ø 8.0mm (36.5cm)	35 cm
FA361036	STAINLESS STEEL THREADED SHAFT Ø 8.0mm (55cm)	45 cm
FA362036	STAINLESS STEEL THREADED SHAFT Ø 8.0mm (68.5cm)	60 cm

### TECHNICAL FEATURES

- A strong line hook is situated on the bottom of the butt for shaft loading
- It is fitted with a safety catch and, when the trigger is pulled, it frees the line-releasing device



Ø 8 Mm THREADED SHAFT



Ø 13 Mm INTERNAL BARREL



OFFSET BARREL

# SL STAR

# PNEUMATIC GUN SHAFTS

FOR CRESSI PNEUMATIC SPEARGUNS, THREADED TO FIT ANY CRESSI THREADED SPEAR TIP

## MAESTRALE NEW 2024

PNEUMATIC GUN SHAFT: PR80 THREADED



CODE	GUN LENGTH
FA372801	36.5 cm
FA372802	55 cm
FA372803	68.5 cm
FA372804	99.5 cm
FA372806	109.5 cm

## SCIROCCO

PNEUMATIC GUN SHAFT: INOX THREADED



Tempered steel shaft

CODE	GUN LENGTH
FA360030	36.5 cm
FA360031	55 cm
FA360032	68.5 cm
FA360033	99.5 cm
FA360035	109.5 cm

## LIBECCIO

PNEUMATIC GUN SHAFT: PR80 THREADED



CODE	GUN LENGTH
FA360036	36.5 cm
FA361036	55 cm
FA362036	68.5 cm
FA363036	87.5 cm
FA365036	99.5 cm
FA366036	109.5 cm

# SPEARHEADS

FOR PNEUMATIC SPEARGUNS

Stainless steel construction | Dual flopper design | Ø 6 mm internal thread

## MINI SPEAR HEAD

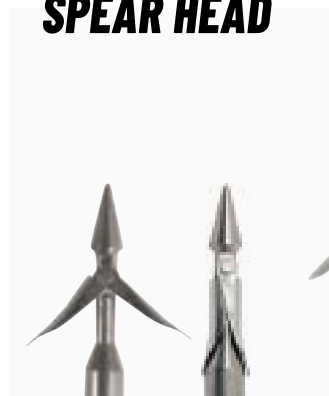

**DESCRIPTION:**  
The Mini Spear Head is a dual flopper. Conical point. Threaded spear tip. Made with corrosion resistant Stainless Steel. The dual flopper setup tucks neatly against the relieved tip for the ultimate in penetration. Yet provides dual flippers for the ultimate in fish holding power. Threaded to fit Pneumatic shafts and threaded Euro shafts.

## MACH SPEAR HEAD



**DESCRIPTION:**  
The Mach Spear Head is a dual flopper. Conical point. Threaded spear tip. The Stainless Steel dual flopper setup fold against the tip for the ultimate in penetration. Yet provides dual flippers for the ultimate in fish holding power. Threaded to fit Pneumatic shafts and threaded Euro shafts.

CODE	PRODUCT
FA390001	MINI SPEAR HEAD
FA390004	MACH SPEAR HEAD 2-FLOPPER

# MULTIPRONGS

FIT ON Ø 7 mm & Ø 8 mm SHAFTS



## 3 PRONGS SPEAR HEAD

CODE	CASE PACK
FA390008	5

# REEL MOUNT NEW 2024

OLEOPNEUMATIC REEL ADAPTER



CODE	CASE PACK
FA359200	5

## SHAFT REFLOATER



CODE  
FA354523

## SHAFT LOADER



CODE  
FA390018

## SPEARGUN OIL 100 ml



CODE  
FA390022

## PRESSURE GAUGE

SL • SL STAR



CODE  
FA390020

## PRESSURE GAUGE

SAETTA • SAETTA PRO



CODE  
FA390032

## HAND PUMP

SAETTA • SAETTA PRO



CODE  
FZ370073





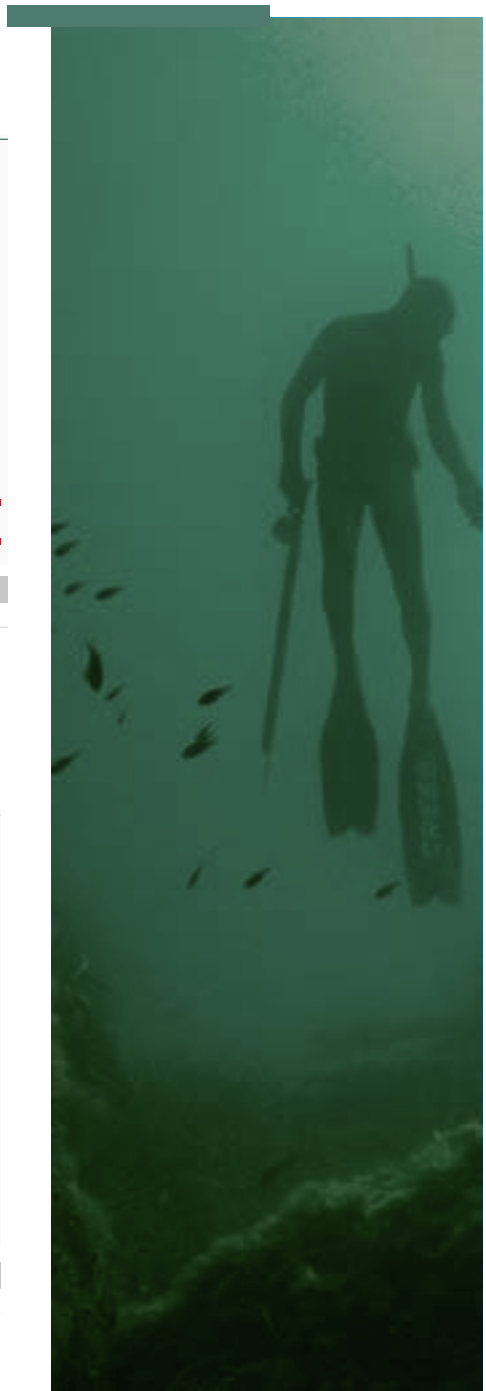

## HAND PUMP

SL • SL STAR





CODE  
FA320060



GUN DETAILS															
RUBBER SPEARGUN		OVERALL LENGTH cm - in		POWER LENGTH cm - in		BAR-REL Ø mm	SHOT RANGE m - ft		READY TO USE	SHOCK ABSORBER INCLUDED	MUZZLE TYPE	LINE LOOP	SHAFT CODE	MATERIAL	Ø mm
	CHEROKEE POWER 90					28			NO	YES	2x Circular Band Muzzle	2	FA406120	17-4 Ph Stainless Steel	7
	CHEROKEE POWER 100	138	54.3	104	40.9	28	6.9	22.7	NO	YES	2x Circular Band Muzzle	2	FA406130	17-4 Ph Stainless Steel	7
	CHEROKEE POWER 110	148	58.2	114	44.8	28	7.4	24.3	NO	YES	2x Circular Band Muzzle	2	FA406140	17-4 Ph Stainless Steel	7
	CHEROKEE POWER 120	158	62.2	124	48.8	28	7.8	25.8	NO	YES	2x Circular Band Muzzle	2	FA406150	17-4 Ph Stainless Steel	7
	CHEROKEE POWER 130	168	66.1	134	52.7	28	8.3	27.4	NO	YES	2x Circular Band Muzzle	2	FA406160	17-4 Ph Stainless Steel	7
	CHEROKEE FAST 75	113	44.4	79	31.1	28	5.5	18.1	NO	YES	2x Circular Band Muzzle	1	FA404903	17-4 Ph Stainless Steel	6.5
	CHEROKEE FAST 90	128	50.3	94	37.0	28	6.2	20.3	NO	YES	2x Circular Band Muzzle	1	FA404904	17-4 Ph Stainless Steel	6.5
	CHEROKEE FAST 100	138	54.3	104	40.9	28	6.6	21.8	NO	YES	2x Circular Band Muzzle	1	FA404905	17-4 Ph Stainless Steel	6.5
	CHEROKEE FAST 110	148	58.2	114	44.8	28	7.1	23.3	NO	YES	2x Circular Band Muzzle	1	FA404906	17-4 Ph Stainless Steel	6.5
	CHEROKEE FAST 120	158	62.2	124	48.8	28	7.5	24.9	NO	YES	2x Circular Band Muzzle	1	FA404907	17-4 Ph Stainless Steel	6.5
	CHEROKEE EXO 60	98	38.5	64	25.1	28	4.5	14.9	NO	YES	2x Circular Band Muzzle	1	FA404902	17-4 Ph Stainless Steel	6.5
	CHEROKEE EXO 75	113	44.4	79	31.1	28	5.2	17.0	NO	YES	2x Circular Band Muzzle	1	FA404903	17-4 Ph Stainless Steel	6.5
	CHEROKEE EXO 90	128	50.3	94	37.0	28	5.8	19.1	NO	YES	2x Circular Band Muzzle	1	FA404904	17-4 Ph Stainless Steel	6.5
	CHEROKEE EXO 100	138	54.3	104	40.9	28	6.2	20.6	NO	YES	2x Circular Band Muzzle	1	FA404905	17-4 Ph Stainless Steel	6.5
	CHEROKEE EXO 110	148	58.2	114	44.8	28	6.7	22.0	NO	YES	2x Circular Band Muzzle	1	FA404906	17-4 Ph Stainless Steel	6.5
	COMANCHE RAIL 60	102	40.1	60	23.6	28	4.3	14.1	YES	NO	1x Parallel + 1x Circular Band Muzzle	1	FA410002	17-4 Ph Stainless Steel	6
	COMANCHE RAIL 75	127	50.0	75	29.5	28	5.3	17.4	YES	NO	1x Parallel + 1x Circular Band Muzzle	1	FA410004	17-4 Ph Stainless Steel	6
	COMANCHE RAIL 90	142	55.9	90	35.4	28	5.9	19.4	YES	NO	1x Parallel + 1x Circular Band Muzzle	1	FA410006	17-4 Ph Stainless Steel	6
	COMANCHE RAIL 100	152	59.8	100	39.3	28	6.3	20.7	YES	NO	1x Parallel + 1x Circular Band Muzzle	1	FA410007	17-4 Ph Stainless Steel	6
	COMANCHE RAIL 110	162	63.7	110	43.3	28	6.7	22.0	YES	NO	1x Parallel + 1x Circular Band Muzzle	1	FA410008	17-4 Ph Stainless Steel	6
	YUMA FAST 60	102	40.1	64	25.1	26	4.3	14.1	NO	YES	2x Circular Band Muzzle	1	FA407090	17-4 Ph Stainless Steel	6
	YUMA FAST 75	117	46.0	79	31.1	26	4.9	16.1	NO	YES	2x Circular Band Muzzle	1	FA407105	17-4 Ph Stainless Steel	6
	YUMA FAST 90	132	51.9	94	37.0	26	5.5	18.1	NO	YES	2x Circular Band Muzzle	1	FA407120	17-4 Ph Stainless Steel	6
	YUMA FAST 100	142	55.9	104	40.9	26	5.9	19.4	NO	YES	2x Circular Band Muzzle	1	FA407130	17-4 Ph Stainless Steel	6
	APACHE 35	67	26.3	30	11.8	28	3.0	10.1	NO	NO	1x Circular Band Muzzle	1	FA350535	Pr80 Galvanized Spring	7
	APACHE 45	77	30.3	40	15.7	28	3.4	11.3	NO	NO	1x Circular Band Muzzle	1	FA350545	Pr80 Galvanized Spring	7
	APACHE 60	87	34.2	55	21.6	28	3.8	12.6	NO	NO	1x Circular Band Muzzle	1	FA350560	Pr80 Galvanized Spring	7
	APACHE 75	102	40.1	70	27.5	28	4.4	14.5	NO	NO	1x Circular Band Muzzle	1	FA350575	Pr80 Galvanized Spring	7
	APACHE 90	117	46.0	85	33.4	28	4.9	16.3	NO	NO	1x Circular Band Muzzle	1	FA350590	Pr80 Galvanized Spring	7

GUN DETAILS

PNEUMATIC SPEARGUN		READY TWO USE SET	SHOCK ABSORBER INCLUDED	SHOT RANGE m - ft		TOTAL LENGTH GUN + SPEAR cm	BARREL DIAMETER mm	LINE LOOP	
	SAETTA 40	NO	NO	2.4	7.9	70	13	2	
	SAETTA 55	NO	NO	3.0	9.8	85	13	2	
	SAETTA 70	NO	NO	3.4	11.4	100	13	2	
	SAETTA W/REDUCER 55	NO	NO	3.0	9.8	85	13	2	
	SAETTA W/REDUCER 70	NO	NO	3.4	11.4	100	13	2	
	SAETTA W/REDUCER 88	NO	NO	4.1	13.5	118	13	2	
	SAETTA W/REDUCER 110	NO	NO	4.8	15.9	140	13	2	
	SL STAR 40	NO	NO	2.2	7.3	70	13	2	
	SL STAR 55	NO	NO	2.7	9.0	85	13	2	
	SL STAR 70	NO	NO	3.1	10.4	100	13	2	



SHAFT DETAILS						POWER BAND DETAILS								
LENGTH cm	FLOPPER TYPE	TAB N°	TAB TYPE	REST TAB	POINT TYPE	COMPATIBLE SHAFTS Ø RANGE mm	COMPATIBLE SHAFTS LENGTHS RANGE cm	BAND CODE	N°	TYPE	MATERIAL	Ø mm	LENGTH mm	WISHBONE
120	Bottom Flopper	2	Large Sharkfin	YES	PIN POINT	From 6 to 7	120/130	FA400524	2X	Circular	Dipped Natural Latex	16	57	DYNEEMA® SK78
130	Bottom Flopper	2	Large Sharkfin	YES	PIN POINT	From 6 to 7	130/145	FA400525	2x	Circular	Dipped Natural Rubber Latex	16	63	DYNEEMA® SK78
140	Bottom Flopper	2	Large Sharkfin	YES	PIN POINT	From 6 to 7	140/155	FA400526	2x	Circular	Dipped Natural Rubber Latex	16	69.5	DYNEEMA® SK78
150	Bottom Flopper	2	Large Sharkfin	YES	PIN POINT	From 6 to 7	150/165	FA400527	2x	Circular	Dipped Natural Rubber Latex	16	77	DYNEEMA® SK78
160	Bottom Flopper	2	Large Sharkfin	YES	PIN POINT	From 6 to 7	160/175	FA400528	2x	Circular	Dipped Natural Rubber Latex	16	83	DYNEEMA® SK78
105	Bottom Flopper	2	Mini Sharkfin	NO	PIN POINT	From 6 to 7	105/120	FA400483	2x	Circular	Dipped Natural Rubber Latex	14	48	DYNEEMA® SK78
120	Bottom Flopper	2	Mini Sharkfin	YES	PIN POINT	From 6 to 7	120/135	FA400484	2x	Circular	Dipped Natural Rubber Latex	14	57	DYNEEMA® SK78
130	Bottom Flopper	2	Mini Sharkfin	YES	PIN POINT	From 6 to 7	130/145	FA400485	2x	Circular	Dipped Natural Rubber Latex	14	63	DYNEEMA® SK78
140	Bottom Flopper	2	Mini Sharkfin	YES	PIN POINT	From 6 to 7	140/155	FA400486	2x	Circular	Dipped Natural Rubber Latex	14	69.5	DYNEEMA® SK78
150	Bottom Flopper	2	Mini Sharkfin	YES	PIN POINT	From 6 to 7	150/165	FA400487	2x	Circular	Dipped Natural Rubber Latex	14	77	DYNEEMA® SK78
90	Bottom Flopper	2	Mini Sharkfin	NO	PIN POINT	From 6 to 7	90/105	FA400562	1x	Circular	Dipped Natural Rubber Latex	16	39	DYNEEMA® SK78
105	Bottom Flopper	2	Mini Sharkfin	NO	PIN POINT	From 6 to 7	105/120	FA400563	1x	Circular	Dipped Natural Rubber Latex	16	48	DYNEEMA® SK78
120	Bottom Flopper	2	Mini Sharkfin	YES	PIN POINT	From 6 to 7	120/135	FA400564	1x	Circular	Dipped Natural Rubber Latex	16	57	DYNEEMA® SK78
130	Bottom Flopper	2	Mini Sharkfin	YES	PIN POINT	From 6 to 7	130/145	FA400565	1x	Circular	Dipped Natural Rubber Latex	16	63	DYNEEMA® SK78
140	Bottom Flopper	2	Mini Sharkfin	YES	PIN POINT	From 6 to 7	140/155	FA400566	1x	Circular	Dipped Natural Rubber Latex	16	69.5	DYNEEMA® SK78
90	Top Flopper	2	Smooth Notch	NO	PIN POINT	From 6 to 7	90-105	FA400002	1x	Parallel	Synthetic	16	16	JOINTED-WISHBONE
115	Top Flopper	2	Smooth Notch	NO	PIN POINT	From 6 to 7	105-120	FA400003	1x	Parallel	Synthetic	16	18.5	JOINTED-WISHBONE
130	Top Flopper	2	Smooth Notch	YES	PIN POINT	From 6 to 7	120-135	FA400005	1x	Parallel	Synthetic	16	22	JOINTED-WISHBONE
140	Top Flopper	2	Smooth Notch	YES	PIN POINT	From 6 to 7	130-145	FA400006	1x	Parallel	Synthetic	16	25.5	JOINTED-WISHBONE
150	Top Flopper	2	Smooth Notch	YES	PIN POINT	From 6 to 7	140-155	FA400007	1x	Parallel	Synthetic	16	27.5	JOINTED-WISHBONE
90	Bottom Flopper	2	Mini Sharkfin	NO	PIN POINT	Up to 6	90-95	FA400482	1x	Circular	Dipped Natural Rubber Latex	14	39	DYNEEMA® SK78
105	Bottom Flopper	2	Mini Sharkfin	NO	PIN POINT	Up to 6	105-110	FA400483	1x	Circular	Dipped Natural Rubber Latex	14	48	DYNEEMA® SK78
120	Bottom Flopper	2	Mini Sharkfin	YES	PIN POINT	Up to 6	120-125	FA400484	1x	Circular	Dipped Natural Rubber Latex	14	57	DYNEEMA® SK78
130	Bottom Flopper	2	Mini Sharkfin	YES	PIN POINT	Up to 6	130-135	FA400485	1x	Circular	Dipped Natural Rubber Latex	14	63	DYNEEMA® SK78
65	Thread Spear Flopper	2	Sharp Notch	NO	PIN POINT	From 6 to 7	-	FA340019	1x	Circular	Synthetic	13	24	STANDARD-WISHBONE
75	Thread Spear Flopper	2	Sharp Notch	NO	PIN POINT	From 6 to 7	-	FA340020	1x	Circular	Synthetic	13	31	STANDARD-WISHBONE
85	Thread Spear Flopper	2	Sharp Notch	NO	PIN POINT	From 6 to 7	-	FA340021	1x	Circular	Synthetic	13	34	STANDARD-WISHBONE
100	Thread Spear Flopper	2	Sharp Notch	NO	PIN POINT	From 6 to 7	-	FA340022	1x	Circular	Synthetic	13	39	STANDARD-WISHBONE
115	Thread Spear Flopper	2	Sharp Notch	NO	PIN POINT	From 6 to 7	-	FA340023	1x	Circular	Synthetic	13	44	STANDARD-WISHBONE

EASIER LOADING PRESSURE		STANDARD PRESSURE		HARDER LOADING PRESSURE		SHAFT DETAILS					
BAR	PSI	BAR	PSI	BAR	PSI	MATERIAL	DIAMETER mm	LENGTH cm	FLOPPER TYPE	POINT TYPE	INCLUDED SHAFT SKU
16	232	18	261	24	348	PR80 GALVANIZED SPRING	8.0	36.5 (+10)	THREAD SPEAR FLOPPER	PIN POINT	FA360036
16	232	18	261	24	348	PR80 GALVANIZED SPRING	8.0	55.0 (+10)	THREAD SPEAR FLOPPER	PIN POINT	FA361036
16	232	18	261	24	348	PR80 GALVANIZED SPRING	8.0	68.5 (+10)	THREAD SPEAR FLOPPER	PIN POINT	FA362036
16	232	18	261	24	348	PR80 GALVANIZED SPRING	8.0	55.0 (+10)	THREAD SPEAR FLOPPER	PIN POINT	FA361036
16	232	18	261	24	348	PR80 GALVANIZED SPRING	8.0	68.5 (+10)	THREAD SPEAR FLOPPER	PIN POINT	FA362036
16	232	18	261	24	348	PR80 GALVANIZED SPRING	8.0	87.5 (+10)	THREAD SPEAR FLOPPER	PIN POINT	FA363036
16	232	18	261	24	348	PR80 GALVANIZED SPRING	8.0	109.5 (+10)	THREAD SPEAR FLOPPER	PIN POINT	FA366036
16	232	18	261	24	348	PR80 GALVANIZED SPRING	8.0	36.5 (+10)	THREAD SPEAR FLOPPER	PIN POINT	FA360036
16	232	18	261	24	348	PR80 GALVANIZED SPRING	8.0	55.0 (+10)	THREAD SPEAR FLOPPER	PIN POINT	FA361036
16	232	18	261	24	348	PR80 GALVANIZED SPRING	8.0	68.5 (+10)	THREAD SPEAR FLOPPER	PIN POINT	FA362036

# ALUMINUM

## ALUMINUM 3-PIECE POLE SPEAR

The Aluminum pole spear is the perfect solution for traveling hunters. Threaded lightweight sections break down to fit in a typical dive bag and can be quickly assembled once at the dive site. Included is a 3-prongs "Lionfish Cluster" tip and high-quality power band. Other tips are available as accessories, not included. The 3 pieces modular design gives the possibility to choose different assembling for the spearfisherman needs.

### TECHNICAL FEATURES

- Thick-walled aluminum construction for durability
- Threaded joints join quickly and securely
- 3-prong lionfish paralyzer tip included

3 PIECES: 6.5 ft LONG FOR NORMAL HUNTING CONDITIONS  
 2 PIECES: 4.9 ft LONG FOR CLOSE RANGE HUNTING AND LION FISH HUNTING  
 1 PIECE: 2.7 ft LONG STRICTLY FOR LION FISHES



2024 - CATALOG

CODE	SIZE	STYLE	CASE PACK
USX040000	6.5 ft	3 pcs	5



OVERALL FULL LENGTH 6.5 ft (200 cm)

CRESSI

# FG1

## FIBERGLASS MONO-PIECE POLE SPEAR

The FG1 is the ultimate pole spear made in fiberglass to ensure lightness and speed while underwater. Ideal for traveling and perfect for small to medium size fish. The top ends with a male fitting of 6 mm and two spanner flats that allow tightening using a wrench. It features an elastic rubber band made of OD latex tube with a cord inside installed to the hole. A Paralyzer Tip, composed of 3 tiny barb prongs is included.



CODE	CASE PACK
FP015001	5

# FG2

## FIBERGLASS 2-PIECE POLE SPEAR

The FG2 is the ultimate pole spear made in fiberglass to ensure lightness and speed while underwater. Ideal for traveling and perfect for small to medium size fish. The top ends with a male fitting of 6 mm and two spanner flats that allows tightening using a wrench. The pole is 182.5 cm | 72 in long and has a diameter of 13 mm. The rubber sling is made using a Ø 9 mm OD latex tube with a cord inside, installed to the hole. The latex tube length is 76 cm | 30 in, cord length is 22 cm | 8.5 in. Total length of 98 cm | 38.6 in. A Paralyzer Tip, composed of 3 tiny barb prongs, 30.5 cm | 12 in long, is included. Underwater fishing is a way of life and must be done responsibly and sustainably for the environment. Choose your prey well and fish only what is sufficient for feeding yourself, respect nature.



CODE	CASE PACK
FP015002	5

# FG3

## FIBERGLASS 3-PIECE POLE SPEAR

The FG3 is the ultimate pole spear made in fiberglass to ensure lightness and speed while underwater. Ideal for traveling and perfect for small to medium size fish. The top ends with a male fitting and two spanner flats that allow tightening using a wrench. It's composed of 3 pieces that can be assembled as desired. The threaded tip can accommodate different paralyzed tips.



CODE	CASE PACK
FP015003	5

### TECHNICAL FEATURES

- Pole spear made in fiberglass for ensure lightness and speed while underwater.
- The bottom end is rounded with a hole for the rubber sling.
- The top ends with a male fitting of 6 mm and two spanner flats that allows tightening using a wrench.
- The rubber sling is made using a Ø 10 mm OD latex tube with cord inside, installed to the hole.
- Paralyzer tip composed of 3 tiny barb prongs, 25 cm | 10 in long, is included.

# POLE SPEAR ACCESSORIES

## FG POLE EXTENSION



CODE	SIZE	COLOR
FZ390155	79 cm	Black

## 3 BARBLESS PRONGS PARALYZER TIP



DESCRIPTION: 3 Barbless Prongs  
 Total length: 14 in - 35.5 cm  
 Tip Ø: 5/8 in - 16 mm  
 Thread Ø: 15/64 in - 6 mm

CODE
USX020000

## 5 BARB PRONGS PARALYZER TIP



DESCRIPTION: 5 Barbless Prongs  
 Total length: 6 in - 15.2 cm  
 Tip Ø: 5/8 in - 16 mm  
 Thread Ø: 15/64 in - 6 mm

CODE
FZ390006

## POLE SPEAR POWER BAND



DESCRIPTION:  
 Rubber length: 29 1/8 in - 74 cm  
 Cord length: 8 5/8 in - 22 cm  
 Total length: 37 6/8 in - 96 cm  
 Rubber Ø: 3/8 in - 0.9 mm

CODE	SIZE	STYLE
FZ390007	75 cm	Ø 9 mm
FZ390008	115 cm	Ø 9 mm

## TIP ADAPTOR 11 mm



DESCRIPTION:  
 Inside Ø: 11 mm  
 Outer Ø: 6 mm

CODE
USX030000







# TORCHES & KNIVES

SPEARFISHING





# LUMIA+

## ULTRA LED DIVE LAMP



EXCELLENT ERGONOMICS THANKS TO THERMOPLASTIC RUBBER COATING AND HIGHLY ASYMMETRIC DESIGN

SWITCH WITH 3 POSITIONS ON | OFF | HOLDING ON WITH AUTOMATIC RETURN

NARROWED LIGHT BEAM APPROXIMATELY 6° SPOT LIGHT BEAM THANKS TO TIR LENS

ADJUSTABLE ELASTIC STRAP TO CUSTOMISE THE USE ACCORDING TO YOUR NEEDS

NEUTRAL WHITE COLOR TEMPERATURE SIMILAR TO SUNLIGHT FOR MAXIMUM RETURN OF THE COLORS

NEW  
WHITE COLOR  
LED LIGHT

### TECHNICAL FEATURES

- Luminous Flux: 300 Lumens
- Color Temperature: 6500 °K CRI>75
- Burn Time: 3.5 h
- Viewing Angle: 6°
- Illuminance: 30000 Lux
- Impact Resistance: 1,5 m
- Ingress Protection Code: PX-8 75m

### NEW WHITE COLOR TEMPERATURE

The LED has a white color temperature similar to sunlight for maximum return of the colors in the underwater environment. The light beam of the LED is narrowed into a spot light beam of about 6° by means of a lens made of ultra-transparent material protected by the polycarbonate optical porthole.

### ACTIVE ELECTRONICS

Power is supplied by four AA batteries, either alkaline or rechargeable. The power supply has an electronic management system that eliminates the gap between the different electrical potentials of different types of batteries and ensures an efficiency of 30% higher than the commonly used systems. The active electronics of the flashlight guarantee constant light, even when the battery charge decreases. When the charge drops below the safety threshold value, the lighting level will reduce to warn the user that the batteries are depleted.

<b>Length</b>	168 mm - 6.61 in
<b>Head diameter</b>	47 mm - 1.85 in
<b>Weight</b>	130 g - 4.58 oz (without batteries)

Torch with a highly asymmetric design boasts excellent ergonomics and a highly tactile perception of its geometric characteristics. Thanks to this particular design, the switch position is immediately found without needing to use your eyesight. The porthole and body are coated with thermoplastic rubber to extend shelf life and reduce noises from impact when used for fishing. These ergonomic features are a big advantage over aluminium torches with a circular section which do not give feedback on the position of the grip and, in some cases, even require the use of two hands to turn it on.

The switch has three positions: Off, On Unstable with Automatic Return, On. The "On Unstable" position is particularly useful in fishing because it allows flashing by one simple press. The strap with slider spring allows adjustment according to the user's needs, but being elastic can be pulled out in case of emergency. Power is supplied by four AA batteries, either alkaline or rechargeable. The electronics ensure a constant level of brightness even when the batteries are rechargeable and/or not fully charged. Batteries included.



BLACK/BLACK



BLACK/GREY



### LUMIA+ HIGH RANGE COLOR SPECTRUM



### STANDARD LIGHT LIMITED RANGE COLOR SPECTRUM

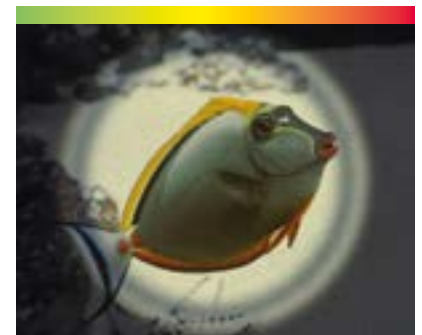

CODE	COLOR	CASE PACK
SJ550150	Black/Black	10
SJ550170	Black/Grey	10

# ORCA

STAINLESS STEEL

MADE IN ITALY



This legendary product has been around for years and years and has now become a sought-after collector's item. It is considerably heavy and large, perfect for a work tool, which this knife is designed to be. The large blade is forged from special steel, with a smooth edge on one side and partly serrated on the other.

Blade length	17,8 cm - 7 in
Total length	30 cm - 11 3/4 in
Blade width	32 mm - 1 1/4 in
Blade thickness	5,5 mm - 1/4 in
Knife-only weight	450 g - 1 lb
Weight with sheath	600 g - 1 lb 5 oz

CODE	CASE PACK
RC556000	10

### SPARE PARTS

CODE	PRODUCT
RZ550003	SHEATH W/ STRAPS for ORCA
RZ551007	HOLDER for TOTEM/ORCA
RZ550018	STRAPS for KNIVES (PAIR)

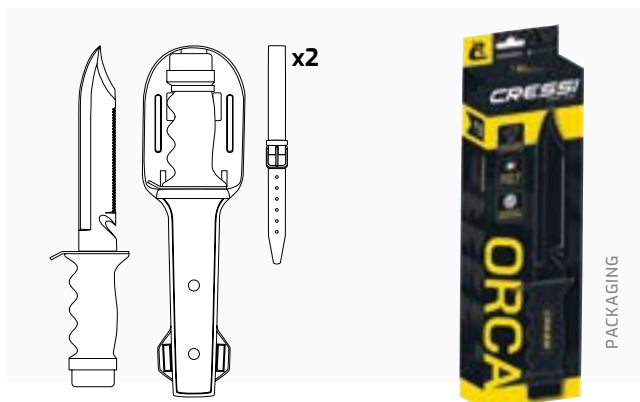

# GIANT

STAINLESS STEEL 304

MADE IN ITALY



Knife having large dimensions that make it particularly effective during use. Perfect as a work tool or for particularly intensive use. Made of AISI 420 tempered steel and black coating.

Blade length	17,8 cm - 7 in
Total length	30,0 cm - 11 3/4 in
Blade width	29,7 mm - 1 3/16 in
Blade thickness	5,2 mm - 7/32 in
Knife-only weight	271 g - 9.6 oz
Weight with sheath	429 g - 15.1 oz

CODE	CASE PACK
RC556500	10

### SPARE PARTS

CODE
RZ550015

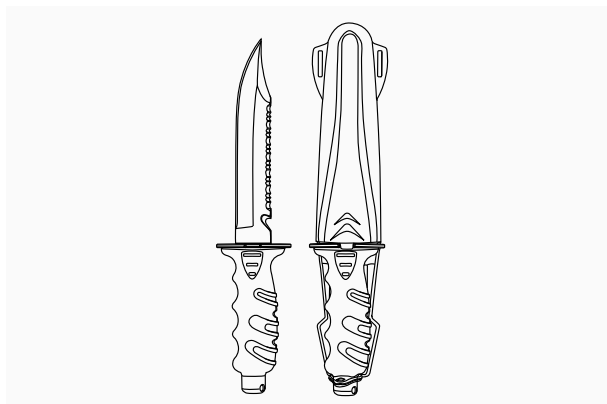



# LIZARD

NEW COLOR 2024

STAINLESS STEEL W 1.14116

MADE IN ITALY



BLACK/BLACK

Italian-made professional, multipurpose diver's knife, with blade and handle in w 1.14116 martensitic stainless steel, hardness HRC 55/56, for an extremely sharp and honed blade. A knife with a dagger handle designed specifically for fishing. In the body of the knife a part is intended for the extraction of stranded shafts and for straightening them. The knife can be removed from its sheath quickly and with one hand thanks to a special mechanical system.

Blade length	10,5 cm - 4 1/8 in
Total length	21 cm - 8 1/4 in
Thickness blade	3,8 mm - 5/32 in



CODE	COLOR
RC559600	BLACK
NEW RC559680	RED
NEW RC559690	GREEN

# SNAKE

NEW 2024

STAINLESS STEEL W 1.14116

MADE IN ITALY



Easy to pull out and reinsert into the sheath, it can be done without having to look. The Snake's blade is designed to offer a perfect balance between edge retention and corrosion resistance. This means you can count on a sharp and durable blade that will maintain its edge over time and withstand the most adverse conditions. The Snake's main innovation is its quick release and rod catcher integrated into the handle. This feature allows the knife to be pulled out and stored quickly and effortlessly, offering greater convenience and safety during use. In addition, the integrated rod breaker makes it easy to break glass in emergency situations, making the Snake a versatile and reliable knife in a variety of circumstances.

Blade length	8,1 cm - 3 3/16 in
Total length	18,6 cm - 7 5/16 in
Thickness blade	3,8 mm - 5/32 in

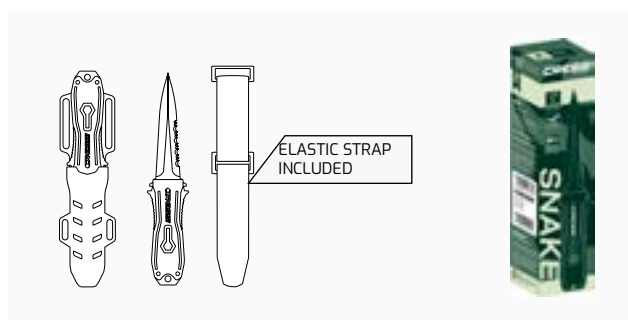

CODE	CASE PACK
RC559850	10

# FINISHER

STAINLESS STEEL



**420** JAPANESE  
420 STEEL

The Finisher is a medium-sized stiletto knife, designed for spearfishing. Handy, great penetration of the blade, resistance, and grip. The blade is extended through the inside of the handle and it has screwed a little pot on the end. It features 420 tempered steel and Black Coating. The blade features one side with a smooth edge and the other with a serrated edge. It has a comfortable grip with a rubbery technopolymer coating and a plastic sheath that is very hydrodynamic with the fixation of the knife by means of a rubber ring.

CODE	CASE PACK
RC559300	10

<b>Blade length</b>	12,7 cm - 5 in
<b>Total length</b>	24,7 cm - 9 3/4 in
<b>Blade width</b>	17 mm - 21/32 in
<b>Blade thicknesses</b>	3-5 mm -1/8-3/16 in
<b>Knife-only weight</b>	130 g - 4.6 oz
<b>Weight with sheath</b>	200 g - 7.1 oz

SPARE PARTS

CODE	PRODUCT
RZ550016	SHEATH for FINISHER KNIFE
RZ550018	STRAPS for KNIVES (PAIR)

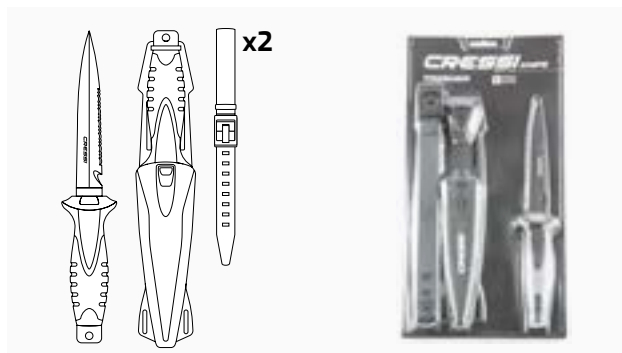

# BORG

STAINLESS STEEL



**304** JAPANESE  
STEEL

The Borg is a modern, large knife with a futuristic design and a strong, tempered blade. One side of the stainless steel blade is straight-edged, the other one is serrated right along the blade; they are both very sharp and effective for line cutting. The handle has an ergonomic design to ensure a secure grip even while wearing gloves. It is separated from the blade by a small techno-polymer thumb tab. The knife comes with a sheath that features a locking mechanism to allow one-hand release.

CODE	STYLE	CASE PACK
RC559100	Pointed Tip	10

<b>Blade length</b>	14,0 cm - 5 1/2 in
<b>Total length</b>	26,5 cm - 10 3/8 in
<b>Blade width</b>	25 mm - 1 in
<b>Blade thicknesses</b>	5 mm - 3/16 in
<b>Knife-only weight</b>	230 g - 8.1 oz
<b>Weight with sheath</b>	330 g - 11.6 oz

SPARE PARTS

CODE	PRODUCT
RZ550013	SHEATH for BORG KNIFE
RZ550018	STRAPS for KNIVES (PAIR)

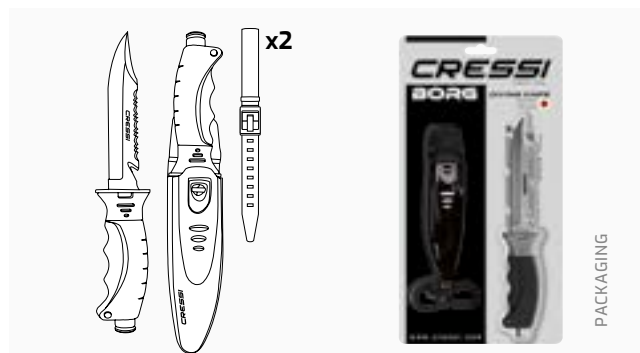

PACKAGING

# BORG



**304** JAPANESE  
STEEL

The Borg is a modern, large knife with a futuristic design and a strong, tempered blade. One side of the stainless steel blade is straight-edged, the other one is serrated right along the blade; they are both very sharp and effective for line cutting. The handle has an ergonomic design to ensure a secure grip even while wearing gloves. It is separated from the blade by a small techno-polymer thumb tab. The knife comes with a sheath that features a locking mechanism to allow one-hand release.

CODE	STYLE	CASE PACK
RC559150	Blunt Tip	10

<b>Blade length</b>	10,0 cm - 5 1/8 in
<b>Total length</b>	25,5 cm - 10,0 in
<b>Blade width</b>	25 mm - 1 in
<b>Blade thicknesses</b>	5 mm - 3/16 in
<b>Knife-only weight</b>	230 g - 8.1 oz
<b>Weight with sheath</b>	330 g - 11.6 oz

#### SPARE PARTS

CODE	PRODUCT
RZ550013	SHEATH for BORG KNIFE
RZ550018	STRAPS for KNIVES (PAIR)

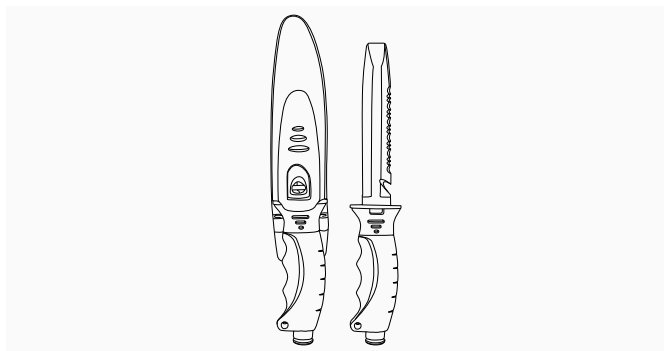

# NORGE

STAINLESS STEEL



Norge is a modern, compact knife with a futuristic design and a strong tempered blade. The anatomical, non-slip handle is made from soft grip material. It is separated from the blade by a small technopolymer thumb tab. The blade is made from special tempered stainless steel, with a smooth edge on one side and partly serrated on the other. This side of the blade has a line cutter at the handle end. The black technopolymer sheath comes with loops to attach it to leg or at the waist.

CODE	CASE PACK
RC553010	10

<b>Blade length</b>	11,7 cm - 4 5/8 in
<b>Total length</b>	22,8 cm - 9,0 in
<b>Blade width</b>	25 mm - 1 in
<b>Blade thicknesses</b>	4,5 mm - 3/16 in
<b>Knife-only weight</b>	140 g - 4.9 oz
<b>Weight with sheath</b>	250 g - 8.8 oz



PACKAGING

# PREDATOR

STAINLESS STEEL 420 + COATING

**420** JAPANESE  
420 STEEL

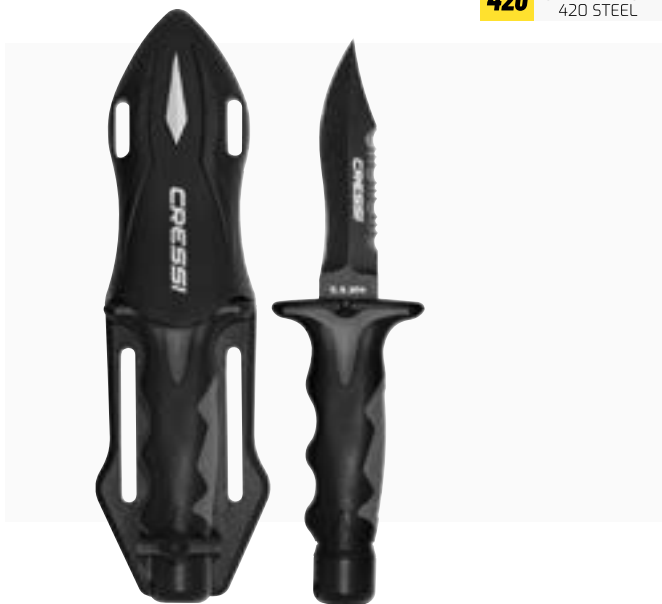

Predator is the evolution of the Killer model, designed to be the perfect finishing knife, very handy and anatomical. Its dimensions make it particularly suitable to be stored as a spare knife, or for divers who like to gear up in a practical and effective way.

CODE	CASE PACK
RC554500	10

<b>Blade length</b>	8,6 cm - 3 3/8 in
<b>Total length</b>	18,3 cm - 7 3/16 in
<b>Blade width</b>	17 mm - 21/32 in
<b>Blade thicknesses</b>	3-5 mm - 1/8-3/16 in
<b>Knife-only weight</b>	109 g - 3.8 oz
<b>Weight with sheath</b>	228 g - 8.0 oz

SPARE PARTS

CODE	PRODUCT
RZ550017	SHEATH for PREDATOR KNIFE
RZ550018	STRAPS for KNIVES (PAIR)



# KILLER

STAINLESS STEEL

MADE IN ITALY



A small knife that's been around for years now, highly appreciated because it is easy to handle and the blade penetrates really well. This is forged from a single piece of stainless steel, and is blocked at the grip by a screw knob situated at the end of the grip. One side of the blade has a smooth cutting edge, the other is partly serrated. The anatomical technopolymer grip ends at the blade with a thumb tab. The sheath is made from plastic and has a traditional elastic band to hold on the knife and loops to attach the knife to your leg or onto your belt.

CODE	CASE PACK
RC554000	10

<b>Blade length</b>	8,6 cm - 3 3/8 in
<b>Total length</b>	18 cm - 7 1/16 in
<b>Blade width</b>	25,2 mm - 1 in
<b>Blade thicknesses</b>	3-5 mm - 1/8 - 3/16 in
<b>Knife-only weight</b>	120 g - 4.2 oz
<b>Weight with sheath</b>	200 g - 7.1 oz



PACKAGING



# CHAKU

## SCUBA FOLDING KNIFE

MADE IN ITALY

Blade length 9.1 cms - 3.5 in  
 Total length 21 cms- 8.25 in  
 Folded length 12 cm - 4.7 in  
 Ultra high hardness



The Chaku Folding Knife is available in titanium or stainless steel. The titanium version is rust resistant, non-magnetic and requires minimal maintenance. When folded, the knife is only 4.7" (12 cm) and it can easily be stored in your pocket or be securely clipped to your BCD or harness with its slide locking lanyard. The overall length is 8.25" (21 cm) and the 3.5" (9.1 cm) blade has a line cutter with a spring-loaded safety lock, a partially serrated edge, and a sharp drop point tip. The Chaku handle is textured for a positive grip.

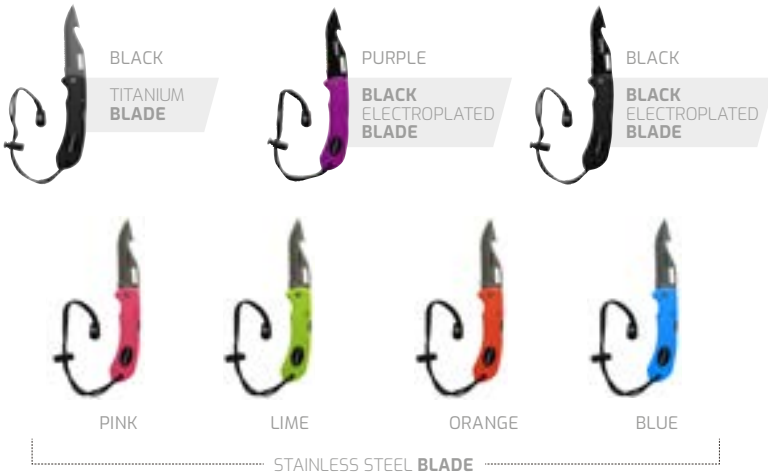

CODE	BLADE	STYLE
RC570020	Blue	Stainless Steel Blade
RC570040	Pink	Stainless Steel Blade
RC570044	Purple	Black Electroplated Blade
RC570050	Black	Black Electroplated Blade
RC570067	Lime	Stainless Steel Blade
RC570072	Black	Titanium Blade
RC570085	Orange	Stainless Steel Blade

PACKAGING



# GRIP

## SPEAR TITANIUM



The Grip Titanium is a small-sized knife with a titanium blade that lasts longer and is easy to use. It's rust-resistant and features a high-precision sharpened tip. One side is an extra-rigid serrated blade for sawing; the other side is a skillfully crafted straight blade. It features an ergonomic non-slip handle grip and a hole to add a lanyard (not included).

CODE	CASE PACK
RC559420	5

<b>Blade length</b>	74 cm - 2 15/16 in
<b>Total length</b>	174 cm - 6 7/8 in
<b>Knife-only weight</b>	35.4 g - 1.2 oz
<b>Weight with sheath</b>	80.7 g - 2.8 oz

### SPARE PARTS

CODE	PRODUCT
RZ550022	SHEATH FOR GRIP TITANIUM

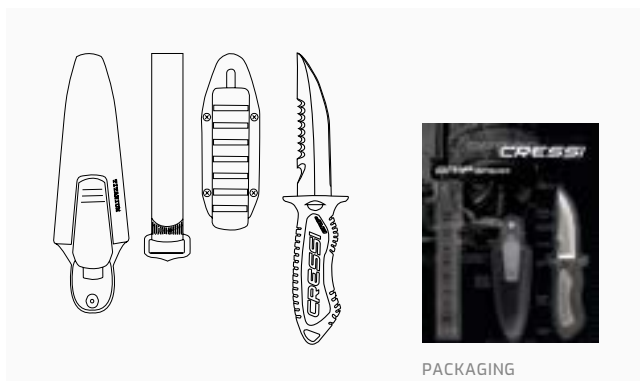

# GRIP

## SPEAR



The Grip Spear is a small-sized knife with a tapered blade that makes it ideal for spearfishing. The blade is made of stainless steel. It features a high-precision dagger point tip. One side is an extra-rigid serrated blade for sawing, the other side is a skillfully crafted straight blade. It features an ergonomic non-slip handle grip and a hole to add a lanyard (not included). The knife comes with a sheath that can be attached to the BCD shoulder strap.

CODE	CASE PACK
RC559400	5

<b>Blade length</b>	8,1 cm - 3 3/16 in
<b>Total length</b>	17,4 cm - 6 7/8 in
<b>Knife-only weight</b>	49 g - 1.7 oz
<b>Weight with sheath</b>	85 g - 3.0 oz

### SPARE PARTS

CODE	PRODUCT
RZ550021	SHEATH FOR GRIP SPEAR

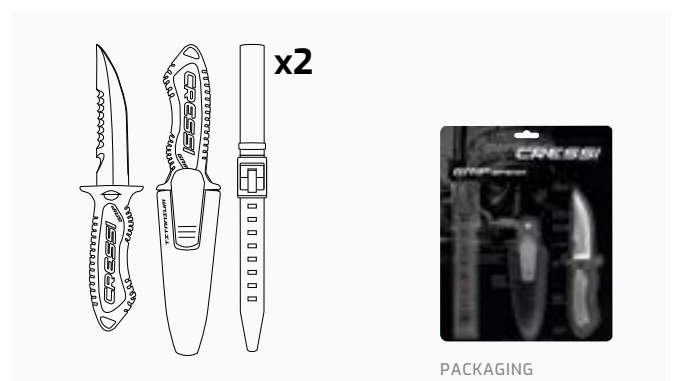

# GRIP

SPEAR BLACK

**420** JAPANESE  
420 STEEL



The Grip Spear Black is a small-sized knife with a special blade with two edges; ideal for any dives. The blade is made with the Japanese 420 Stainless Steel: strong and rust resistant. It features a high precision Dagger point tip. One side is an extra rigid serrated blade for sawing, the other side is a skillfully crafted straight blade. It features an ergonomic non-slip handle grip and a hole to add a lanyard (not included). The knife comes with a sheath that can be attached at the BCD shoulder strap. It has a Lock Mechanism that secures the knife. With 2 rubber straps (included) you can fix the sheath at your leg or at your arm.

CODE	CASE PACK
RC559430	5

<b>Blade length</b>	7,6 cm - 3.0 in
<b>Total length</b>	17,4 cm - 6 7/8 in
<b>Knife-only weight</b>	51 g - 1.8 oz
<b>Weight with sheath</b>	88 g - 3.1 oz

SPARE PARTS

CODE	PRODUCT
RZ550021	SHEATH FOR GRIP SPEAR

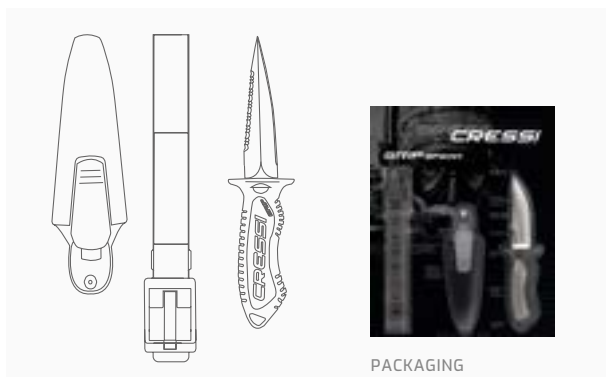

PACKAGING

# SKORPION

STAINLESS STEEL



Skorpion is a modern knife of last generation design and of medium dimensions, with a resistant tempered blade of tempered AISI 304 steel, with a smooth edge and a serrated edge with a wire cutter incorporated. The handle is anatomically shaped and made of "soft grip" material for a secure grip. It is separated from the blade by an integrated handguard made of technopolymer. Includes a pot in the same material as the leaf. The cover is made of black technopolymer and has straps for fixing to the thigh or belt. The knife comes with a sheath that features a locking mechanism to allow one-hand release. The sheath comes with two, standard issue straps to attach it to your leg.

CODE	STYLE
RC559000	Steel Blade
XRC569050	Black Blade

<b>Blade length</b>	11 cm - 4 5/16 in
<b>Total length</b>	23,2 cm - 9 1/8 in
<b>Blade width</b>	25,5 mm - 1 in
<b>Blade thickness</b>	5 mm - 3/16 in
<b>Knife-only weight</b>	200 g - 7.1 oz
<b>Weight with sheath</b>	280 g - 9.9 oz

SPARE PARTS

CODE	PRODUCT
RZ550014	SHEATH for SKORPION KNIFE
RZ550018	STRAPS for KNIVES (PAIR)



PACKAGING

# HAKA

NEW 2024

SCISSORS | 420 STAINLESS STEEL SCUBA TOOL

420 JAPANESE 420 STEEL



Machine serrated cutting edge for tearing through tough situations. Easy grip providing maximum mechanical leverage for cutting through even the toughest materials.

CODE	CASE PACK
RC580050	10

- 420 stainless steel
- Serrated cutting edge
- Multipurpose equipment
- Smooth cutting blade that is lightweight, but strong
- Heavy-duty construction
- Ultimate Cutting Edge



# VIGO

STAINLESS STEEL



Versatile knife featuring a blade made from stainless steel specifically made for the marine environment. Sheath with locking mechanism to allow one-hand release. The knife comes with two, standard issue straps to attach it to your leg.

CODE	CASE PACK
RC555000	10

Blade length	11,8 cm - 4 5/8 in
Total length	23,5 cm - 9 1/4 in
Blade width	25,2 mm - 1 in
Blade thickness	5 mm - 3/16 in
Knife-only weight	147 g - 5.2 oz
Weight with sheath	217 g - 7.6 oz



PACKAGING



# KNIVES

## SPARE PARTS

CODE	PRODUCT
RZ550003	SHEATH W/ STRAPS for ORCA
RZ550004	SHEATH W/ STRAPS for SUPERTOTEM
RZ550010	SHEATH for LAMA ARA KNIFE
RZ550012	SHEATH for LIMA KNIFE
RZ550013	SHEATH for BORG KNIFE
RZ550014	SHEATH for SKORPION KNIFE
RZ550015	SHEATH for GIANT KNIFE
RZ550016	SHEATH for FINISHER KNIFE
RZ550017	SHEATH for PREDATOR KNIFE
RZ550018	STRAPS for KNIVES (PAIR)
RZ550019	SHEATH FOR ALLIGATOR
RZ550020	SHEATH FOR GRIP BLUNT
RZ550021	SHEATH FOR GRIP SPEAR
RZ550022	SHEATH FOR GRIP TITANIUM
RZ551007	HOLDER for TOTEM/ORCA

### KNIVES COMPARISON CHART



PRODUCT	BLADE LENGTH	TOTAL LENGTH	BLADE WIDTH	BLADE THICKNESS	KNIFE-ONLY WEIGHT	WEIGHT WITH SHEATH
<b>ORCA</b>	17,8 cm 7.0 in	30 cm 11.82 in	32 mm 1.25 in	5,5 mm 0.22 in	450 g 15.9 oz	600 g 21.2 oz
<b>GIANT</b>	17,8 cm 7.0 in	30,0 cm 11.8 in	29,7 mm 1.1 in	5,2 mm 0.2 in	271 g 9.6 oz	429 g 15.1 oz
<b>FINISHER</b>	12,7 cm 5.0 in	24,7 cm 9.7 in	17 mm 0.67 in	3-5 mm 0.1-0.2 in	130 g 4.6 oz	200 g 7.1 oz
<b>BORG POINTED TIP</b>	14,0 cm 5.5 in	26,5 cm 10.4 in	25 mm 1 in	5 mm 0.19 in	230 g 8.1 oz	330 g 11.6 oz
<b>BORG BLUNT TIP</b>	13,0 cm 5.0 in	25,5 cm 5.0 in	25 mm 1 in	5 mm 0.19 in	230 g 8.1 oz	330 g 11.6 oz
<b>NORGE</b>	11,7 cm 4.6 in	22,8 cm 9.0 in	25 mm 1 in	4,5 mm 0.18 in	140 g 4.9 oz	250 g 8.8 oz
<b>LIZARD</b>	10,5 cm 4 1/8 in	21 cm 8 1/4 in	-	21 cm 8 1/4 in	-	-
<b>CHAKU</b>	9,1 cm 3.5 in	21 cm 8.25 in	-	-	-	-
<b>PREDATOR</b>	8,6 cm 3.4 in	18,3 cm 7.2 in	17 mm 0.67 in	3-5 mm 0.1-0.2 in	109 g 3.8 oz	228 g 8.0 oz
<b>KILLER</b>	8,6 cm 3.4 in	18 cm 7.1 in	25,2 mm 1 in	3-5 mm 0.1-0.2 in	120 g 4.2 oz	200 g 7.1 oz
<b>SNAKE</b>	8,1 cm 3 3/16 in	18,6 cm 7 5/16 in	-	21 cm 8 1/4 in	-	-
<b>GRIP POINT TIP</b>	8,1 cm 3.1 in	17,4 cm 6.8 in	n/a	n/a	49 g 1.7 oz	85 g 3.0 oz
<b>SKORPION</b>	11 cm 4.3 in	23,2 cm 9.1 in	25,5 mm 1 in	5 mm 0.18 in	200 g 7.1 oz	280 g 9.9 oz
<b>VIGO</b>	11,8 cm 4.6 in	23,5 cm 9.2 in	25,2 mm 1 in	5 mm 0.19 in	147 g 5.2 oz	217 g 7.6 oz

A woman with wet hair is smiling and looking to the right. She is holding a blue Cressi snorkel mask and a blue fin. The background is the ocean with a blue sky. A large blue diagonal shape is overlaid on the top left of the image.

## SNORKELING & BEACH LINE 2024 COLLECTION

Safety and comfort are key to having fun snorkeling, and Cressi's snorkeling gear has been designed with that in mind. Medium shades of tropical blue will reflect the brand personality of this line. Cressi's Snorkeling line is for those who love the shallow sea and exploring the reefs that are close to shore.

**CRESSI**





**SNORKELING & BEACH**



**ENJOY  
THE WATER**

# BARON & TONGA SET

BARON FULL FACE MASK + TONGA FINS



BLUE

BLACK

## TECHNICAL FEATURES

### FULL FACE MASK

- 30% larger viewing area
- The valvetless design gives the user effortless and natural breathing, with a wide and individual breathing chamber for nose and mouth.
- The face skirt is made of soft hypoallergenic silicone that gives comfort and a perfect seal.
- The two x-cross straps are easy to adapt for a perfect fit for your head.
- Frame and lens are made of polycarbonate material.

### FINS

- Open heel short blade
- Above blade foot pocket
- Adjustable strap length

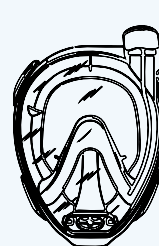

S/M 10 - 12 cm | 4 - 4.5 inch

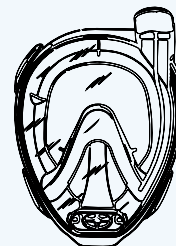

M/L > 11.5 cm | > 4.5 inch

## FIND YOUR DUKE IDEAL SIZE

MEASURE WITH THE RULER FROM THE BOTTOM OF THE CHIN TO THE EYELINE



CODE	COLOR	CASE PACK	MASK'S SIZE	FIN'S SIZE
SE010201	Clear/Blue-Blue	6	S/M	S/M
SE010202	Clear/Blue-Blue	6	S/M	L/XL
SE010204	Clear/Blue-Blue	6	M/L	L/XL
SE010501	Clear/Black-Black	6	S/M	S/M
SE010502	Clear/Black-Black	6	S/M	L/XL
SE010503	Clear/Black-Black	6	M/L	L/XL







Introducing *BLUE BY CRESSI*, the ultimate snorkeling line crafted specifically for snorkeling enthusiasts. Dive into a world of underwater wonders with confidence and ease, as our gear offers the perfect combination of quality and performance. *BLUE BY CRESSI* features a range of thoughtfully designed masks, ensuring a comfortable fit and an unobstructed view of the breathtaking marine life. The soft silicone skirt provides a leak-free seal, while the tempered glass lenses offer clarity and durability. Our snorkels, equipped with dry-top technology, keep water out and allow for effortless breathing. The purge valve ensures easy clearing, making it ideal for beginners.

**YOUR PASSPORT  
TO UNDERWATER  
EXPLORATION!**



# MUSA EXPLORER SET

NEW 2024

MUSA MASK + TONGA FINS + SCILLA SNORKEL



## TECHNICAL FEATURES

### MASK

- Frameless technology for maximum comfort
- Single tempered glass lens
- Wide field of view
- High-grade soft silicone
- Double feathered edge skirt
- Quick-adjustable strap buckles
- Easy-access nose pocket for 1-handed ear equalization

### SNORKEL

- Dry-top valve seals breathing tube when submerged
- Flexible lower bore reduces jaw fatigue
- Mouthpiece drops away when not in use great for scuba divers
- High-quality silicone mouthpiece is comfortable and durable
- Angled mouthpiece reduces jaw fatigue
- Lower purge valve allows water to be quickly expelled
- Streamlined design reduces drag while swimming
- Adjustable snorkel keeper for securing to any mask

### FINS

- Adult short adjustable snorkeling fins
- Adaptive and comfortable foot pocket made in rubber
- Adjustable strap length
- Short blade, ideal for travel
- Buckle specially designed to ensure robustness and long use



ROSE GOLD

BLACK

AQUA GREEN

CODE	COLOR [SIZE]	CASE PACK
SE234501	ROSE GOLD (S/M)	6
SE234502	ROSE GOLD (L/XL)	6
SE235501	BLACK (S/M)	6
SE235502	BLACK (L/XL)	6
SE236301	AQUA GREEN (S/M)	6
SE236302	AQUA GREEN (L/XL)	6

## TONGA FINS SIZE CHART

SIZE CONVERSION CHART				
FIN SIZE	EU FOOT SIZE	UK FOOT SIZE	US MEN FOOT SIZE	US WOMEN FOOT SIZE
S/M	36/41	3/7	4.5/8.5	5/9.5
L/XL	42/47	7.5/11.5	9/13	10/14

PRODUCT DIMENSION CHART				
A	B	C	D	POCKET HEIGHT
454 mm 17.9 in	182 mm 7.2 in	245 mm 10 in	105 mm 4.1 in	74 mm 2.9 in
468 mm 18.4 in	182 mm 7.2 in	259 mm 10.2 in	105 mm 4.1 in	74 mm 2.9 in

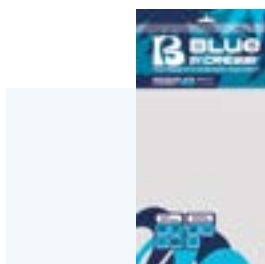
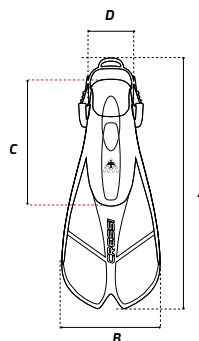

### MUSA SIZE CHART

**SKIRT SIZE**

WIDE Above 150mm (5 1/2 in) | REGULAR Between 110/140mm (4 1/2-5 1/2 in) | NARROW

**NOSE SIZE**

5 | 4 | 3 | 2 | 1

CRESSI'S SIZE CHART IS TO BE USED AS A REFERENCE ONLY

FINS COULD COME LABELED WITH EU AND UK SIZES ONLY CRESSI'S SIZE CHART TO BE USED AS A REFERENCE ONLY

### FITSIZE



TO MAXIMIZE PERFORMANCE AND COMFORT, WEAR FINN WITH:

<input checked="" type="checkbox"/>	<input checked="" type="checkbox"/>	<input type="checkbox"/>	<input type="checkbox"/>
BARE FOOT	NEOPRENE SOCKS	NEOPRENE BOOTS 3 mm + 5 mm + 7 mm	HARD SOLE BOOTS 3 mm + 5 mm + 7 mm

USA REV. 06/2023

# TINO ADVENTURE SET

NEW 2024

TINO MASK + TONGA FINS + SCILLA SNORKEL



## TECHNICAL FEATURES

### MASK

- Frameless technology for maximum comfort
- Single tempered glass lens
- Wide field of view
- High-grade soft silicone
- Double feathered edge skirt
- Quick-adjustable strap buckles
- Easy-access nose pocket for 1-handed ear equalization

### SNORKEL

- Dry-top valve seals breathing tube when submerged
- Flexible lower bore reduces jaw fatigue
- Mouthpiece drops away when not in use great for scuba divers
- High-quality silicone mouthpiece is comfortable and durable
- Angled mouthpiece reduces jaw fatigue
- Lower purge valve allows water to be quickly expelled
- Streamlined design reduces drag while swimming
- Adjustable snorkel keeper for securing to any mask

### FINS

- Adult short adjustable snorkeling fins
- Adaptive and comfortable foot pocket made in rubber
- Adjustable strap length
- Short blade, ideal for travel
- Buckle specially designed to ensure robustness and long use



CLEAR/BLUE NAVY    BLACK/ICE BLUE    BLACK/GRAPHITE

CODE	COLOR (SIZE)	CASE PACK
5E240271	CLEAR/BLUE NAVY (S/M)	6
5E240272	CLEAR/BLUE NAVY (L/XL)	6
5E245281	BLACK/ICE CYAN (S/M)	6
5E245282	BLACK/ICE CYAN (L/XL)	6
5E245571	BLACK/GRAPHITE (S/M)	6
5E245572	BLACK/GRAPHITE (L/XL)	6



## TONGA FINS CHART SIZE

SIZE CONVERSION CHART				
FIN SIZE	EU FOOT SIZE	UK FOOT SIZE	US MEN FOOT SIZE	US WOMEN FOOT SIZE
S/M	36/41	3/7	4.5/8.5	5/9.5
L/XL	42/47	7.5/11.5	9/13	10/14

PRODUCT DIMENSION CHART				
A	B	C	D	POCKET HEIGHT
454 mm 17.9 in	182 mm 7.2 in	245 mm 10 in	105 mm 4.1 in	74 mm 2.9 in
468 mm 18.4 in	182 mm 7.2 in	259 mm 10.2 in	105 mm 4.1 in	74 mm 2.9 in

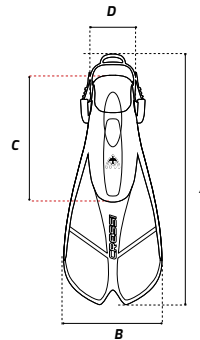

### TINO SIZE CHART

**A** | 124 mm - 4 1/2 in

**B** | 115 mm - 4 1/2 in

**C** | 130 mm - 1 1/8 in

**D** | 50 mm - 2 in

**SKIRT SIZE**

WIDE ——— REGULAR (Between 110/140mm [4 1/2-5 1/2 in]) ——— NARROW

**NOSE SIZE**

5 — 4 — 3 — 2 — 1

CRESSI'S SIZE CHART IS TO BE USED AS A REFERENCE ONLY

FINS COULD COME LABELED WITH EU AND UK SIZES ONLY. CRESSI'S SIZE CHART TO BE USED AS A REFERENCE ONLY.

USA REV. 06/2023

### FITSIZE



TO MAXIMIZE PERFORMANCE AND COMFORT, WEAR FIN WITH:

<input checked="" type="checkbox"/>	<input checked="" type="checkbox"/>	<input type="checkbox"/>	<input type="checkbox"/>
BARE FOOT	NEOPRENE SOCKS	NEOPRENE BOOTS 3 mm + 5 mm + 7 mm	HARD SOLE BOOTS 2 mm + 5 mm + 7 mm



# PALAU LAF SET

ONDA MASK + SUPERNOVA DRY SNORKEL + PALAU LAF FINN

PALAU LAF

T

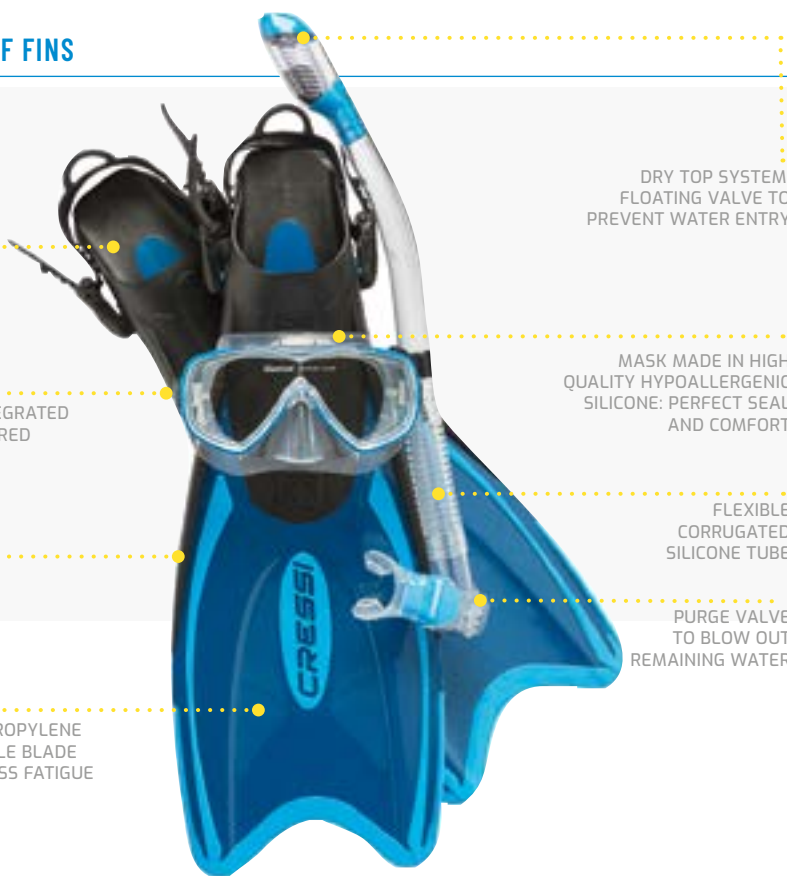

OPEN HEEL FOOT POCKET:

MASK FRAME INTEGRATED STRAP CLIP: ENSURED TOUGHNESS

POWER TRANSMISSION SIDE-RAILS

POLYPROPYLENE FLEXIBLE BLADE FOR LESS FATIGUE

DRY TOP SYSTEM: FLOATING VALVE TO PREVENT WATER ENTRY

MASK MADE IN HIGH QUALITY HYPOALLERGENIC SILICONE: PERFECT SEAL AND COMFORT

FLEXIBLE CORRUGATED SILICONE TUBE

PURGE VALVE TO BLOW OUT REMAINING WATER



The Palau Long Adjustable Fins (LAF) are open heel made for use with bare feet and provide outstanding comfort and versatility.

The Onda has a single tempered glass lens, and is designed for snorkeling, swimming and scuba diving. The Supernova Dry has a splash guard on the top that reduces the entrance of water during use on the surface. The top features a special valve that seals the tube when diving, even when the snorkel is submerged. A water collector, featuring a purge valve, allows quick and easy expulsion of water.

The Palau set includes a re-usable zip-up bag with a shoulder strap, perfect for travel and recreational use.

CODE	COLOR	CASE PACK	SIZE
SE102035	Blue	3	XS/S
SE102038	Blue	3	S/M
SE102041	Blue	3	M/L
SE102044	Blue	3	L/XL
SE104035	Pink	3	XS/S
SE104038	Pink	3	S/M
SE104041	Pink	3	M/L

## PALAU LAF CHART SIZE

SIZE CONVERSION CHART				
FIN SIZE	EU FOOT SIZE	UK FOOT SIZE	US MEN FOOT SIZE	US WOMEN FOOT SIZE
XS/S	35/38	2/4	4/6.5	5/7.5
S/M	38/41	4/7	6.5/8	7.5/9.5
M/L	41/44	7/10	9.5/11	9.5/12
XL	44/47	10/13	11/13	12/14

PRODUCT DIMENSION CHART			
A	B	C	D
515 MM 20.3 IN	195 MM 7.7 IN	248 MM 9.8 IN	99 MM 3.8 IN
535 MM 21.1 IN	200 MM 7.9 IN	258 MM 10.2 IN	100 MM 3.9 IN
550 MM 21.7 IN	205 MM 8.1 IN	265 MM 10.5 IN	103 MM 4 IN
560 MM 22.1 IN	210 MM 8.3 IN	269 MM 10.6 IN	105 MM 4.1 IN

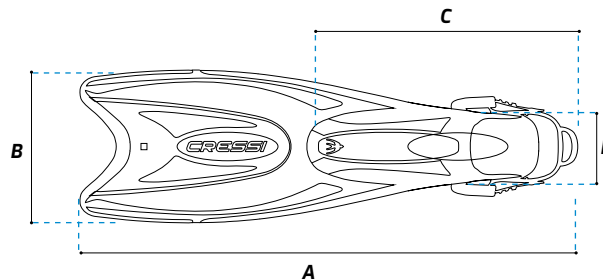

⚠️ FINN COULD COME LABELED WITH EU AND UK SIZES ONLY  
 CRESSI'S SIZE CHART TO BE USED AS A REFERENCE ONLY  
 USA REV. 06/2023

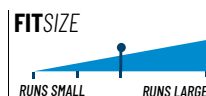

TO MAXIMIZE PERFORMANCE AND COMFORT, WEAR FINN WITH:

<input checked="" type="checkbox"/>	<input checked="" type="checkbox"/>	<input checked="" type="checkbox"/>	<input checked="" type="checkbox"/>
BARE FOOT	NEOPRENE SOCKS	NEOPRENE BOOTS 3 mm - 5 mm (1 mm)	HARD SOLE BOOTS 3 mm - 5 mm (1 mm)





# PALAU SAF SET

ONDA MASK + SUPERNOVA DRY SNORKEL + PALAU SAF FINS



OPEN HEEL FOOT POCKET:

MASK MADE IN HIGH QUALITY HYPOALLERGENIC SILICONE: PERFECT SEAL AND COMFORT

POWER TRANSMISSION SIDE-RAILS

DRY TOP SYSTEM: FLOATING VALVE TO PREVENT WATER ENTRY

EASY-TO-USE ROBUST BUCKLES

FLEXIBLE CORRUGATED SILICONE TUBE

PURGE VALVE TO BLOW OUT REMAINING WATER

# PALAU SAF

A true sports fin, the Palau SAF Set is ideal for active water sports enthusiasts. Short and easy to pack, it's the ultimate travel companion and is suitable for snorkeling, swimming, body surfing, boogie boards and much more.

The Palau Saf set includes a re-usable zip-up bag with a shoulder strap, perfect for travel and recreational use.

CODE	COLOR	CASE PACK	SIZE
SE202035	Blue	3	XS/M
SE202038	Blue	3	S/M
SE202041	Blue	3	M/L
SE202044	Blue	3	L/XL

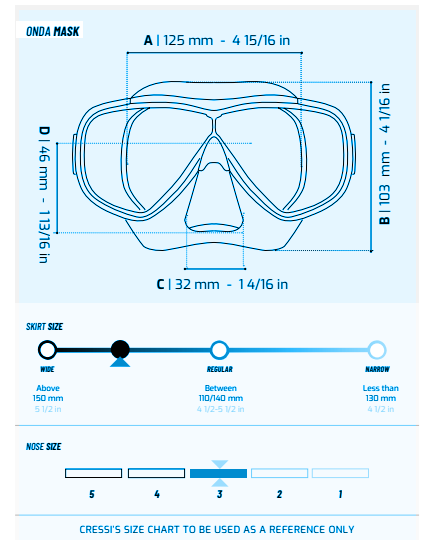

## PALAU SAF CHART SIZE

SIZE CONVERSION CHART				
FIN SIZE	EU FOOT SIZE	UK FOOT SIZE	US MEN FOOT SIZE	US WOMEN FOOT SIZE
XS/5	35/38	2/4	4/6.5	5/7.5
S/M	38/41	4/7	6.5/8	7.5/9.5
M/L	41/44	7/10	9.5/11	9.5/12
L/XL	44/47	10/13	11/13	12/14

PRODUCT DIMENSION CHART				
A	B	C	D	
402 MM 15.9 IN	191 MM 7.5 IN	248 MM 9.8 IN	97 MM 3.8 IN	
415 MM 16.4 IN	197 MM 7.7 IN	248 MM 9.8 IN	97 MM 3.8 IN	
427 MM 16.8 IN	202 MM 7.9 IN	258 MM 10.2 IN	100 MM 3.9 IN	
435 MM 17.2 IN	206 MM 8.1 IN	265 MM 10.4 IN	103 MM 4.1 IN	

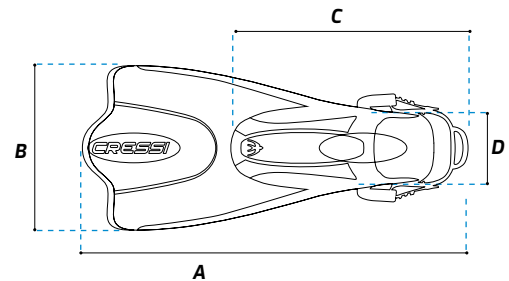

⚠️ FINS COULD COME LABELED WITH EU AND UK SIZES ONLY  
 CRESSI'S SIZE CHART TO BE USED AS A REFERENCE ONLY  
 USA REV. 06/2023

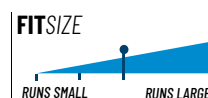

TO MAXIMIZE PERFORMANCE AND COMFORT, WEAR FINN WITH:

<input checked="" type="checkbox"/>	<input checked="" type="checkbox"/>	<input checked="" type="checkbox"/>	<input checked="" type="checkbox"/>
BARE FOOT	NEOPRENE SOCKS	NEOPRENE BOOTS 3 mm - 3 mm - 1 mm	HARD SOLE BOOTS 3 mm - 3 mm - 1 mm

# BONETE PRO DRY SET

IKARUS MASK + ORION DRY SNORKEL + BONETE PRO FINS



DOUBLE INJECTION PERSONALIZED STRAP



REDESIGNED BUCKLE SYSTEM. INCREASED STURDINESS AND LIFESPAN.



The Bonete Dry Set is a great all-around snorkel package for the next vacation. The tempered glass mask, the dry snorkel and the short fins, are transportable in a mesh bag. The bag makes it easy to carry, rinse, dry and store the set after use. It is a lightweight and practical set for those who have the desire to travel around the world to explore the underwater world.



NET BAG INCLUDED

CODE	COLOR	CASE PACK	SIZE
DM210261	Trans. Aqua.	10	S/M
DM210262	Trans. Aqua.	10	L/XL
DM210421	Trans. Pink	10	S/M
DM210422	Trans.Pink	10	L/XL







**FULL FACE**  
SNORKELING & BEACH

# DUKE

## WINDOW TO THE SEA



<b>180° field of vision</b>	Cressi Duke boasts a visual field that is 30% larger than normal full face masks
<b>Stop fogging</b>	The new baffle that Cressi has created optimizes air circulation, completely eliminating the fogging effect
<b>Safety valves</b>	Special safety valves allow you to easily purge water
<b>Natural breathing</b>	Ample front area lets you breathe naturally through your nose and mouth with 0% effort
<b>Dry Snorkel</b>	The snorkel features a special Dry System that keeps water out of the tube
<b>High quality</b>	Cressi Duke is made using extremely high quality materials and technology. Cressi provides a convenient carrying bag
<b>Size</b>	Available in S/M and M/L. To check the correct size, use a ruler to measure from the chin to the eye line
<b>#cressievolution</b>	Cressi Duke is the evolution of the first full face mask ever produced, called the Medusa, made in 1946

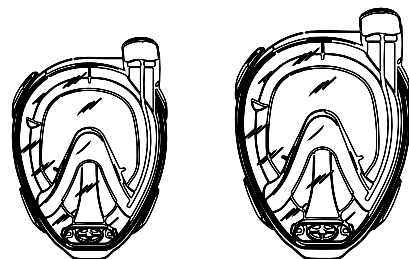

**S/M**  
10-12 cm / 4-4.5 in

**M/L**  
>11.5 cm / >4.5 in

### FIND YOUR IDEAL SIZE

MEASURE WITH THE RULER FROM THE BOTTOM OF THE CHIN TO THE EYELINE



CLEAR/YELLOW

CLEAR/BLUE

CLEAR/AQUAMARINE

CLEAR/PINK

BLACK/BLACK

CODE	COLOR	SIZE
XDT000010	Clear/Yellow	S/M
XDT000020	Clear/Blue	S/M
XDT000026	Clear/Translucent Aquamarine	S/M
XDT000041	Clear/Translucent Pink	S/M
XDT005050	Black/Black	S/M
XDT010010	Clear/Yellow	M/L
XDT010020	Clear/Blue	M/L
XDT010026	Clear/Translucent Aquamarine	M/L
XDT010041	Clear/Translucent Pink	M/L
XDT015050	Black/Black	M/L

### SPARE PARTS

CODE	PRODUCT
XDZ500001	Duke dry complete snorkel - clear/grey
XDZ500002	Duke dry complete snorkel - black/grey
XDZ500009	Duke dry mouthpiece cover - black
XDZ500010	Duke dry mouthpiece cover - grey
XDZ500011	Duke dry strap - black-white/silver
XDZ500012	Valves kit for duke

### WALL DISPLAYS FOR FULL FACE AND DIVE MASKS AVAILABLE





# BARON

WINDOW TO THE SEA



## TECHNICAL FEATURES

- 30% larger viewing area
- The valveless design gives the user effortless and natural breathing, with a wide and individual breathing chamber for nose and mouth
- The face skirt is made of soft hypoallergenic silicone that gives comfort and a perfect seal
- The two x-cross straps are easy to adapt for a perfect fit for your head
- Frame and lens are made of polycarbonate material

The Baron is the version of Duke with a different case pack (cardboard box instead of the reusable bag) and a more simplified aesthetics, but with identical features that differentiate it from other face masks on the market.

The Duke-Baron project has required in-depth studies of the design and circulation of both inlet and exhaust air, in order to solve the usual problems in these masks in competing models and make the Cressi face mask especially safe in any situation. The valveless design guarantees a large supply flow,

unthinkable in other similar models, especially in case of fatigue or stress. The evacuation of the exhalation is channeled in separated ductwork that prevents the accumulation of carbon monoxide in the breathing zone.

The air circulation in Baron is clearly superior to that of any other mask on the market. Tested in the laboratory of the Engineering Department of the Milan Polytechnic, where the results exceeded any expectations.

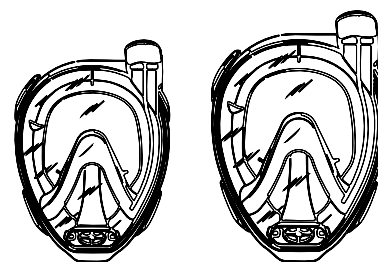

S/M  
10-12 cm / 4-4.5 in

M/L  
>11.5 cm / >4.5 in

## FIND YOUR IDEAL SIZE

MEASURE WITH THE RULER FROM THE BOTTOM OF THE CHIN TO THE EYELINE



CODE	COLOR	SIZE	CASE PACK
XDT020000	Clear/Clear	S/M	6
XDT020020	Clear/Blue	S/M	6
XDT020025	Clear/Aquamarine	S/M	6
XDT020050	Clear/Black	S/M	6
XDT025050	Black/Black	S/M	6
XDT030000	Clear/Clear	M/L	6
XDT030020	Clear/Blue	M/L	6
XDT030025	Clear/Aquamarine	M/L	6
XDT030050	Clear/Black	M/L	6
XDT035050	Black/Black	M/L	6

## WALL DISPLAYS

FOR FULL FACE AND DIVE MASKS AVAILABLE



# KNIGHT

ADULT FULL FACE MASK

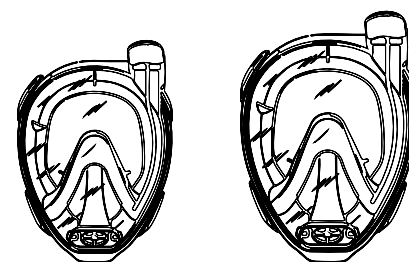

S/M  
10-12 CM / 4-4.5 INCH

M/L  
>11.5 CM / >4.5 INCH

Designed with the highest quality materials and technology. It lets you explore the marine world by breathing naturally through the nose and mouth with zero effort. Its field of view is approximately 30% larger than common full face masks.

The air deflector completely eliminates fogging. It is equipped with special safety valves for draining the water. The snorkel has a special dry system that prevents water entering.

CODE	COLOR	CASE PACK	SIZE
XDT042022	Ligth Blue/Dark Blue	6	S/M
XDT052022	Ligth Blue/Dark Blue	6	M/L

### FIND YOUR DUKE IDEAL SIZE

MEASURE WITH THE RULER FROM THE BOTTOM OF THE CHIN TO THE EYELINE



**WALL DISPLAYS**  
FOR FULL  
FACE AND DIVE  
MASKS  
**AVAILABLE**





COMBOS  
SNORKELING & BEACH

# F-DUAL & TAO DRY

NEW  
2024

F-DUAL MASK + TAO DRY SNORKEL

### TECHNICAL FEATURES

**· MASK**

- Frameless technology for maximum comfort
- Single tempered glass lens
- Wide field of view
- High-grade soft silicone
- Double feathered edge skirt
- Quick-adjustable strap buckles
- Easy-access nose pocket for 1-handed ear equalization

**· SNORKEL**

- Dry-top valve seals breathing tube when submerged
- Flexible lower bore reduces jaw fatigue
- Mouthpiece drops away when not in use great for scuba divers
- High-quality silicone mouthpiece is comfortable and durable
- Angled mouthpiece reduces jaw fatigue
- Lower purge valve allows water to be quickly expelled
- Streamlined design reduces drag while swimming
- Adjustable snorkel keeper for securing to any mask



PACKAGING



## F-DUAL & TAO DRY



TURQUOISE/CLEAR



BLACK/BLACK



CLEAR/PINK FLUO

CODE	COLOR
DM410040	F-DUAL & TAO DRY COMBO - CLEAR/PINK FLUO
DM410045	F-DUAL & TAO DRY COMBO - CLEAR/TURQUOISE
DM415050	F-DUAL & TAO DRY COMBO - BLACK/BLACK



# F-DUAL & SUPERNOVA DRY

F-DUAL MASK + SUPERNOVA DRY SNORKEL



CLEAR/BLUE

BLACK/BLUE

BLACK/WHITE

CODE	COLOR
DM330020	Clear/Blue
DM335020	Black/Blue
DM335030	Black/White - Black/Black



## TECHNICAL FEATURES

### MASKS

- Frameless technology for maximum comfort
- Single tempered glass lens
- Wide field of view
- High-grade soft silicone
- Double feathered edge skirt
- Quick-adjustable strap buckles
- Easy-access nose pocket for 1-handed ear equalization

### SNORKEL

- Dry-top valve seals breathing tube when submerged
- Flexible lower bore reduces jaw fatigue
- Mouthpiece drops away when not in use great for scuba divers
- High-quality silicone mouthpiece is comfortable and durable
- Angled mouthpiece reduces jaw fatigue
- Lower purge valve allows water to be quickly expelled
- Streamlined design reduces drag while swimming
- Adjustable snorkel keeper for securing to any mask

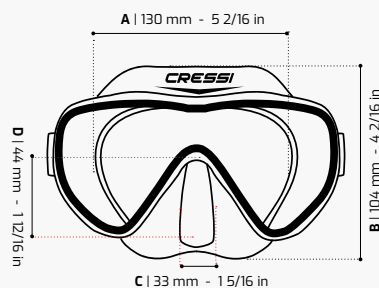

### PROFILE VIEW



### SKIRT SIZE



### NOSE SIZE

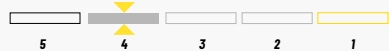

CRESSI'S SIZE CHART TO BE USED AS A REFERENCE ONLY



PACKAGING



# MUSA & SCILLA

NEW 2024



AQUA/GREEN

BLACK

ROSE GOLD



CODE	COLOR	CASE PACK
DM426363	AQUA GREEN	12
DM425050	BLACK	12
DM426161	ROSE GOLD	12

## TECHNICAL FEATURES

- MASK**
  - Frameless technology for maximum comfort
  - Single tempered glass lens
  - Wide field of view
  - High-grade soft silicone
  - Double feathered edge skirt
  - Quick-adjustable strap buckles
  - Easy-access nose pocket for 1-handed ear equalization
- SNORKEL**
  - Dry-top valve seals breathing tube when submerged
  - Flexible lower bore reduces jaw fatigue
  - Mouthpiece drops away when not in use great for scuba divers
  - High-quality silicone mouthpiece is comfortable and durable
  - Angled mouthpiece reduces jaw fatigue
  - Lower purge valve allows water to be quickly expelled
  - Streamlined design reduces drag while swimming
  - Adjustable snorkel keeper for securing to any mask

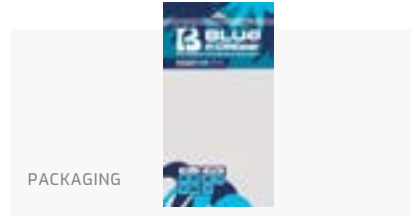

PACKAGING

# TINO & SCILLA

NEW 2024



BLACK/GRAPHITE

CLEAR/BLUE NAVY

BLACK/ICE BLUE

CODE	COLOR	CASE PACK
DM435072	Black/Graphite	12
DM430020	Clear/Blue Navy	12
DM435028	Black/Ice Cyan	12

## TECHNICAL FEATURES

- MASK**
  - Frameless technology for maximum comfort
  - Single tempered glass lens
  - Wide field of view
  - High-grade soft silicone
  - Double feathered edge skirt
  - Quick-adjustable strap buckles
  - Easy-access nose pocket for 1-handed ear equalization
- SNORKEL**
  - Dry-top valve seals breathing tube when submerged
  - Flexible lower bore reduces jaw fatigue
  - Mouthpiece drops away when not in use great for scuba divers
  - High-quality silicone mouthpiece is comfortable and durable
  - Angled mouthpiece reduces jaw fatigue
  - Lower purge valve allows water to be quickly expelled
  - Streamlined design reduces drag while swimming
  - Adjustable snorkel keeper for securing to any mask

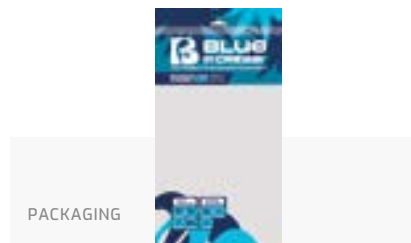

PACKAGING

# IKARUS & ORION DRY

## IKARUS MASK + ORION DRY SNORKEL

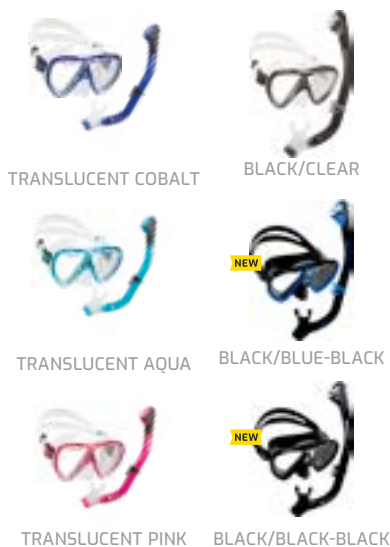

The Ikarus & Orion Dry combo is a lightweight equipment great for travelers that want to discover the underwater world. Both mask and snorkel have parts made with soft and hypoallergenic silicone to ensure comfort and ease of use. The mask has a silicone skirt to ensure comfort and a perfect seal. Thanks to the adjustable buckles, it is possible to

adjust the length of the silicone strap. The lenses are made in tempered glass. The snorkel features a special valve on the top that seals the tube when submerged. The mouthpiece is made in soft silicone for avoiding jaw fatigue. At the bottom, a purge valve makes it easy to purge the water from the snorkel.

CODE	COLOR	CASE PACK
DM232121	Translucent Cobalt	12
DM232626	Translucent Aqua.	12
DM234242	Translucent Pink	12
DM235000	Black/Clear	12
<b>NEW</b> DM235520	Black/Blue-Black	12
<b>NEW</b> DM235550	Black/Black-Black	12

### TECHNICAL FEATURES

**MASKS**

- Silicone skirt
- Tempered glass
- Buckle strap
- Length adjustment

**SNORKEL**

- Top dry valve (Orion dry)
- Splash guard top
- Bottom purge valve
- Silicone mouthpiece

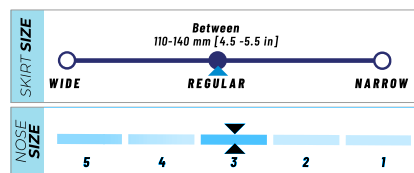
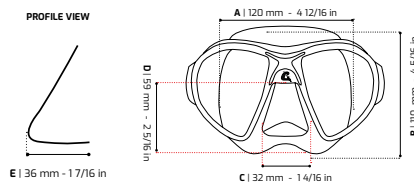

### PRODUCT DIMENSION CHART (SKIRT SIZE)

A - WIDTH	B - HEIGHT	C - NOSE LENGTH	D - NOSE HEIGHT	E - NOSE WIDTH
120 mm	110 mm	32 mm	59 mm	36 mm
4 12/16 in	4 5/16 in	1 4/16 in	2 5/16 in	1 7/16 in

Cressi's Size Chart is to be used as a reference only  
 ++ Measure ear to ear with a ruler

# IKARUS & ORION

## IKARUS MASK + ORION SNORKEL



CODE	COLOR	CASE PACK
DM245010	Black/Yellow	12
DM245020	Black/Blue	12
DM245040	Black/Pink	12
<b>NEW</b> DM245555	Black/Black-Black	12



# ONDA & MEXICO

## ONDA MASK + MEXICO SNORKEL



CLEAR  
YELLOW



CLEAR  
BLUE



CLEAR  
PINK



BLACK  
BLACK

### TECHNICAL FEATURES

#### MASKS

- 100% high quality silicone skirt
- Single tempered glass
- Easy adjustable buckles

#### SNORKEL

- Splash guard
- Silicone mouthpiece

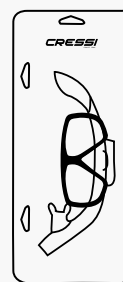

The Onda & Mexico combines two light products for easy exploration of the underwater world. The mask offers a large view thanks to the single lens. The snorkel has a splash guard, allowing the snorkeler to worry less about water entry.

CODE	COLOR	CASE PACK
DM1010151	Clear/Yellow	10
DM1010152	Clear/Blue	10
DM1010154	Clear/Pink	10
DM1010155	Black/Black	10

# TINO & ISLAND 2.0

NEW  
2024

## TINOS MASK + ISLAND 2.0 SNORKEL

The Tino & Island 2.0 combo suits both novice and experienced snorkelers. The Tino mask has a broad teardrop-shaped tempered glass lens for clear underwater vision, a hypoallergenic silicone skirt with a dual-edge seal for comfort, and an adjustable split strap. The Island 2.0 boasts a streamlined tube and a flexible, easy-to-clear mouthpiece for comfort during extended use, a wide diameter tube for unhindered breathing, and a secure fixed keeper to prevent loss while snorkeling.



CODE	COLOR	CASE PACK
DM445050	BLACK/BLACK	12



# MASKS

SNORKELING & BEACH

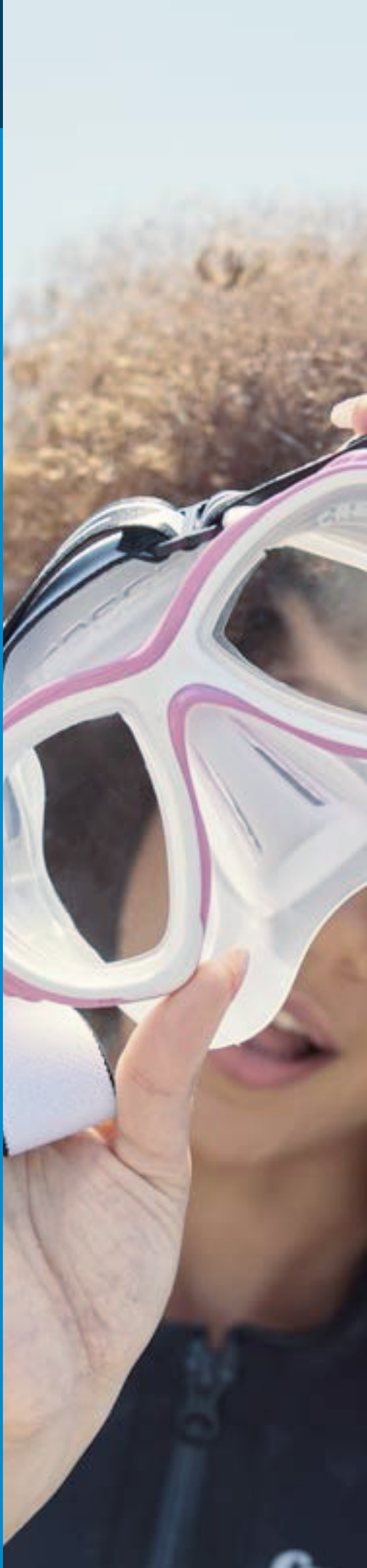

SNORKELING & BEACH \_ MASKS \_ F1

# F1

100%  
HIGH  
QUALITY

SOFT SILICONE  
SHINY

MADE IN ITALY

FRAMELESS



The F1 masks are loved by many divers for their low-profile and ability to fold flat for easy carrying, even in a BC pocket. Cressi's frameless design bonds a high-grade silicone skirt directly to a single lens for the ultimate in simplicity. The low-internal volume allows for effortless clearing and quick-adjust strap buckles are molded directly into the skirt for a flexible fit and reduced drag. It also represents an unbeatable value, with a cost roughly half that of similar masks.



CLEAR



WHITE



PINK

CODE	COLOR	CASE PACK
ZDN281000	Clear	10
ZDN283000	White	10
ZDN284000	Pink	10



# F-DUAL NEW 2024

## MONO-LENS FRAMELESS DIVE MASK



### TECHNICAL FEATURES

- Frameless technology for maximum comfort
- Single tempered glass lens
- Wide field of view
- High-grade soft silicone
- Double feathered edge skirt
- Quick-adjustable strap buckles
- Easy-access nose pocket for 1-handed ear equalization the face

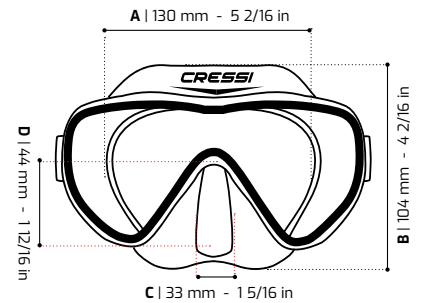

### PROFILE VIEW

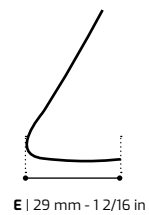

The F-Dual is a single-lens mask featuring a unique assembly of lens and skirt without a frame. The mask design bonds a high-grade silicone double-feathered edge skirt directly to a single tempered glass lens for the ultimate in simplicity. The silicone facial is assembled directly on the glass without the need for a frame. This system guarantees good visibility in all directions. The low internal volume allows for effortless clearing and the quick-adjust strap buckles are molded directly into the skirt for a flexible fit and reduced drag. The F-Dual mask has a wide split strap design for comfort and to give even-tension on the skirt for a proper seal.

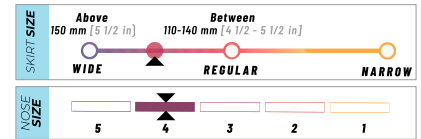

### PRODUCT DIMENSION CHART (SKIRT SIZE)

A - WIDTH	B - HEIGHT	C - NOSE LENGTH	D - NOSE HEIGHT	E - NOSE WIDTH
130 mm 5 2/16 in	104 mm 4 2/16 in	33 mm 1 5/16 in	44 mm 1 12/16 in	29 mm 1 2/16 in

CRESSI'S SIZE CHART IS TO BE USED AS A REFERENCE ONLY



BLUE NAVY



BLACK

**YELLOW/BLUE**  
LENSES  
80% UV-ANTI GLARE



BLACK

**BLUE/ORANGE**  
LENSES  
80% UV



### COATED LENSES

FEATURES DETAILS  
Pag 141



PACKAGING

CODE	COLOR	CASE PACK
<b>NEW</b> D5502020	BLUE NAVY	30
<b>NEW</b> D5505951	BLACK/BLACK - UV420 YELLOW LENS	30
<b>NEW</b> D5505952	BLACK/BLACK - UV420 BLUE LENS	30

### SPARE PARTS

CODE	PRODUCT
DZ222050	STRAP for SCUBA MASK TW - BLACK
DZ221050	BUCKLES for SCUBA MASK TW - BLACK/BLACK

# MAREA



## TECHNICAL FEATURES

- Tempered glass
- Small inner volume
- Micrometric adjustable buckles
- Reinforced frame

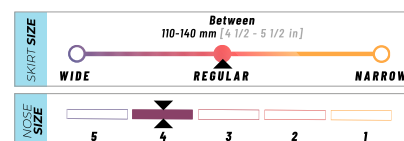
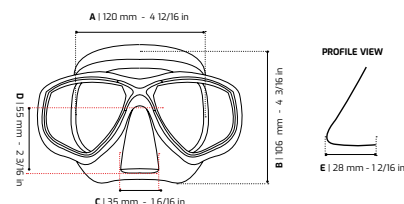

The Marea is made in 100% silicone to ensure comfort and a perfect seal. It is a multi-use mask suitable both for use on the surface and in depth thanks to the small inner volume and to the soft nose pocket to compensate for air pressure. A mask particularly suitable for freediving and snorkeling, but just as appropriate for use in scuba diving. It has separate lenses, a skirt edge that adapts to most faces and a small inner volume, perfect for freedivers. It is made from soft silicone and comes with strong rapid action buckles to adjust the strap.



### PRODUCT DIMENSION CHART (SKIRT SIZE)

A - WIDTH	B - HEIGHT	C-NOSE LENGTH	D-NOSE HEIGHT	E-NOSE WIDTH
120 mm	106 mm	35 mm	55 mm	28 mm
4 12/16 in	4 3/16 in	1 6/16 in	2 3/16 in	1 2/16 in

Cressi's Size Chart is to be used as a reference only  
 ++ Measure ear to ear with a ruler



2024 - CATALOG

CODE	COLOR	CASE PACK
DN281010	Clear/Yellow	12
DN281020	Clear/Blue	12
DN281040	Clear/Pink	12
DN281060	Clear/Black	12
DN285050	Black/Black	12

### SPARE PARTS

CODE	PRODUCT
DZ210020	Buckles - Black for Estrella/Marea/Marea Jr/Sky
DZ210040	Silicone Strap - Clear for Sea Line Masks
DZ210042	Silicone Strap - Black for Sea Line Masks



# PERLA



A mask particularly suitable for freediving and snorkeling, but just as appropriate for use in scuba diving. It has separate lenses, a skirt edge fitting most of the faces and a small inner volume, perfect for freedivers. It is made from soft transparent or dark silicone for a better comfort and a perfect seal. It comes with strong rapid action buckles to adjust the length strap.



CLEAR/CLEAR/  
BLUE

CLEAR/CLEAR/  
PINK

CLEAR/CLEAR/  
BLACK

CLEAR/CLEAR/  
AQUA.

BLACK/BLACK

CLEAR/CLEAR

CODE	COLOR	CASE PACK
DN207920	Clear/Clear/Blue	12
DN207940	Clear/Clear/Pink	12
DN207950	Clear/Clear/Black	12
DN207963	Clear/Clear/Aquamarine	12
DN208060	Clear/Clear	12
DN208150	Black/Black	12

SPARE PARTS

CODE	PRODUCT
DZZ10020	Buckles - Black for Estrella/Marea/Marea Jr/Sky
DZZ10040	Silicone Strap - Clear for Sea Line Masks
DZZ10042	Silicone Strap - Black for Sea Line Masks

## TECHNICAL FEATURES

- Tempered glass
- Small inner volume
- Micrometric adjustable buckles
- Reinforced frame
- Pressure buckles for instant adjustment

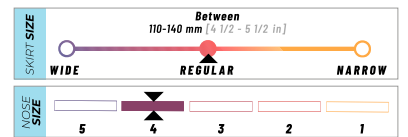
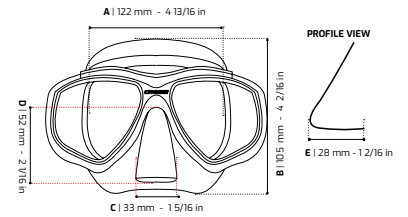

### PRODUCT DIMENSION CHART (SKIRT SIZE)

A - WIDTH	B - HEIGHT	C - NOSE LENGTH	D - NOSE HEIGHT	E - NOSE WIDTH
122 mm	105 mm	33 mm	52 mm	28 mm
4 13/16 in	4 2/16 in	1 5/16 in	2 1/16 in	1 2/16 in

Cressi's Size Chart is to be used as a reference only



# PERLA



# ONDA

100% HIGH QUALITY SOFT SILICONE CLEAR

MADE IN ITALY



## TECHNICAL FEATURES

- Single tempered glass lens
- Silicone skirt and strap



2024 - CATALOG

This mask has a single tempered glass lens, and is designed for snorkeling, swimming and scuba diving. The skirt is made from soft hypoallergenic transparent silicone.

The visibility provided by the single lens and the unusual shape of the frame extends in all directions. Excellent seal on many face types, average internal volume. Quick-release strap buckles.

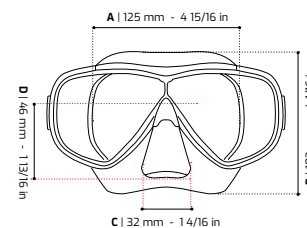

### PROFILE VIEW

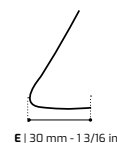

CLEAR/YELLOW



CLEAR/BLUE



CLEAR/PINK



BLACK

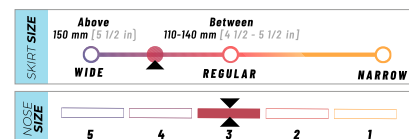

CODE	COLOR	CASE PACK
DN207010	CLEAR/YELLOW	12
DN207020	CLEAR/BLUE	12
DN207040	CLEAR/PINK	12
DN207150	BLACK/BLACK	12

### PRODUCT DIMENSION CHART (SKIRT SIZE)

A - WIDTH	B - HEIGHT	C-NOSE LENGTH	D-NOSE HEIGHT	E-NOSE WIDTH
125 mm 4 15/16 in	103 mm 4 1/16 in	32 mm 1 4/16 in	46 mm 1 13/16 in	30 mm 1 3/16 in

Cressi's Size Chart is to be used as a reference only



### SPARE PARTS

CODE	PRODUCT
DZ210020	BUCKLES - BLACK FOR ESTRELLA/MAREA/MAREA JR/SKY
DZ210040	SILICONE STRAP - CLEAR FOR SEA LINE MASKS
DZ210042	SILICONE STRAP - BLACK FOR SEA LINE MASKS

CRESSI



# SIRENA



IDEAL FOR RENTAL

**100%** HIGH QUALITY SOFT SILICONE

MADE IN ITALY

This mask has a single tempered glass lens, and is designed for snorkelling, swimming and scuba diving. The skirt is made from soft hypoallergenic transparent or black silicone. The visibility provided by the single lens and the unusual shape of the frame extends in all directions. Excellent seal on most face types. Average internal volume. It has quick-release strap buckles.

CODE	COLOR	CASE PACK
DN202000	Black/Black	12

SPARE PARTS

CODE	PRODUCT
DZ210005	Buckles - Black (Pair) for Ondina/Onda/Piumetta/Sirena
DZ210042	Silicone Strap - Black for Sea Line Masks

## TECHNICAL FEATURES

- Pressure buckles for instant adjustment
- Single tempered glass lens ensures excellent field of view
- Double edge skirt to ensure a great seal

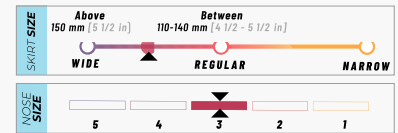
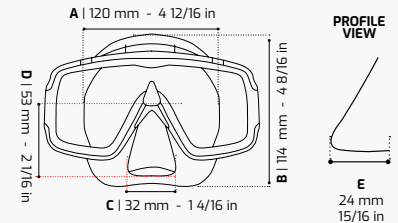

Cressi's Size Chart is to be used as a reference only



# MUSA

NEW 2024



**BLUE BY CRESSI**



AQUA GREEN

BLACK

ROSE GOLD

Single-lens mask featuring a unique assembly of lens and skirt without a frame. Cressi's Musa Design Bonds a High-Grade Silicone Double Feathered Edge Skirt directly to a Single Tempered Glass Lens for the Ultimate in Simplicity. Colorful frameless technology. The silicone facial is assembled directly on the glass without the need for a frame. This

system guarantees good visibility in all directions. The Low Internal Volume allows for effortless clearing and the Quick-Adjust Strap Buckles are molded directly into the Skirt for a Flexible Fit and Reduced Drag. The Cressi Musa has a Wide Split Mask Strap Design for Comfort and to give Even-Tension on the Skirt for a Proper Seal.

CODE	COLOR
DN326363	AQUA GREEN
DN325050	BLACK
DN326161	ROSE GOLD

## TECHNICAL FEATURES

- Frameless technology for maximum comfort
- Single tempered glass lens
- Wide field of view
- High-grade soft silicone
- Double feathered edge skirt
- Quick-adjustable strap buckles
- Easy-access nose pocket for 1-handed ear equalization on the face

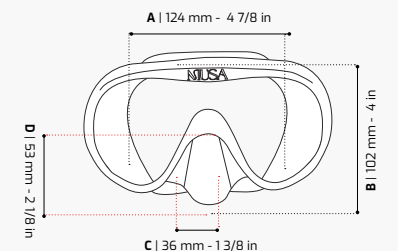

Cressi's Size Chart is to be used as a reference only

# TROPICAL



IDEAL FOR RENTAL

## TECHNICAL FEATURES

- Reinforced frame
- Black silicone version for rental
- Universal strap size
- Easy to identify as rental among other mask
- Bulk case packing available

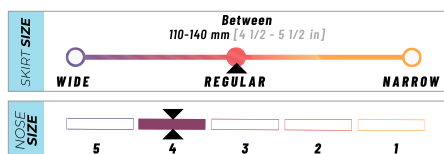
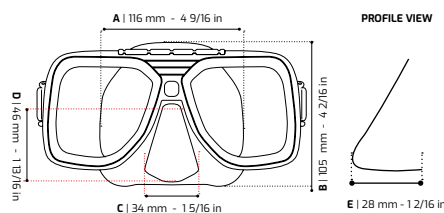

CRESSI'S SIZE CHART IS TO BE USED AS A REFERENCE ONLY



CODE	COLOR	CASE PACK
US401001	BLACK/BLACK	10
US401002	CLEAR/BLUE	10
US401003	BLACK/SILVER	10

### SPARE PARTS

CODE	PRODUCT
UZ401001	MASK STRAP + RETAINERS- BLACK
UZ401002	MASK STRAP + RETAINERS- CLEAR



# PACIFICO

100% HIGH QUALITY

SOFT SILICONE  
**BLACK**

## TECHNICAL FEATURES

- Single lens in a classic retro oval shape
- Scratch resistant tempered glass for clarity and safety
- Rubber skirt and strap for great seal and comfort
- Easily adjustable buckles

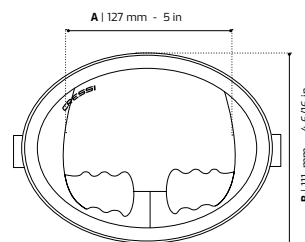

### PRODUCT DIMENSION CHART (SKIRT SIZE)

A - WIDTH	B - HEIGHT	A - WIDTH	B - HEIGHT
127 mm	111 mm	5 in	4 6/16 in

**RUBBER MASK**



CODE	CASE PACK
ZDN320050	10



**CRESSI**



**SNORKELS**  
SNORKELING & BEACH



# ALPHA ULTRA DRY

## DRY TOP | PURGE VALVE

It uses the latest dry-top snorkel technology with a compact valve that automatically closes to keep water out regardless of the angle of the snorkel. The Alpha also has a new, highly flexible tube that reduces jaw fatigue and folds compactly for storing in a BC pocket or travel pack. A new, wider elliptical shape increases air flow capacity for more comfortable breathing, while the purge valve enables instant clearing.



BLUE/  
AZURE

BLACK/  
YELLOW

BLACK/  
PINK

WHITE/  
LILAC



BLACK/  
SILVER

BLACK/WHITE/  
BLACK/

BLACK/BLACK/  
BLACK



CODE	COLOR	CASE PACK
ES258020	BLUE/AZURE/CLEAR	6
ES258041	WHITE/LILAC/CLEAR	6
ES258051	BLACK/YELLOW/CLEAR	6
ES258054	BLACK/PINK/CLEAR	6
ES258055	BLACK/SILVER/CLEAR	6
ES258130	BLACK/WHITE/BLACK	6
ES258150	BLACK/BLACK/BLACK	6

### SPARE PARTS

CODE	PRODUCT
E2267015	SNORKEL KEEPER for ALPHA ULTRA DRY/BETA - GREY
E2270017	MOUTHPIECE for ALPHA/BETA/CORFU/ITACA - BLACK
E2270019	MOUTHPIECE for ALPHA/BETA/CORFU/ITACA - CLEAR



### TECHNICAL FEATURES

- Dry Valve technology seals breathing tube when submerged at any angle
- Flexible tube allows folding for storage
- Mouthpiece drops away when not in use: great for scuba divers
- Angled mouthpiece reduces jaw fatigue
- Lower purge valve allows any water to be quickly expelled
- Streamlined design reduces drag while swimming
- Adjustable snorkel keeper for securing to any mask

ULTRA  
FLEXIBLE  
TUBE



ANGLE DRY  
PROTECTION  
TECHNOLOGY

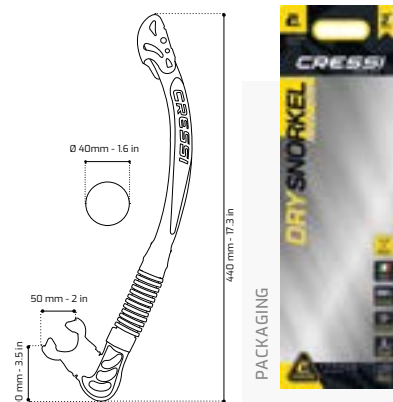



# SUPERNOVA DRY

DRY TOP | PURGE VALVE



CLEAR/  
YELLOW

CLEAR/  
COBALT

CLEAR/  
WHITE

CLEAR/  
PINK



CLEAR/  
BLACK

CLEAR/  
BLUE

CLEAR/  
LILAC



BLACK/  
YELLOW

BLACK/  
BLUE

BLACK/  
BLACK

BLACK/  
RED

CODE	COLOR	CASE PACK
ES259010	CLEAR/YELLOW	50
ES259020	CLEAR/COBALT	50
ES259030	CLEAR/WHITE	50
ES259040	CLEAR/PINK	50
ES259050	CLEAR/BLACK	50
ES259062	CLEAR/BLUE	50
ES259080	CLEAR/LILAC	50
ES259510	BLACK/YELLOW	50
ES259520	BLACK/BLUE	50
ES259550	BLACK/BLACK	50
ES259558	BLACK/RED	50

SPARE PARTS

CODE	PRODUCT
EZ267018	SNORKEL KEEPER for SUPERNOVA DRY/TAO/TAO DRY - BLACK
EZ267018W	SNORKEL KEEPER for SUPERNOVA DRY/TAO/TAO DRY - WHITE
EZ270022	MOUTHPIECE for SUPERNOVA DRY/TAO/TAO DRY - BLACK
EZ270024	MOUTHPIECE for SUPERNOVA DRY/TAO/TAO DRY - CLEAR

TECHNICAL FEATURES

- Dry-top valve seals breathing tube when submerged
- Flexible lower bore reduces jaw fatigue
- Mouthpiece drops away when not in use great for scuba divers
- High quality silicone mouthpiece is comfortable and durable
- Angled mouthpiece reduces jaw fatigue
- Lower purge valve allows water to be quickly expelled
- Streamlined design reduces drag while swimming
- Adjustable snorkel keeper for securing to any mask



DRY GUARD



PURGE VALVE

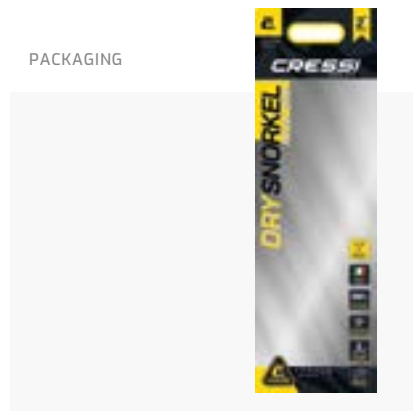

PACKAGING

# TAO DRY

## DRY TOP | PURGE VALVE

It is a dry snorkel that allows divers to take every breath with confidence and focus on the reef below not worrying about water in your airway. The top has a splash guard and a float mechanism that prevents entry of water when submerged. A generous bore contoured tube provides ample airflow and a lower purge valve enables instant clearing when needed. The snorkel keeper allows attaching the snorkel to the mask strap, avoiding losing it on the surface or during diving. The keeper features a quick release system, just push the button to release the snorkel from the mask. Really a great idea and very simple to use.



100% HIGH QUALITY SILICONE

### TECHNICAL FEATURES

- Dry-top valve seals breathing tube when submerged
- Flexible lower bore reduces jaw fatigue
- High-quality silicone mouthpiece is comfortable and durable
- Angled mouthpiece reduces jaw fatigue
- Lower purge valve allows water to be quickly expelled
- Removable adjustable snorkel keeper for securing to any mask

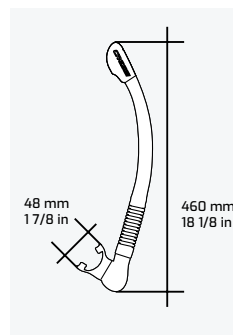

POLYBAG

CODE	COLOR	CASE PACK
ES261002	TAO DRY - CLEAR/BLUE	10

#### SPARE PARTS

CODE	PRODUCT
EZ267018	SNORKEL KEEPER for SUPERNOVA DRY/TAO/TAO DRY - BLACK
EZ267018W	SNORKEL KEEPER for SUPERNOVA DRY/TAO/TAO DRY - WHITE
EZ270022	MOUTHPIECE for SUPERNOVA DRY/TAO/TAO DRY - BLACK
EZ270024	MOUTHPIECE for SUPERNOVA DRY/TAO/TAO DRY - CLEAR

# TAO

## SEMI-DRY TOP | PURGE VALVE



CLEAR/BLACK

BLACK/BLACK



100% HIGH QUALITY SOFT SILICONE BLACK

100% HIGH QUALITY SILICONE

### TECHNICAL FEATURES

- Profiled splash guard significantly reduces water entry
- Flexible lower bore reduces jaw fatigue
- High-quality silicone mouthpiece is comfortable and durable
- Angled mouthpiece reduces jaw fatigue
- Lower purge valve allows water to be quickly expelled
- Removable adjustable snorkel keeper for securing to any mask

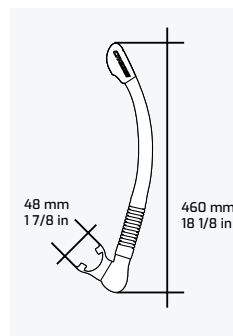

POLYBAG

CODE	COLOR	CASE PACK
ES260050	Clear/Black	10
ES260550	Black/Black	10

# SCILLA DRY NEW 2024



DRY TOP | PURGE VALVE



BLUE/NAVY



ICE CYAN



ROSE GOLD



AQUA GREEN



BLACK



## TECHNICAL FEATURES

- Dry-top valve seals breathing tube when submerged
- Flexible lower bore reduces jaw fatigue
- Mouthpiece drops away when not in use great for scuba divers
- High-quality silicone mouthpiece is comfortable and durable
- Angled mouthpiece reduces jaw fatigue
- Lower purge valve allows water to be quickly expelled
- Streamlined design reduces drag while swimming
- Adjustable snorkel keeper for securing to any mask

CODE	COLOR	CASE PACK
EG350020	Blue Navy	30
EG350028	Ice Cyan	30
EG350061	Rose Gold	30
EG350063	Aqua Green	30
EG355050	Black	30



**YOUR PASSPORT  
TO UNDERWATER  
EXPLORATION!**



# MEXICO

100% HIGH QUALITY SOFT SILICONE BLACK

100% HIGH QUALITY SILICONE

MADE IN ITALY



CLEAR/YELLOW

CLEAR/BLUE

BLACK



A classic snorkel for minimalists, the Mexico includes a splash guard, adjustable snorkel keeper and a soft, silicone mouthpiece. Its efficient design allows for easy clearing and very little drag while swimming.

CODE	COLOR	CASE PACK
EG269010	CLEAR/YELLOW	12
EG269020	CLEAR/BLUE	12
EG269550	BLACK/BLACK	12

SPARE PARTS

CODE	PRODUCT
EZ267005	SNORKEL KEEPER - BLACK FOR CORSICA/MEXICO/GAMMA
EZ267009	SNORKEL KEEPER - CLEAR FOR CORSICA/MEXICO/GAMMA
EZ270029	MOUTHPIECE - BLACK FOR MEXICO/CORSICA
EZ270031	MOUTHPIECE - CLEAR FOR MEXICO/CORSICA

## TECHNICAL FEATURES

- Splash guard
- Hypoallergenic soft silicone

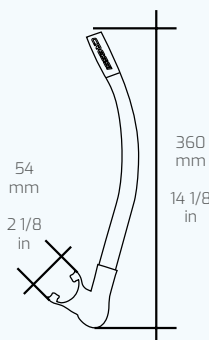

# ISLAND 2.0



CLEAR/CLEAR/BLACK

TRANS. AQUA/CLEAR/BLACK

TRANS. PINK/CLEAR/BLACK

BLACK/BLACK/YELLOW



The Island snorkel features a minimal tube and a mouthpiece bends that provides easier clearing capability. The multi-positional silicone soft mouthpiece provides extreme comfort during prolonged use. The large diameter snorkel tube provides unobstructed ease of breathing. The fixed keeper prevents loss during snorkeling.

CODE	COLOR	CASE PACK
US260050	CLEAR/CLEAR/BLACK	10
US262605	TRANSLUCENT AQUA/CLEAR/BLACK	10
US264205	TRANSLUCENT PINK/CLEAR/BLACK	10
US265510	BLACK/BLACK/YELLOW	10

SPARE PARTS

CODE	PRODUCT
US2631000	MOUTHPIECE - CLEAR FOR ISLAND SNORKEL
US2631050	MOUTHPIECE - BLACK FOR ISLAND SNORKEL

## TECHNICAL FEATURES

- Large diameter snorkel tube provides unobstructed airflow
- Ease of breathing
- Fixed snorkeling keeper
- Hypoallergenic soft silicone mouthpiece

**CRESSI**  
dive center

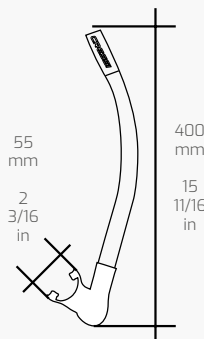





**FINS**  
SNORKELING & BEACH



IDEAL FOR RENTAL

MADE IN ITALY

# PALAU LAF

LONG ADJUSTABLE FINS



BLUE/AZURE



BLACK/YELLOW

BLACK/PINK

These open-heel fins are made for use with bare feet and provide outstanding comfort and versatility. The open-heel design means each fin can accommodate a wider range of sizes, so family members or friends can share the equipment. This allows dive schools or rental departments to stock fewer sizes while providing very high-quality fins to customers. The Palau's blade delivers excellent thrust with a modest kicking effort.

## TECHNICAL FEATURES

- Open heel foot pocket designed for bare feet
- Soft elastomer material delivers outstanding comfort
- Ideal for sharing among family and friends or for rental departments
- Easy-kicking blade responds well to any kicking style
- Blade extends from the top of the foot pocket for maximum surface area



CODE	COLOR	SIZE	CASE PACK
CA112035	Blue/Azure	XS/S	3
CA112038	Blue/Azure	S/M	3
CA112041	Blue/Azure	M/L	3
CA112044	Blue/Azure	L/XL	3
CA115135	Black/Yellow	XS/S	3
CA115138	Black/Yellow	S/M	3
CA115141	Black/Yellow	M/L	3
CA115144	Black/Yellow	L/XL	3
CA115435	Black/Pink	XS/S	3
CA115438	Black/Pink	S/M	3
CA115441	Black/Pink	M/L	3

### SPARE PARTS

CODE	PRODUCT
BZ170003	Fin Strap for Palau Fins
BZ170004	Buckles for Palau Fins

SIZE CONVERSION CHART				
FIN SIZE	EU FOOT SIZE	UK FOOT SIZE	US MEN FOOT SIZE	US WOMEN FOOT SIZE
XS/S	35/38	2/4	4/6.5	5/7.5
S/M	38/41	4/7	6.5/8	7.5/9.5
M/L	41/44	7/10	9.5/11	9.5/12
XL	44/47	10/13	11/13	12/14

PRODUCT DIMENSION CHART			
A	B	C	D
515 mm 20.3 in	195 mm 7.7 in	248 mm 9.8 in	99 mm 3.8 in
535 mm 21.1 in	200 mm 7.9 in	258 mm 10.2 in	100 mm 3.9 in
550 mm 21.7 in	205 mm 8.1 in	265 mm 10.5 in	103 mm 4 in
560 mm 22.1 in	210 mm 8.3 in	269 mm 10.6 in	105 mm 4.1 in

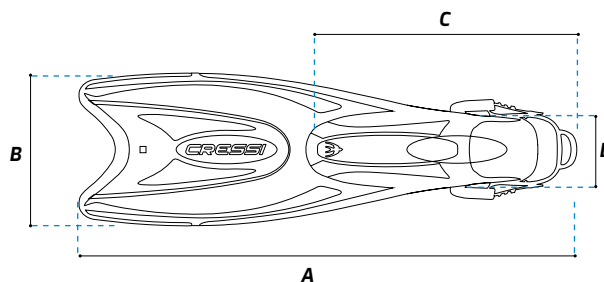

### FITSIZE



TO MAXIMIZE PERFORMANCE AND COMFORT, WEAR FINN WITH:

<input checked="" type="checkbox"/> BARE FOOT	<input checked="" type="checkbox"/> NEOPRENE SOCKS	<input type="checkbox"/> NEOPRENE BOOTS 3 mm - 5 mm - 7 mm	<input type="checkbox"/> HARD SOLE BOOTS 3 mm - 5 mm - 7 mm
---	--	---	--



# PALAU SAF

## SHORT ADJUSTABLE FINS



The Palau short adjustable fin (SAF) opens the way for a new type of snorkeling and swimming fin. It has been designed for two specific purposes. The first was to have a foot pocket that could easily adapt to at least three or four consecutive foot sizes. This would enable the same fin to be used by all the members of a family, or by a group of

friends. It would also make it great for rentals in a diving center or on a charter boat, without requiring an infinite number of sizes. The second purpose was to guarantee extreme comfort and an ease of fit in a strapped open heel fin even if it is to be worn barefoot.

CODE	SIZE	COLOR	CASE PACK
CA132035	XS/S	Blue/Azure	6
CA132038	S/M	Blue/Azure	6
CA132041	M/L	Blue/Azure	6
CA132044	L/XL	Blue/Azure	6
CA135135	XS/S	Black/Yellow	6
CA135138	S/M	Black/Yellow	6
CA135141	M/L	Black/Yellow	6
CA135144	L/XL	Black/Yellow	6
CA135435	XS/S	Black/Pink	6
CA135438	S/M	Black/Pink	6
CA135441	M/L	Black/Pink	6

### SPARE PARTS

CODE	PRODUCT
BZ170003	Fin Strap for Palau Fins
BZ170004	Buckles for Palau Fins

### TECHNICAL FEATURES

- Short blade and open heel foot pocket
- Designed for bare feet
- Soft elastomer material delivers outstanding comfort
- Ideal for sharing among family and friends or for rental departments
- Easy-kicking blade responds well to any kicking style



SIZE CONVERSION CHART				
FIN SIZE	EU FOOT SIZE	UK FOOT SIZE	US MEN FOOT SIZE	US WOMEN FOOT SIZE
XS/S	35/38	2/4	4/6.5	5/7.5
S/M	38/41	4/7	6.5/8	7.5/9.5
M/L	41/44	7/10	9.5/11	9.5/12
L/XL	44/47	10/13	11/13	12/14

PRODUCT DIMENSION CHART			
A	B	C	D
402 MM 15.9 IN	191 MM 7.5 IN	248 MM 9.8 IN	97 MM 3.8 IN
415 MM 16.4 IN	197 MM 7.7 IN	248 MM 9.8 IN	97 MM 3.8 IN
427 MM 16.8 IN	202 MM 7.9 IN	258 MM 10.2 IN	100 MM 3.9 IN
435 MM 17.2 IN	206 MM 8.1 IN	265 MM 10.4 IN	103 MM 4.1 IN

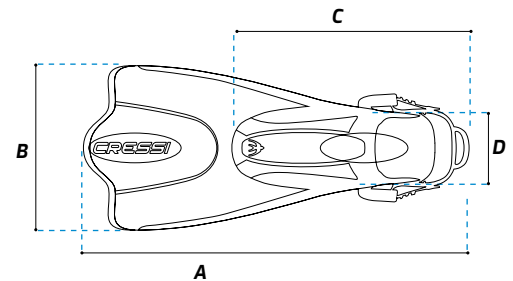

⚠️ FINS COULD COME LABELED WITH EU AND UK SIZES ONLY  
 CRESSI'S SIZE CHART TO BE USED AS A REFERENCE ONLY  
 USA REV. 06/2023

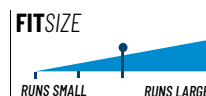

TO MAXIMIZE PERFORMANCE AND COMFORT, WEAR FIN WITH:

<input checked="" type="checkbox"/>	<input checked="" type="checkbox"/>	<input type="checkbox"/>	<input type="checkbox"/>
BARE FOOT	NEOPRENE SOCKS	NEOPRENE BOOTS 2 mm - 3 mm + 1 mm	HARD SOLE BOOTS 2 mm - 3 mm + 1 mm



# TONGA

## SHORT ADJUSTABLE FINS



BLACK/BLUE



BLACK/PINK



BLACK/BLACK

The Cressi Tonga are short open heel fins with adjustable straps to use both outdoors and indoors. They are ideal for travelers thanks to their dimensions and light weight.

The buckles have a special design to ensure robustness and long use. The fin strap features a large thumb loop to make easy the donning and doffing. It is also practical to hang them on a hook.

The foot pocket is made of a rubber material that makes donning comfortable and easily adapts to different shapes of feet. Being an open foot pocket fin with an adjustable strap, it adapts to different shapes of feet and can also be shared between different people who have a similar size. The composite design of the blade provides comfortable finning and helps to reduce leg cramping. The fins come with a practical net bag ideal for rinsing the fins after use and removing any sand.

### TECHNICAL FEATURES

- Adult short adjustable snorkeling fins
- Adaptive and comfortable foot pocket made in rubber
- Adjustable strap length
- Buckle specially designed to ensure robustness and long use
- Short blade, ideal for travel



2024 - CATALOG

CODE	COLOR	SIZE	CASE PACK
CA285201	Black/Blue	S/M	10
CA285202	Black/Blue	L/XL	10
CA285401	Black/Pink	S/M	10
CA285402	Black/Pink	L/XL	10
CA285551	Black/Black	S/M	10
CA285552	Black/Black	L/XL	10

### SPARE PARTS

CODE	PRODUCT
US2100020	Strap & Buckles Assembly - Black/Blue for Bonete/Tonga
US2100041	Strap & Buckles Assembly - Black/Pink for Bonete/Tonga
US2100050	Strap & Buckles Assembly - Black/Black for Bonete/Tonga



PRODUCT DIMENSION CHART						SIZE		US SHOE SIZE	
FIN SIZE	A LENGTH	B WIDTH	C LENGTH FIT	D WIDTH FIT	FIN HEIGHT FIT	FIN SIZE	UK FOOT SIZE	US MEN'S FOOT SIZE	US WOMEN'S FOOT SIZE
S / M	454 mm / 17.9 in	182 mm / 7.2 in	245 mm / 10.0 in	105 mm / 4.1 in	74 mm / 2.9 in	36/41	3 / 7	4.5 / 8.5	5 / 9.5
L / XL	468 mm / 18.4 in	182 mm / 7.2 in	259 mm / 10.2 in	105 mm / 4.1 in	74 mm / 2.9 in	42/47	7.5 / 11.5	9 / 13	10 / 14

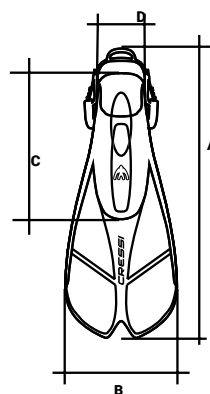

Cressi's Size Chart is to be used as a reference only

CRESSI



# BONETE PRO

## SHORT ADJUSTABLE FINS



TRANSLUCENT AQUA



TRANSLUCENT PINK

The Bonete fins are short, open-heel fins with adjustable straps. The redesigned buckle system increases the sturdiness and ensures a long lifespan. The fin strap features a large thumb loop for easy donning and doffing. They can also be hung on a hook for drying. The foot pocket is made of a rubber material for comfort and adapts to all feet. This open-foot pocket fin comes with an adjustable strap, which allows it to be shared between different people in a similar foot size-range. The composite design of the blade provides comfortable finning and helps reduce leg cramping. A practical net bag is included with the fins, ideal for rinsing them after use and removing any sand. The fins are ideal for travelers due to their compact dimensions and light weight.

### TECHNICAL FEATURES

- Open heel short blade
- Above blade foot pocket
- Adjustable strap length

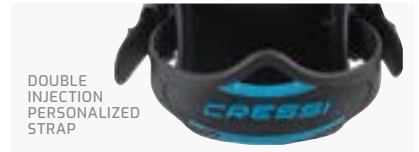

DOUBLE INJECTION PERSONALIZED STRAP



FIN DETAILS



NEWLY REDESIGNED BUCKLE SYSTEM. INCREASED STURDINESS AND LIFESPAN



CODE	COLOR	SIZE	CASE PACK
CA240261	Translucent Aqua	S/M	10
CA240262	Translucent Aqua	L/XL	10
CA240401	Translucent Pink	S/M	10
CA240402	Translucent Pink	L/XL	10

### SPARE PARTS

CODE	PRODUCT
US2100020	STRAP & BUCKLES ASSEMBLY - BLACK/BLUE FOR BONETE/TONGA
US2100041	STRAP & BUCKLES ASSEMBLY - BLACK/PINK FOR BONETE/TONGA
US2100050	STRAP & BUCKLES ASSEMBLY - BLACK/BLACK FOR BONETE/TONGA



FIN SIZE	PRODUCT DIMENSION CHART					EU SHOE SIZE		US SHOE SIZE	
	A LENGTH	B WIDTH	C LENGTH FIT	D WIDTH FIT	FIN HEIGHT FIT	EU	US MEN'S FOOT SIZE	US WOMEN'S FOOT SIZE	
S/M	396 mm 15.6 in	180 mm 7.1 in	265 mm 10.4 in	103 mm 4.1 in	75 mm 3.0 in	36 / 41	4.5 / 8.5	5.5 / 9.5	
L/XL	411 mm 16.2 in	180 mm 7.1 in	269 mm 10.6 in	105 mm 4.1 in	76 mm 3.0 in	42 / 47	9 / 13	10 / 14	

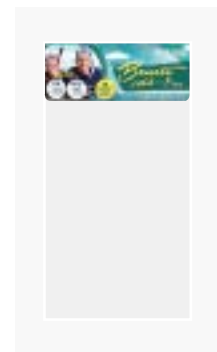
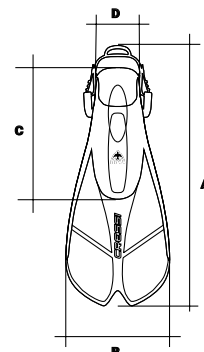

Cressi's Size Chart is to be used as a reference only

# PLUMA

## FULL FOOT POCKET FINS



BLUE/AZURE



BLACK/SILVER

This high-tech fin designed specifically for snorkeling benefits from the best technologies used in freediving and scuba diving. Cressi's unique molding process also allows for the use of three separate materials to create a highly-responsive blade. Now, snorkelers can power through currents and enjoy hours on the water without undue muscle strain. The Pluma's computer-designed foot pocket provides excellent power transmission and unparalleled comfort.

### TECHNICAL FEATURES

- Patented Cressi molding technology used to create lightweight, responsive blade
- Computer designed foot pocket with stiff base better transmits power down the blade
- Soft thermo-rubber foot pocket material is comfortable for extended wear
- Lightweight polypropylene blade
- Blade ribs provide precise flex control for maximum thrust



FINS WEARABILITY:



CODE	SIZE	COLOR	CASE PACK
CA172035	35/36	BLUE/AZURE	6
CA172037	37/38	BLUE/AZURE	6
CA172039	39/40	BLUE/AZURE	6
CA172041	41/42	BLUE/AZURE	6
CA172043	43/44	BLUE/AZURE	6
CA172045	45/46	BLUE/AZURE	6
CA175035	35/36	BLACK/SILVER	6
CA175037	37/38	BLACK/SILVER	6
CA175039	39/40	BLACK/SILVER	6
CA175041	41/42	BLACK/SILVER	6
CA175043	43/44	BLACK/SILVER	6
CA175045	45/46	BLACK/SILVER	6

PRODUCT DIMENSION CHART						SIZE		US SHOE SIZE	
FIN SIZE	A LENGTH	B WIDTH	C LENGTH FIT	D WIDTH FIT	FIN HEIGHT FIT	FIN SIZE	UK FOOT SIZE	US MEN'S FOOT SIZE	US WOMEN'S FOOT SIZE
35/36	537 mm / 21.2 in	178 mm / 7 in	240 mm / 9.5 in	89 mm / 3.5 in	64 mm / 2.5 in	35/36	2.5 / 3.5	3.5 / 4.5	4.5 / 5.5
37/38	555 mm / 21.9 in	185 mm / 7.3 in	250 mm / 9.9 in	91 mm / 3.6 in	68 mm / 2.7 in	37/38	4 / 5	5 / 6	6 / 7
39/40	578 mm / 22.8 in	190 mm / 7.5 in	258 mm / 10.2 in	95 mm / 3.8 in	72 mm / 2.8 in	39/40	5.5 / 6.5	6.5 / 7.5	7.5 / 8.5
41/42	595 mm / 23.4 in	197 mm / 7.8 in	266 mm / 10.5 in	99 mm / 3.9 in	72 mm / 3 in	41/42	7 / 8	8 / 9	9 / 10
43/44	610 mm / 24.0 in	203 mm / 8 in	275 mm / 10.9 in	103 mm / 4.1 in	72 mm / 2.8 in	43/44	8.5 / 9.5	9.5 / 10.5	10.5 / 11.5
45/46	629 mm / 24.8 in	210 mm / 8.3 in	285 mm / 11.2 in	105 mm / 4.12 in	78 mm / 3.1 in	45/46	10 / 11	11 / 12	12 / 13

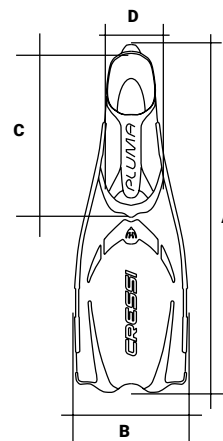

Cressi's Size Chart is to be used as a reference only

# AGUA

## FULL FOOT SNORKELING FINS



YELLOW BLUE PINK

Agua is a very easy fin to use, and doesn't require any special athletic or water-sport abilities, yet it still delivers excellent performance without tiring your feet. Thanks to the latest technology and Cressi's experience in developing these products, we've been able to markedly decrease the weight of this fin compared to others in its category, while still preserving excellent responsiveness. The foot pocket features the original Self Adjusting Foot Pocket system, which thanks to the special softness and elasticity of the blends makes for a consistently soft and adherent fit.

### TECHNICAL FEATURES

- Full foot long blade
- Above blade
- Foot pocket light weight



CODE	SIZE	COLOR	CASE PACK
CA201035	35/36	YELLOW	6
CA201037	37/38	YELLOW	6
CA201039	39/40	YELLOW	6
CA201041	41/42	YELLOW	6
CA201043	43/44	YELLOW	6
CA201045	45/46	YELLOW	6
CA206235	35/36	BLUE	6
CA206237	37/38	BLUE	6
CA206239	39/40	BLUE	6
CA206241	41/42	BLUE	6
CA206243	43/44	BLUE	6
CA206245	45/46	BLUE	6
CA206435	35/36	PINK	6
CA206437	37/38	PINK	6
CA206439	39/40	PINK	6



PRODUCT DIMENSION CHART						SIZE		US SHOE SIZE	
FIN SIZE	A LENGTH	B WIDTH	C LENGTH FIT	D WIDTH FIT	FIN HEIGHT FIT	FIN SIZE	UK FOOT SIZE	US MEN'S FOOT SIZE	US WOMEN'S FOOT SIZE
35/36	485 mm/19.1 in	171 mm/6.8 in	221 mm/8.7 in	86 mm/3.4 in	66 mm/2.6 in	35/36	2.5 / 3.5	3.5 / 4.5	4.5 / 5.5
37/38	504 mm/19.9 in	176 mm/6.9 in	235 mm/9.3 in	89 mm/3.5 in	68 mm/2.7 in	37/38	4 / 5	5 / 6	6 / 7
39/40	524 mm/20.7 in	182 mm/7.1 in	247 mm/9.7 in	92 mm/3.6 in	68 mm/2.7 in	39/40	5.5 / 6.5	6.5 / 7.5	7.5 / 8.5
41/42	545 mm/21.5 in	187 mm/7.4 in	261 mm/10.3 in	95 mm/3.7 in	70 mm/2.8 in	41/42	7 / 8	8 / 9	9 / 10
43/44	565 mm/22.3 in	192 mm/7.6 in	275 mm/10.9 in	97 mm/3.8 in	74 mm/2.9 in	43/44	8.5 / 9.5	10 / 11	11 / 12
45/46	587 mm/23.1 in	198 mm/7.8 in	288 mm/11.4 in	100 mm/3.9 in	77 mm/3 in	45/46	10 / 11	11.5 / 12.5	12.5 / 13.5

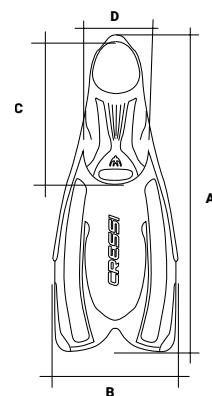

Cressi's Size Chart is to be used as a reference only

# RONDINELLA

## FULL FOOT POCKET FINS



### TECHNICAL FEATURES

- Full foot long blade
- Above blade foot pocket
- Reactive polypropylene blade
- Flexible and comfortable foot pocket
- Light and powerful



The Rondinella is the ideal fin for snorkeling and swimming. Made with the same materials as the more technical range: polypropylene for the skin and very flexible thermoplastic rubber for footwear and side members. Polypropylene is the main elastic of the blade which translates into a fluid and effective finning with reduced effort.

The fin is designed with the shoe in the middle of the blade so that the transmission of force is effective, with a progressive and pleasant movement for the swimmer, reducing the hydrodynamic resistance of the upper part of the foot.

The sole of the shoe has a calculated rigidity to avoid foot cramps. The back area of the foot pocket is larger and reinforced, and a small rubber tab on the upper part makes it easier to put it on.

Its proportioned design, the materials, and the comfort of its structure are an excellent quality / price / comfort ratio of the fins of this category.



CODE	SIZE	COLOR	CASE PACK
CA182035	35/36	BLUE	6
CA182037	37/38	BLUE	6
CA182039	39/40	BLUE	6
CA182041	41/42	BLUE	6
CA182043	43/44	BLUE	6
CA182045	45/46	BLUE	6
CA182047	47/48	BLUE	6

PRODUCT DIMENSION CHART						SIZE		US SHOE SIZE	
FIN SIZE	A LENGTH	B WIDTH	C LENGTH FIT	D WIDTH FIT	FIN HEIGHT FIT	FIN SIZE	UK FOOT SIZE	US MEN'S FOOT SIZE	US WOMEN'S FOOT SIZE
35/36	512 mm/20.2 in	182 mm/7.2 in	220 mm/8.7 in	82 mm/3.2 in	64 mm/2.5 in	35/36	2.5 / 3.5	3.5 / 4.5	4.5 / 5.5
37/38	532 mm/21 in	187 mm/ 7.4 in	232 mm/9.2 in	85 mm/3.3 in	68 mm/2.7 in	37/38	4 / 5	5 / 6	6 / 7
39/40	551 mm/21.7 in	193 mm/7.6 in	246 mm/9.7 in	87 mm/3.4 in	68 mm/2.7 in	39/40	5.5 / 6.5	6.5 / 7.5	7.5 / 8.5
41/42	573 mm/22.6 in	198 mm/ 7.8 in	256 mm/10.1 in	89 mm/3.5 in	73 mm/2.8 in	41/42	7 / 8	8 / 9	9 / 10
43/44	590 mm/23.3 in	203 mm/8 in	268 mm/10.6 in	92 mm/3.6 in	73 mm/2.8 in	43/44	8.5 / 9.5	10 / 11	11 / 12
45/46	613 mm/24.2 in	209 mm/8.2 in	280 mm/11.1 in	95 mm/3.7 in	75 mm/2.9 in	45/46	10 / 11	11.5 / 12.5	12.5 / 13.5
47/48	638 mm/25.2 in	212 mm/8.4 in	290 mm/11.5 in	98 mm/3.8 in	78 mm/3.1 in	47/48	12 / 13	13 / 14	14 / 15

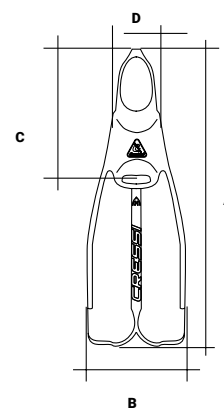



# CLIQ

## FULL FOOT POCKET FINS



YELLOW

BLUE

BLACK

Colorful and functional, the Cliq has been a staple of the Cressi fins line for many years. The blade, made with EVA, is melted during the molding with a Soft Thermo-Rubber (elastomer) used for the foot pocket, for the side stringers and for some inserts, to offer maximum quality and comfort. It features a fluid and undemanding kick, perfect for children and adults alike. Because of its extreme comfort, prolonged use of the fin is possible. The Cliq is an excellent fin for snorkeling and swimming.

### TECHNICAL FEATURES

- Blade made of EVA
- Computer-designed foot pocket
- Foot pocket above blade



CODE	SIZE	COLOR	CASE PACK
CA101035	35/36	YELLOW	6
CA101037	37/38	YELLOW	6
CA101039	39/40	YELLOW	6
CA101041	41/42	YELLOW	6
CA101043	43/44	YELLOW	6
CA101045	45/46	YELLOW	6
CA102035	35/36	BLUE	6
CA102037	37/38	BLUE	6
CA102039	39/40	BLUE	6
CA102041	41/42	BLUE	6
CA102043	43/44	BLUE	6
CA102045	45/46	BLUE	6
CA102047	47/48	BLUE	6
CA105035	35/36	BLACK	6
CA105037	37/38	BLACK	6
CA105039	39/40	BLACK	6
CA105041	41/42	BLACK	6

PRODUCT DIMENSION CHART						SIZE		US SHOE SIZE	
FIN SIZE	A LENGTH	B WIDTH	C LENGTH FIT	D WIDTH FIT	FIN HEIGHT FIT	FIN SIZE	UK FOOT SIZE	US MEN'S FOOT SIZE	US WOMEN'S FOOT SIZE
35/36	485 mm/19.1 in	171 mm/6.8 in	221 mm/8.7 in	86 mm/3.4 in	66 mm/2.6 in	35/36	2.5 / 3.5	3.5 / 4.5	4.5 / 5.5
37/38	504 mm/19.9 in	176 mm/6.9 in	235 mm/9.3 in	89 mm/3.5 in	68 mm/2.7 in	37/38	4 / 5	5 / 6	6 / 7
39/40	524 mm/20.7 in	182 mm/7.1 in	247 mm/9.7 in	92 mm/3.6 in	68 mm/2.7 in	39/40	5.5 / 6.5	6.5 / 7.5	7.5 / 8.5
41/42	545 mm/21.5 in	187 mm/7.4 in	261 mm/10.3 in	95 mm/3.7 in	70 mm/2.8 in	41/42	7 / 8	8 / 9	9 / 10
43/44	565 mm/22.3 in	192 mm/7.6 in	275 mm/10.9 in	97 mm/3.8 in	74 mm/2.9 in	43/44	8.5 / 9.5	10 / 11	11 / 12
45/46	587 mm/23.1 in	198 mm/7.8 in	288 mm/11.4 in	100 mm/3.9 in	77 mm/3 in	45/46	10 / 11	11.5 / 12.5	12.5 / 13.5
47/48	595 mm/23.5 in	200 mm/7.9 in	294 mm/11.6 in	96 mm/3.7 in	78 mm/3.1 in	47/48	11.5 / 13	13 / 14	14 / 15

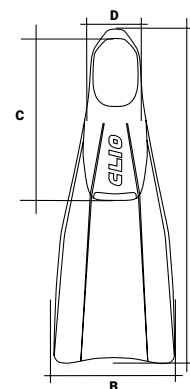

Cressi's Size Chart is to be used as a reference only

# AGUA SHORT

2024 - CATALOG



## TECHNICAL FEATURES

- Light polypropylene blade
- Self-adjusting foot pocket system
- Above blade foot pocket
- Short blade



MAXIMUM FLEXIBILITY

The Agua Short swim fin is the shorter more versatile version of Cressi's popular Agua long blade fin. The Agua Short fin is ideal for travelers and it is a concrete swimming aid either for pool or sea swimmers or snorkelers. It has the same features as Cressi fins such as an above-the-blade, self-adjusting

foot pocket for incredible flexibility and comfort. The Agua Short fin is great for any level of user and it is a must-have for your next tropical vacation or water workout next time you travel.

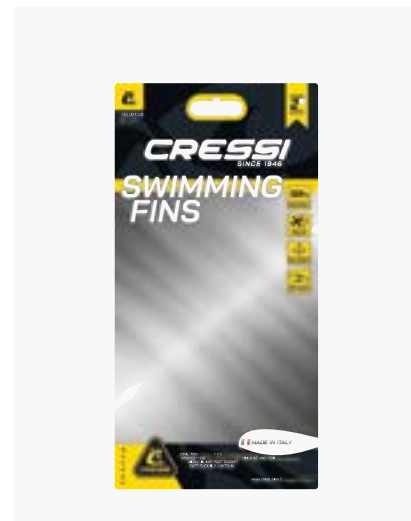

CODE	SIZE	COLOR	CASE PACK
DP206235	35/36	Blue	3
DP206237	37/38	Blue	3
DP206239	39/40	Blue	3
DP206241	41/42	Blue	3
DP206243	43/44	Blue	3
DP206245	45/46	Blue	3
DP206247	47/48	Blue	3

PRODUCT DIMENSION CHART						SIZE		US SHOE SIZE	
FIN SIZE	A LENGTH	B WIDTH	C LENGTH FIT	D WIDTH FIT	FIN HEIGHT FIT	FIN SIZE	UK FOOT SIZE	US MEN'S FOOT SIZE	US WOMEN'S FOOT SIZE
35/36	334 mm/13.2 in	161 mm/6.4 in	227 mm/9 in	74 mm/2.9 in	68 mm/2.7 in	35 / 36	2.5 / 3.5	3.5 / 4.5	4.5 / 5.5
37/38	358 mm/14.1 in	169 mm/6.7 in	241 mm/9.5 in	75 mm/3 in	70 mm/2.8 in	37 / 38	4 / 5	5 / 6	6 / 7
39/40	372 mm/14.7 in	174 mm/6.9 in	257 mm/10 in	81 mm/3.2 in	72 mm/2.9 in	39 / 40	5.5 / 6.5	6.5 / 7.5	7.5 / 8.5
41/42	390 mm/15.4 in	180 mm/7.1 in	264 mm/10.4 in	85 mm/3.4 in	75 mm/3 in	41 / 42	7 / 8	8 / 9	9 / 10
43/44	405 mm/16 in	187 mm/7.4 in	273 mm/10.8 in	90 mm/3.6 in	75 mm/3 in	43 / 44	8.5 / 9.5	9.5 / 10.5	10.5 / 11.5
45/46	423 mm/16.7 in	193 mm/7.6 in	285 mm/11.3 in	93 mm/3.7 in	78 mm/3.1 in	45 / 46	10 / 11	11 / 12	12 / 13
47/48	439 mm/17.3 in	199 mm/7.9 in	296 mm/11.7 in	97 mm/3.8 in	79 mm/3.2 in	47 / 48	12 / 13	13 / 14	14 / 15

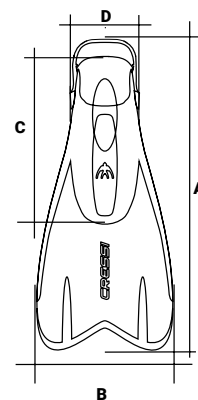

CRESSI

# LIGHT

SPECIFICALLY DESIGNED FOR TRAINING AND BUILDING MUSCLES



## TECHNICAL FEATURES

- Increased speed
- Improved leg strength and flexibility
- Improved body motion & position
- Improved racing technique
- Anatomic foot pocket
- Short blade



The Light fins are specifically designed for pool use and for swim training, but can also be used adequately for recreational swimming and snorkeling. The short blade is made of a highly reactive and light material which guarantees agile and effective kicking without tiring out your legs. The length of the blade has been researched and studied by Cressi to ensure

perfect muscle training without causing cramps or discomfort. The anatomically designed foot pocket is made from soft rubber elastomers, and it houses the foot with a great deal of comfort, even during long swimming sessions.

CODE	SIZE	COLOR	CASE PACK
DP182033	33/34	Blue	3
DP182035	35/36	Blue	3
DP182037	37/38	Blue	3
DP182039	39/40	Blue	3
DP182041	41/42	Blue	3
DP182043	43/44	Blue	3
DP182045	45/46	Blue	3

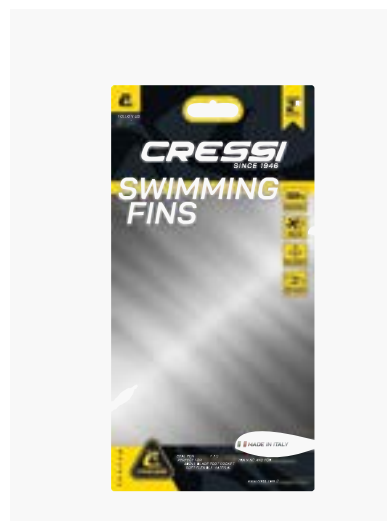

PRODUCT DIMENSION CHART						SIZE		US SHOE SIZE	
FIN SIZE	A LENGTH	B WIDTH	C LENGTH FIT	D WIDTH FIT	FIN HEIGHT FIT	FIN SIZE	UK FOOT SIZE	US MEN'S FOOT SIZE	US WOMEN'S FOOT SIZE
33/34	291 mm/11.5 in	161 mm/6.3 in	192 mm/7.6 in	82 mm/3.2 in	65 mm/2.5 in	33/34	1 / 2	1.5 / 2.5	2.5 / 3.5
35/36	310 mm/12.2 in	165 mm/6.5 in	220 mm/8.6 in	82 mm/3.2 in	65 mm/2.5 in	35/36	2.5 / 3.5	2.5 / 3.5	4.5 / 5.5
37/38	335 mm/13.2 in	170 mm/6.7 in	232 mm/9.2 in	85 mm/3.3 in	70 mm/2.7 in	37/38	4 / 5	5 / 6	6 / 7
39/40	347 mm/13.7 in	175 mm/6.9 in	246 mm/9.6 in	87 mm/3.4 in	70 mm/2.7 in	39/40	5.5 / 6.5	6.5 / 7.5	7.5 / 8.5
41/42	372 mm/14.7 in	185 mm/7.3 in	256 mm/10.1 in	89 mm/3.5 in	71 mm/2.8 in	41/42	7 / 8	8 / 9	9 / 10
43/44	385 mm/15.2 in	190 mm/7.5 in	268 mm/10.6 in	92 mm/3.6 in	71 mm/2.8 in	43/44	8.5 / 9.5	9.5 / 10.5	10.5 / 11.5
45/46	410 mm/16.2 in	195 mm/7.7 in	280 mm/11 in	95 mm/3.7 in	73 mm/2.9 in	45/46	10 / 11	11 / 12	12 / 13

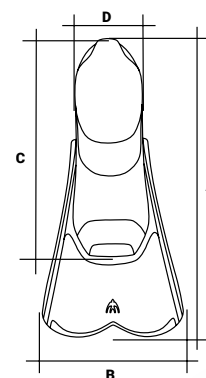

# PURA NEW 2024

## SILICONE SNORKELING & SWIMMING FINS



### TECHNICAL FEATURES

- Versatility and comfort
- Intensive training
- 100% silicone

**FINS WEARABILITY:**



BARE FOOT

Pura swimming fins are made of highly versatile and comfortable silicone. These fins are designed for swimmers who wish to intensively train their legs and ankles, increasing strength in the abdominal and lumbar area. Made of 100% silicone, the Pura fins are easy to wear. This model of short fins best completes the Cressi line dedicated to swimming. All in all, these fins are great for family snorkel trips and will allow hours of underwater exploration.

CODE	SIZE	COLOR
XCA602035	33/34	Blue/Azure
XCA602038	35/36	Blue/Azure
XCA602040	37/38	Blue/Azure
XCA602043	39/40	Blue/Azure
XCA602045	41/42	Blue/Azure

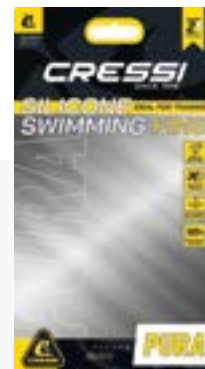



# SNORKEL VEST

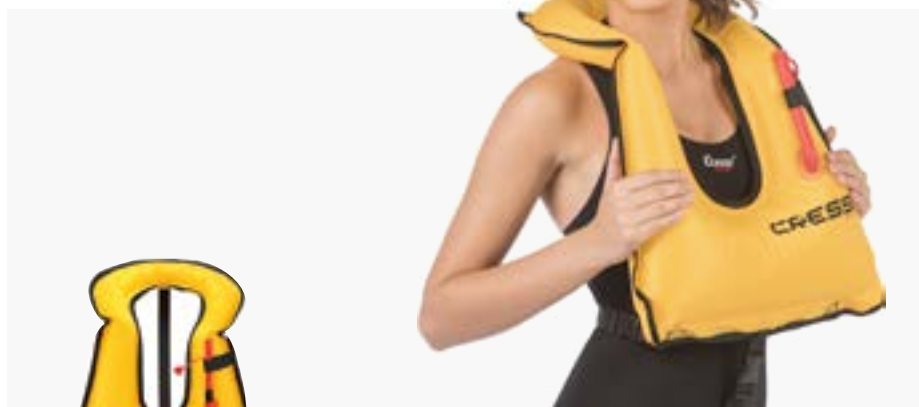

YELLOW

## TECHNICAL FEATURES

- Fully adjustable waist and crotch straps
- Durable 220 denier material with EVA coating
- Oral inflation tube provides simple, reliable operation

CODE	COLOR	SIZE
SV100085	Yellow	M/L
SV100086	Yellow	XL

# SWIM BUOY



## TECHNICAL FEATURES

- Hydrodynamic shape
- Red fluorine fabric for great visibility.
- Brilliant finish for an ideal slide.
- Internal compartment with water tightness system specially effective with rigid soul.
- Mouth inflator with safety closing screwing.
- Dimension when inflated:  
52 x 34 x 20 cm | 20.5 x 13.5 x 8 in.
- Weight: 538 g | 1 lb 3 oz
- Strap length: 60 cm | 23.6 in.
- Waist belt length: 124 cm | 48.8 in.

CODE	COLOR
TA611981	Red



ACCESSORIES  
SNORKELING & BEACH



# ANTI-FOG

## SPRAY

// 60 ML

Effective anti-fog for masks and goggles. Spread on the inside of the lenses, before wetting them.

0% ALCOHOL



CODE

DF200050

## GEL

// 30 ML



CODE

DF200052

## MINIFOG SPONGE

// 15 ML



CODE

DF200053

# DRY BOX



CODE

TA700003

# LINE CUTTER



Simple, efficient line cutting tool with safety-blade design. The sheath can be mounted on harness rig or on a B.C.D.

- STAINLESS STEEL SERRATED BLADE
- QUICK-RELEASE SHEATH



CODE

RC555500

# ALLIGATOR

420 JAPANESE  
420 STEEL

2 IN 1: KNIFE/SCISSORS



Knife-scissors very practical for all types of operations underwater. Made of high-strength stainless steel, it is helpful as scissors, as a knife with a smooth edge blade, or as a saw blade, and also has a valuable recess as a wire cutter. Includes serration for use as pliers. Compared to other similar knives, it has the advantage of its contained size and its full use and ergonomics without having to open it to cut efficiently using it as a knife. Excellent cutting capacity and oxidation resistance.

## TECHNICAL FEATURES

- Blade length: 8.6 cm - 3.38 inch
- Total length: 17.5 cm - 6.88 inch
- Blade width: 26 mm - 1.02 inch
- Blade thicknesses: 6 mm - 0.23 inch
- Knife-only weight: 125 gr - 0.27 lb
- Weight with sheath: 164 gr - 0.36 lb

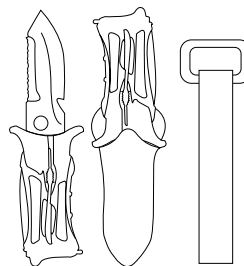

CODE

RC559200



PACKAGING

# MASK STRAP COVER

NEOPRENE



CODE	COLOR	CASE PACK
D5339992	Blue	20
D5339994	Pink	20
D5339995	Black	20
D5339997	Red	20
D5339996	Yellow	20

# PONY TAIL MASK STRAP COVER

NEOPRENE



CODE	COLOR
DQ021050	Yellow/Black
DQ022030	Blue/White
DQ024030	Pink/White
DQ025010	Black/Yellow

# SIMPLY MASK STRAP COVER

NEOPRENE



CODE	COLOR
DQ011050	Yellow/Black
DQ012030	Blue/White
DQ015010	Black/Yellow



# NINJA FLOATING



CODE	COLOR	STYLE
DB100002	Black/Black	Dark lenses

## TECHNICAL FEATURES

- Sunglasses for water sports
- Soft rubber coating
- Polarized filter
- 3 category high quality shatterproof lenses with 100% UV protection
- Antireflection



# NEO EYEWEAR RETAINER



CODE	COLOR
DQ031050	Yellow/Black
DQ032730	Blue Navy/White
DQ035010	Black/Yellow



# KIDS

SNORKELING, BEACH & SWIMMING







SCUBA  
DIVER  
KEY

KIDS

# BARON JR & ROCKS SET

BARON JR FULL FACE MASK  
+ ROCKS FINS



BLUE/WHITE

LILAC/WHITE

CODE	COLOR	CASE PACK	SIZE
SE0202032	Blue/White	6	L/XL
SE0204132	Lilac/White	6	L/XL

TECHNICAL FEATURES

- 30% larger viewing area, snorkelers can see all the underwater world has to offer without feeling claustrophobic
- Dry snorkel keeps water out, while a specialized deflector maximizes air circulation and eliminates fogging
- The valve's design gives the user effortless and natural breathing, with a wide breathing area around the nose and mouth
- Water draining valves safely remove any water that may enter the mask
- This mask is designed for surface use only and should not be used at depth
- Face skirt is made of soft hypoallergenic silicone for comfort and an excellent seal
- Two x-cross straps are easy to adjust for a perfect adaption to your head
- Frame and lens are made of polycarbonate material
- Made in two sizes to ensure proper fitting
- Adjustable straps
- Straps have large thumb loop for easy donning and doffing.
- Dual vented blades for power and energy saving.
- Compact size, good for travel.

0	1	2	3	4	5	6	7	8	9	10	11	12	13	14	15	16
YEARS OLD																



AVAILABLE FULL FACE MASK WALL

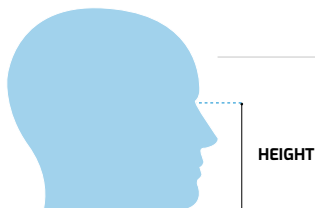

HEIGHT

BARON JR DIMENSION CHART			
SIZE	HEIGHT (MM)	HEIGHT (IN)	KIDS AGE
XS/S	< 100	< 4	6-12 YEARS

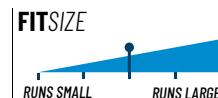
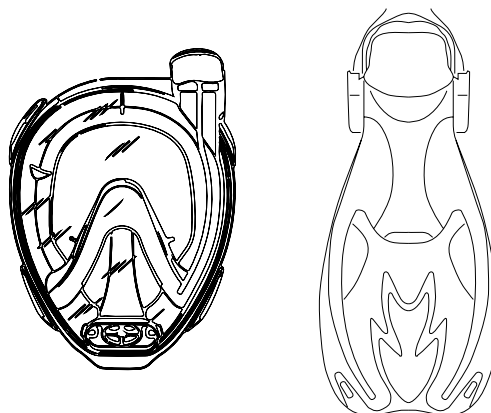

ROCKS SIZE CONVERSION CHART					
FIN SIZE	EU FOOT SIZE	UK FOOT SIZE	US FOOT SIZE	KID AGE	FOOT LENGHT
L/XL	32/38	13K / 5Y	1/6Y	6/10 YEARS	20-24 cm 8 1/8 - 9 1/2 in

TO MAXIMIZE PERFORMANCE AND COMFORT, WEAR FIN WITH:

<input checked="" type="checkbox"/>	<input type="checkbox"/>	<input type="checkbox"/>	<input type="checkbox"/>
BARE FOOT	NEOPRENE SOCKS	NEOPRENE BOOTS 2 mm + 5 mm + 7 mm	HARD SOLE BOOTS 2 mm + 5 mm + 7 mm

CRESSI'S SIZE CHART TO BE USED AS A REFERENCE ONLY

USA REV. 06/2023



**KIDS**

# ROCKS PRO DRY SET

PEGASO MASK + IGUANA DRY SNORKEL + ROCKS FINS



LILAC/WHITE



BLUE/WHITE

The Rocks kids set comes with the Pegaso Mask and Iguana Snorkel combo and also a pair of easy-adjustable snorkel fins.

Two sizes fit all in two colors. We completed this bag set with a nice mesh bag to easily and comfortably carry, rinse, dry and store the set after use. A complete bag set with a low price point for kids adventures that will last all day.

CODE	COLOR	SIZE	CASE PACK
SE262031	Blue/White	S/M	10
SE262032	Blue/White	L/XL	10
SE264131	Lilac/White	S/M	10
SE264132	Lilac/White	L/XL	10

### TECHNICAL FEATURES

- Short adjustable open-heel fins
- Dry snorkel with quick-release keeper and purge valve
- Soft silicone dual-lens mask

0	1	2	3	4	5	6	7	8	9	10	11	12	13	14	15	16
YEARS OLD																



SIZE CONVERSION CHART					
FIN SIZE	EU FOOT SIZE	UK KID'S FOOT SIZE	US KID'S FOOT SIZE	KIDS AGE	FOOT LENGHT
S/M	26/32	8.5/12.5 k	4/6.5	3/5 YEARS	16-20 cm 6 1/3 - 8 1/8 in
L/XL	32/38	13k/5y	6.5/8	6/10 YEARS	20-24 cm 8 1/8 - 9 1/2 in

PRODUCT DIMENSION CHART				
A	B	C	D	FIN HEIGHT FIT
348 mm 13.7 in	170 mm 6.7 in	188 mm 7.4 in	79 mm 3.2 in	58 mm 2.3 in
379 mm 14.9 in	177 mm 7 in	205 mm 8.1 in	87 mm 3.5 in	59 mm 2.4 in

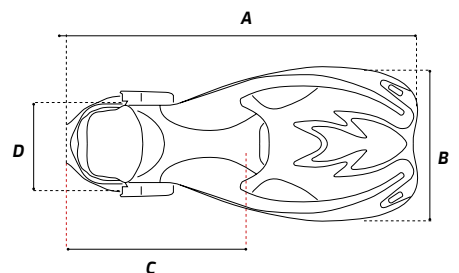

FINS COULD COME LABELED WITH EU AND UK SIZES ONLY CRESSI'S SIZE CHART TO BE USED AS A REFERENCE ONLY

USA REV. 06/2023

### FIT SIZE



TO MAXIMIZE PERFORMANCE AND COMFORT, WEAR FINN WITH:

<input checked="" type="checkbox"/>	<input type="checkbox"/>	<input type="checkbox"/>	<input type="checkbox"/>
BARE FOOT	NEOPRENE SOCKS	NEOPRENE BOOTS 3 mm x 3 mm x 3 mm	HARD SOLE BOOTS 3 mm x 3 mm x 3 mm

A young boy with blonde hair is underwater, wearing a clear diving mask and holding a pair of blue and white fins. He is looking towards the camera. The water is clear and blue, with light rays filtering through. The boy is wearing orange swim trunks.

**B** **BLUE**  
BY CRESSI

JUNIOR  
LINE



KIDS

BLUE BY CRESSI

# TINETTO ROCKS DRY SET

TINETTO MASK + DRY SNORKEL + ROCKS FINS

NEW 2024



The Tinetto Rocks Dry Set is perfect for young snorkelers eager to explore marine life. It features a single-lens mask with tempered glass for clarity, adjustable side buckles, a silicone skirt, and a split head strap for a secure, comfortable fit. The Iguana Dry snorkel has a dry top valve to prevent water entry, a snorkel keeper for mask attachment, a silicone mouthpiece to prevent jaw fatigue, and a bottom purge valve for easy water clearing. The Rocks fins reduce fatigue with vented blades and have rubber foot pockets for comfort. The easy-to-adjust buckles, thumb loop, and rubber foot pockets ensure a user-friendly experience.



BLUE NAVY/ICE CYAN



AQUAGREEN/WHITE



CODE	COLOR	SIZE	CASE PACK
SE252721	Blue Navy/Ice Cyan	S/M	10
SE252722	Blue Navy/Ice Cyan	L/XL	10
SE256331	Aqua Green/White	S/M	10
SE256332	Aqua Green/White	L/XL	10



SKIRT SIZE

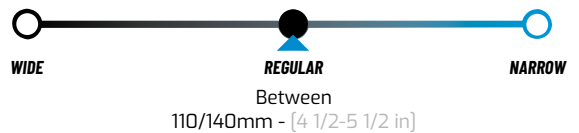

NOSE SIZE

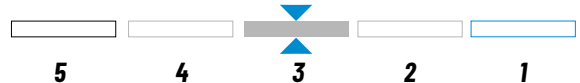

KIDS

# MINI BONETE PRO DRY SET

PEGASO MASK + IGUANA DRY SNORKEL + MINI BONETE FIN



LILAC/WHITE



BLUE/WHITE

The Mini Bonete set is a lightweight and colorful equipment, great for young snorkelers that want to have fun discovering the underwater world. Both mask and snorkel have parts made with soft and hypoallergenic silicone to ensure comfort and easy-to-use. The tempered glass ensures safety and a clear view. The mask's buckles are easy-to-use for length strap adjustment. The snorkel has a practical keeper to clip it to the mask's strap. The Mini Bonete are short open heel fins with adjustable straps. The foot pocket is easy to fit and comfortable. The design is made to ensure lightweight and relaxed finning.

CODE	COLOR	SIZE	CASE PACK
SE222031	Blue/White	S/M	5
SE222032	Blue/White	L/XL	5
SE224131	Lilac/White	S/M	5
SE224132	Lilac/White	L/XL	5

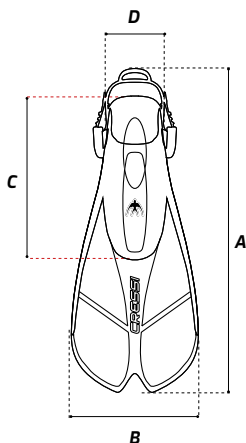

SIZE CONVERSION CHART					
FIN SIZE	EU FOOT SIZE	UK KID'S FOOT SIZE	US KID'S FOOT SIZE	KIDS AGE	FOOT LENGTH
S/M	26/32	8.5/12.5 k	4/6.5	2/5 YEARS	16-20 cm 6 1/3 - 8 1/8 in
L/XL	32/38	13k/5y	6.5/8	5/7 YEARS	20-24 cm 8 1/8 - 9 1/2 in

PRODUCT DIMENSION CHART				
A	B	C	D	FIN HEIGHT FIT
32.2 cm 12.7 in	15.5 cm 6.1 in	7.6 cm 3.0 in	8.5 cm 3.3 in	5.0 mm 2.0 in
35.0 cm 13.8 in	16.1 cm 6.3 in	8.2 cm 3.2 in	8.8 cm 3.5 in	5.2 mm 2.0 in

## TECHNICAL FEATURES

- Mask silicone skirt
- Tempered glass
- Snorkel dry top
- Purge valve
- Fins open heel
- Adjustable length strap

0	1	2	3	4	5	6	7	8	9	10	11	12	13	14	15	16
YEARS OLD																



FINS COULD COME LABELED WITH EU AND UK SIZES ONLY  
CRESSI'S SIZE CHART TO BE USED AS A REFERENCE ONLY

USA REV. 06/2023

### FIT SIZE



TO MAXIMIZE PERFORMANCE AND COMFORT, WEAR FINN WITH:

<input checked="" type="checkbox"/>	<input type="checkbox"/>	<input type="checkbox"/>	<input type="checkbox"/>
BARE FOOT	NEOPRENE SOCKS	NEOPRENE BOOTS (3 mm - 4, 5 mm - 7 mm)	HARD SOLE BOOTS (3 mm - 4, 5 mm - 7 mm)



**KIDS**

# BARON JUNIOR

WINDOW TO THE SEA



CLEAR/PINK



CLEAR/AQUA

CODE	COLOR	CASE PACK	SIZE
XDT0360026	Clear/Aqua	6	XS
XDT0360040	Clear/Pink	6	XS



## TECHNICAL FEATURES

- 30% larger viewing area, snorkelers can see all the underwater world has to offer without feeling claustrophobic
- Dry snorkel keeps water out, while a specialized deflector maximizes air circulation and eliminates fogging
- The valve's design gives the user effortless and natural breathing, with a wide breathing area around the nose and mouth
- Water draining valves safely remove any water that may enter the mask
- This mask is designed for surface use only and should not be used at depth
- Face skirt is made of soft hypoallergenic silicone for comfort and an excellent seal
- Two x-cross straps are easy to adjust for a perfect adaption to your head
- Frame and lens are made of polycarbonate material

0	1	2	3	4	5	6	7	8	9	10	11	12	13	14	15	16
YEARS OLD																



AVAILABLE FULL FACE MASK WALL

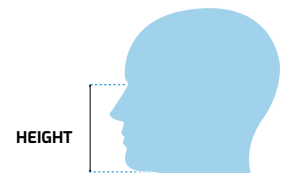

BARON JR DIMENSION CHART			
SIZE	HEIGHT (MM)	HEIGHT (IN)	KIDS AGE
XS/S	< 100	< 4	6-12 YEARS

CRESSI'S SIZE CHART TO BE USED AS A REFERENCE ONLY

USA REV. 06/2023



# ROMBO & MINI DRY NEW 2024

ROMBO MASK + MINI DRY SNORKEL



PINK/PINK-CLEAR/PINK



AZURE/AZURE-CLEAR/AZURE



LIME/AZURE-CLEAR/BLUE



2024 - CATALOG

Rombo is a frameless mask that boasts a low internal volume, making it excellent for freediving, snorkeling, or spearfishing. The design uses the assembly of the silicone skirt directly over a single tempered glass. This guarantees superb comfort and a perfect watertight seal. The Rombo's buckles are comfortable and effective, making adjustments quick and easy. The Mini Dry is a version of the Dry model

for kids. The snorkel has an original anti-splash end with a special valve that seals the tube as you dive, preventing the entrance of water when submerged. The lower end has a corrugated part that keeps the snorkel away from the mouth when not in use. A special water collection cup, with a large discharge valve makes expelling water quick and easy.

## TECHNICAL FEATURES

### MASK:

- Low volume, single lens design for a wide field of view
- Frameless: soft and comfortable silicone skirt bonds directly to the lens
- For lower weight and reduced drag
- Fast-adjust ratcheting strap buckles mounted to skirt
- High grade silicone seals
- Tempered glass lens

### SNORKEL

- Anti-splash end with automatically closing valve
- Ergonomic shape for maximum comfort
- Mouthpiece and corrugated part in hypoallergenic silicone
- Discharge cup for easy and quick emptying

CODE	COLOR	CASE PACK
DM390040	Pink/Pink-Clear/Pink	12
DM392202	Azure/Azure-Clear/Azure	12
DM396722	Lime/Azure-Clear/Blue	12

CRESSI

KIDS

# PEGASO & IGUANA DRY

PEGASO MASK + IGUANA DRY SNORKEL

0	1	2	3	4	5	6	7	8	9	10	11	12	13	14	15	16
YEARS OLD																



YELLOW/WHITE



BLUE/WHITE



LILAC/WHITE



The Pegaso & Iguana Dry combo is a lightweight option great for young snorkelers that want to discover the underwater world. Both mask and snorkel have parts made with soft and hypoallergenic silicone to ensure comfort and ease of use. The snorkel features a special valve that seals the tube when is submerged.

The tempered glass ensures safety and a clear view. The mask's buckles are easy-to-use for length strap adjustment. The dry snorkel has a silicone mouthpiece and a practical keeper to clip it to the mask's strap.



CODE	COLOR	CASE PACK
DM271030	Yellow/White	12
DM272030	Blue/White	12
DM274130	Lilac/White	12

SPARE PARTS

CODE	PRODUCT
DZ260030	Strap & Retainers White for Pegaso
DZ271030	Buckles Yellow/White for Pegaso
DZ272030	Buckles Blue/White for Pegaso
DZ274130	Buckles Lilac/White for Pegaso

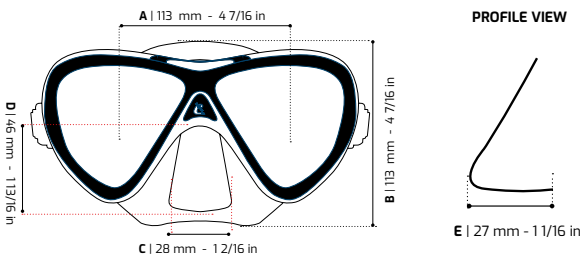

NOSE SIZE



PRODUCT DIMENSION CHART (SKIIRT SIZE)				
A - Width	B - Height	C- Nose Length	D- Nose Height	E- Nose Width
113 mm 4 7/16 in	113 mm 4 7/16 in	28 mm 1 2/16 in	46 mm 1 13/16 in	27 mm 1 1/16 in

CRESSI'S SIZE CHART IS TO BE USED AS A REFERENCE ONLY



**KIDS**



# TINETTO & IGUANA DRY

TINETTO MASK + IGUANA DRY SNORKEL

NEW 2024



BLUE NAVY/ICE CYAN

AQUA GREEN/WHITE



### TECHNICAL FEATURES

**MASK:**

- Tempered glass
- Single lens
- Adjustable buckles
- Silicone skirt
- Split head strap

**SNORKEL**

- Dry top valve system
- Quick release snorkel keeper
- Bottom purge valve
- Silicone mouthpiece

CODE	COLOR	CASE PACK
DM452728	Blue Navy/Ice Cyan	12
DM456330	Aqua Green/White	12



**SKIRT SIZE**

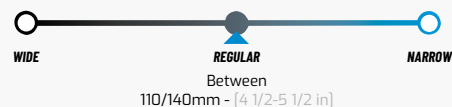

**NOSE SIZE**

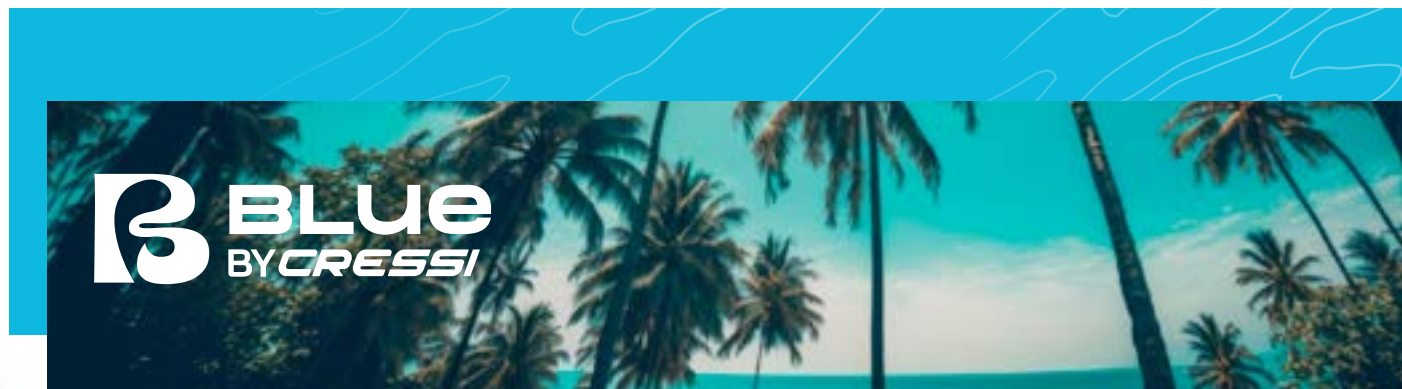

KIDS

# ONDINA & TOP

ONDINA MASK + TOP SNORKEL



0	1	2	3	4	5	6	7	8	9	10	11	12	13	14	15	16
YEARS OLD																

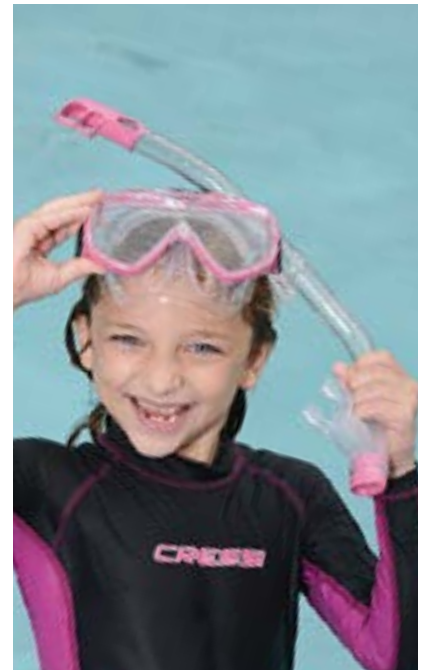

The Ondina mask is the smaller version of the Onda. It's a single tempered lens mask suitable for young water lovers and is designed for snorkeling, swimming and scuba diving. The mask skirt is made from soft hypoallergenic transparent silicone with a double feathered edge that gives an excellent seal on many face types. The Top snorkel is a modern, small semi-dry snorkel, designed specifically for kids. The tube is made from a transparent, contoured and

flexible material. The quick-release snorkel keeper system allows height adjustment for comfort. The top end of the tube ends with a semi-dry splash-guard to prevent water from entering the tube even in rough water. The angled 100% high-quality silicone mouthpiece is designed for extreme comfort even during extended use. The top snorkel has a large internal elliptical one-way purge valve at the bottom for improved drainage.

CODE	COLOR	CASE PACK
DM1010131	Yellow	10
DM1010132	Blue	10
DM1010133	Aquamarine	10
DM1010134	Pink	10

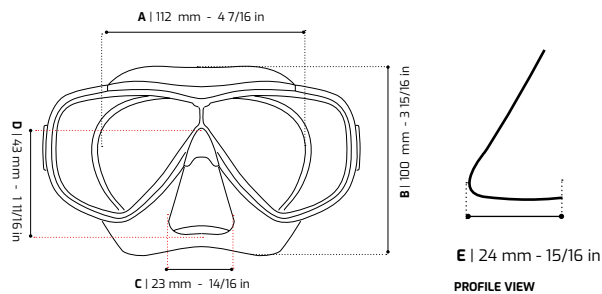
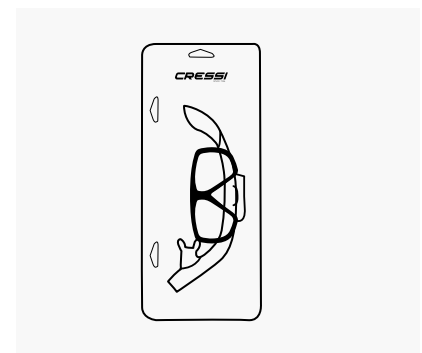

PRODUCT DIMENSION CHART (SKIRT SIZE)				
A - Width	B - Height	C - Nose Length	D - Nose Height	E - Nose Width
112 mm 4 7/16 in	100 mm 3 15/16 in	23 mm 14/16 in	43 mm 1 11/16 in	24 mm 15/16 in



KIDS



# TINETTO & MINI ISLAND

NEW 2024

TINETTO MASK + MINI ISLAND SNORKEL



CLEAR/BLUE

CLEAR/BLACK

The Tinetto & Mini-Island combo offers a straightforward and dependable choice for young snorkelers. The Tinetto features a single-tempered glass lens and user-friendly buckles for strap adjustments. Its silicone skirt ensures a perfect seal and the split head strap ensures comfortable wear. The Mini-Island snorkel is designed to minimize tube and mouthpiece bends for easier clearing. It includes a secure, built-in snorkel keeper for attachment to the mask, preventing loss while in the water. The silicone mouthpiece reduces jaw fatigue, and the wide-diameter snorkel tube ensures unobstructed breathing.

## TECHNICAL FEATURES

### MASK:

- Tempered glass
- Single lens
- Adjustable buckles
- Silicone skirt
- Split head strap

### SNORKEL

- Minimizing bends in the tube and mouthpiece makes clearing easier
- A secure keeper is provided to prevent losing the snorkel
- Mouthpiece is made of silicone
- Unobstructed breathing is made easy with the large diameter snorkel tube

CODE	COLOR	CASE PACK
DM460020	CLEAR/BLUE	12
DM460050	CLEAR/BLACK	12



### SKIRT SIZE

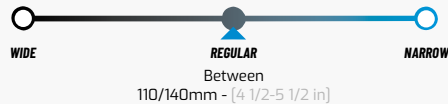

### NOSE SIZE

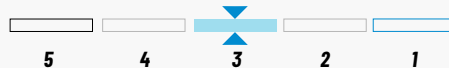



**KIDS**

# PEGASO & IGUANA

FROM 5 TO 15 YEARS | PEGASO MASK + IGUANA SNORKEL



**TECHNICAL FEATURES**

- MASK:**
- silicone skirt
  - Tempered glass
  - Adjustable length strap
- SNORKEL**
- Splash guard top
  - Purge valve

0	1	2	3	4	5	6	7	8	9	10	11	12	13	14	15	16
YEARS OLD																



The Pegaso & Iguana combo is a lightweight option great for young snorkelers that want to discover the underwater world. Both mask and snorkel have parts made with soft and hypoallergenic silicone to ensure comfort and ease of use. The tempered glass ensures safety and a clear view. The mask's buckles are easy-to-use for length strap adjustment. The snorkel has a practical keeper to clip it to the mask's strap.

CODE	COLOR	CASE PACK
DM261000	Yellow/Clear	10
DM262030	Blue/White	10
DM264130	Lilac/White	10

SPARE PARTS

CODE	PRODUCT
DZ260030	Strap & Retainers White for Pegaso
DZ271030	Buckles Yellow/White for Pegaso
DZ272030	Buckles Blue/White for Pegaso
DZ274130	Buckles Lilac/White for Pegaso

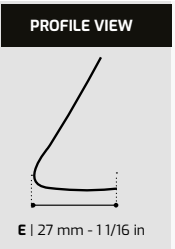
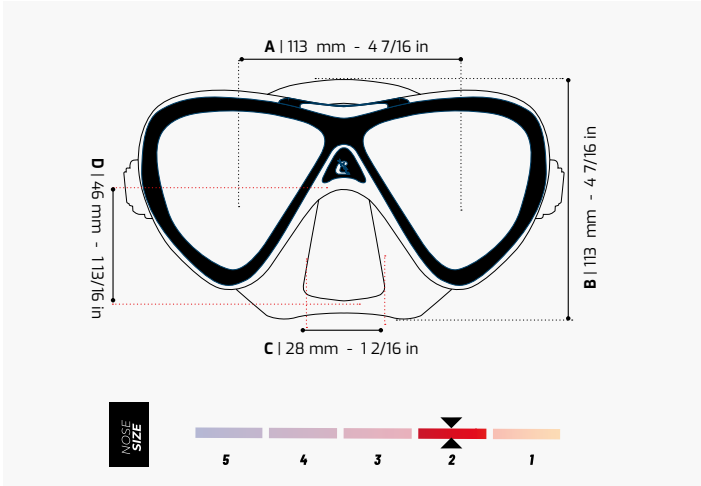

**PRODUCT DIMENSION CHART (SKIRT SIZE)**

A - Width	B - Height	C- Nose Length	D- Nose Height	E- Nose Width
113 mm 4 7/16 in	113 mm 4 7/16 in	28 mm 1 2/16 in	46 mm 1 13/16 in	27 mm 1 1/16 in

CRESSI'S SIZE CHART IS TO BE USED AS A REFERENCE ONLY

KIDS

# MAREA JUNIOR



CLEAR/YELLOW



CLEAR/BLUE



CLEAR/PINK

The Marea Junior is the smaller version of the Marea adult. It is a 2 windowed mask particularly suitable not only for snorkeling but also for scuba diving. It has dual tempered glass lenses, a double feathered skirt edge that adapts to most faces and a small inner volume that is perfect for going deep underwater.

The Marea Junior is made from 100% high quality sealing soft silicone that offers extraordinary and unprecedented comfort and fit. The mask is equipped with micrometric buckles to easily adjust the strap. Thanks to the silicone hand-nose pocket, it is easy to equalize the pressure even wearing gloves.

### TECHNICAL FEATURES

- 2-lens style mask
- Tempered glass lenses
- Micrometric adjustable buckles
- Double feathered skirt edge
- Skirt and strap made of hypoallergenic silicone
- Split strap

2024 - CATALOG

CODE	COLOR	CASE PACK
DN283010	Clear/Yellow	12
DN283020	Clear/Blue	12
DN283040	Clear/Pink	12

#### SPARE PARTS

CODE	PRODUCT
DZ210020	Buckles Black for Estrella/Marea/Marea Jr/Sky/Sky Jr/Ocean
DZ210040	Silicone Strap Clear for Sea Line Masks
DZ210042	Silicone Strap Black for Sea Line Masks

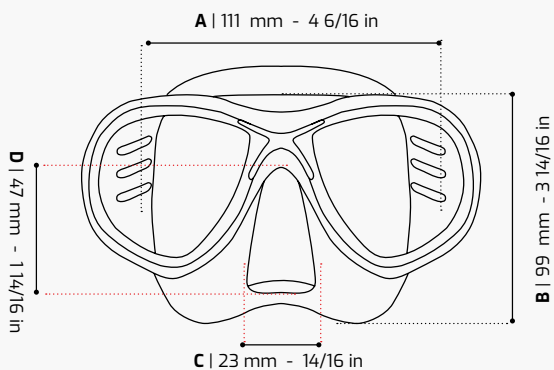

NOSE SIZE

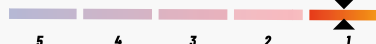

#### PROFILE VIEW

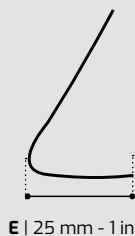

### PRODUCT DIMENSION CHART (SKIRT SIZE)

A - Width	B - Height	C - Nose Length	D - Nose Height	E - Nose Width
111 mm 4 6/16 in	99 mm 3 14/16 in	23 mm 14/16 in	47 mm 1 14/16 in	25 mm 1 in

CRESSI'S SIZE CHART IS TO BE USED AS A REFERENCE ONLY

CRESSI

**KIDS**

# PERLA JUNIOR

AGE 7-13



**TECHNICAL FEATURES**

- 2-lens style mask
- Tempered glass lenses
- Micrometric adjustable buckles
- Double feathered skirt edge
- Skirt and strap made of hypoallergenic silicone
- Split strap



CLEAR/BLUE

CLEAR/PINK

CLEAR/AQUAMARINE

CLEAR/LIME

CODE	COLOR	CASE PACK
DN208420	Clear/Blue	12
DN208440	Clear/Aqua	12
DN208463	Clear/Pink	12
DN208467	Clear/Lime	12

SPARE PARTS

CODE	PRODUCT
DZ210005	Buckles Black Pair for Onda/Ondina/Perla/Pumetta/Sirena
DZ210040	Silicone Strap Clear for Sea Line Masks
DZ210042	Silicone Strap Black for Sea Line Masks

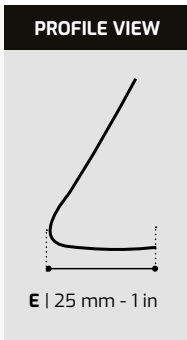
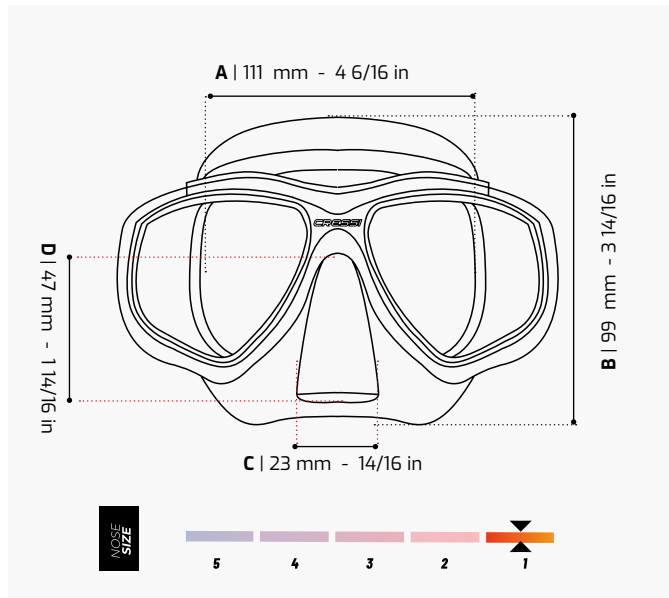
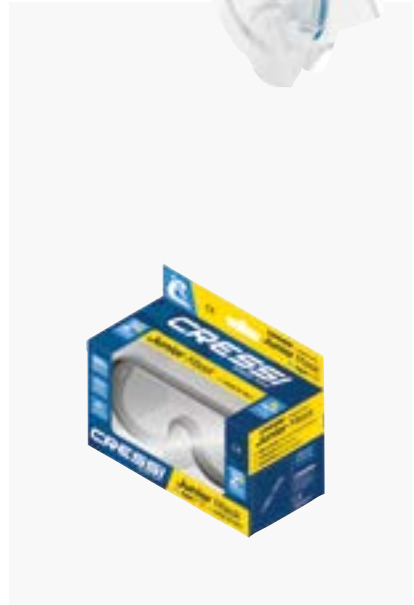

**PRODUCT DIMENSION CHART (SKIRT SIZE)**

A - Width	B - Height	C - Nose Length	D - Nose Height	E - Nose Width
111 mm 4 6/16 in	99 mm 3 14/16 in	23 mm 14/16 in	47 mm 1 14/16 in	25 mm 1 in

CRESSI'S SIZE CHART IS TO BE USED AS A REFERENCE ONLY



KIDS

# PIUMETTA

AGE 3-7



**TECHNICAL FEATURES**

- Mono-lens style mask
- Polycarbonate lens
- Micrometric adjustable buckles
- Double feathered skirt edge
- Skirt and strap made of hypoallergenic silicone
- Split strap



YELLOW

BLUE

PINK

AQUAMARINE

CODE	COLOR	CASE PACK
DN200510	Clear/Yellow	12
DN200520	Clear/Blue	12
DN200540	Clear/Pink	12
DN200563	Clear/Aqua	12

SPARE PARTS

CODE	PRODUCT
DZ210005	Buckles Black Pair for Onda/Ondina/Perla/Pumetta/Sirena
DZ210040	Silicone Strap Clear for Sea Line Masks
DZ210042	Silicone Strap Black for Sea Line Masks

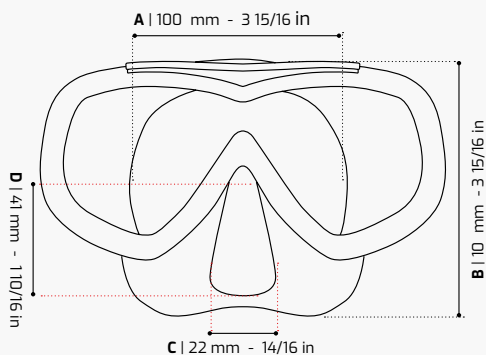
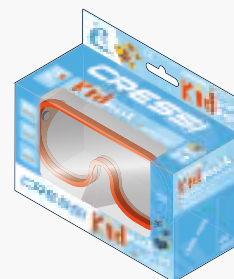

PROFILE VIEW

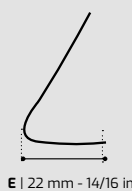

**PRODUCT DIMENSION CHART (SKIRT SIZE)**

A - Width	B - Height	C- Nose Length	D- Nose Height	E- Nose Width
100 mm 3 15/16 in	100 mm 3 15/16 in	22 mm 14/16 in	41 mm 1 10/16 in	22 mm 14/16 in

CRESSI'S SIZE CHART IS TO BE USED AS A REFERENCE ONLY

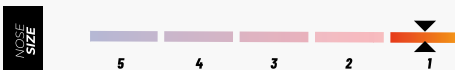

KIDS

# MOON

AGE 5-10



The Moon is a small mask suitable for children. The mask is really more comfortable, compared to the traditional swim goggles, and are ideal to be used in the swimming pool even in the sea with a snorkel.

The two lenses have a design that follows the natural shape of the face drastically increasing the field of view. They are made with anti-scratch and anti-fog treatment. They also protect the eyes against the dangerous UV sun rays.

The skirt is made of hypoallergenic TPR, a soft material that ensures comfort. The front frame is made of very flexible plastic and, in combination with the TPR, the mask ensures a perfect seal and adapts to most shape faces.. The nose pocket is easy-to-reach for ear equalization if the child swims below the surface of the water.

The buckles are the same used in the Cressi premium scuba diving mask and allow the user to easily adjust the strap length without effort.

CODE	COLOR	CASE PACK
DN200620	CLEAR/AZURE	12
DN200641	CLEAR/LILAC	12
DN200667	CLEAR/LIME	12
DN200720	LIGHT BLUE/LIME	12
DN200740	PINK/LILAC	12

SPARE PARTS

CODE	PRODUCT
DZ300060	BUCKLES CLEAR FOR SWIM GOGGLES
DZ301020	SWIM GOGGLES SILICONE STRAP BLUE
DZ301040	SWIM GOGGLES SILICONE STRAP PINK
DZ301060	SWIM GOGGLES SILICONE STRAP CLEAR

TECHNICAL FEATURES

- Swim mask style
- Polycarbonate lens
- Micrometric adjustable buckles
- Skirt and strap made of hypoallergenic silicone
- Split strap

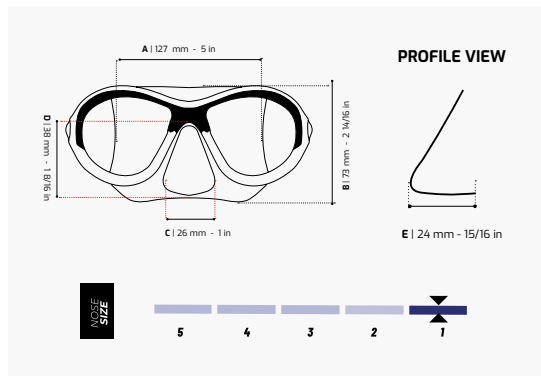

CRESSI'S SIZE CHART IS TO BE USED AS A REFERENCE ONLY



**KIDS**

# MINI DRY

Version of the Supernova Dry model for kids. The Mini Dry snorkel has an original anti-splash end with a special valve that seals the tube as you dive, almost totally preventing the entrance of water as the snorkel is submerged. The lower end has a corrugated part that is smooth on the inside and keeps the snorkel away from the mouth when using a breathing apparatus. A special water collection cup, with a large elliptic discharge valve, makes expelling water quick and easy.



### TECHNICAL FEATURES

- Top with floating valve that seals the tube while submerged
- Splash-guard top
- Corrugated tube made of flexible silicone
- Angled mouthpiece for reducing jaw fatigue
- Replaceable mouthpiece made of hypoallergenic silicone
- Lower purge valve for blowing out excess of water
- Quick-release snorkel keeper

0	1	2	3	4	5	6	7	8	9	10	11	12	13	14	15	16
YEARS OLD																

2024 - CATALOG



YELLOW      BLUE      PINK      LILAC      BLACK

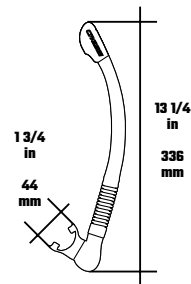

CODE	COLOR	CASE PACK
ES258810	YELLOW	10
ES258820	BLUE	10
ES258840	PINK	10
ES258841	LILAC	10
ES258850	BLACK	10

#### SPARE PARTS

CODE	PRODUCT
EZ267018W	Snorkel keeper White for Supernova Dry/Mini Dry/Tao/Tao Dry
DZ301020	Mouthpiece Clear for Mini Dry

**CRESSI**

**KIDS**

# TOP

MADE IN ITALY



### TECHNICAL FEATURES

- Semi-dry style snorkel
- Splash guard helps minimize water entry from splashing or waves
- High-quality silicone mouthpiece is comfortable and durable
- Angled mouthpiece reduces jaw fatigue
- Lower purge valve allows water to be quickly expelled
- Adjustable clip for securing to any mask

0	1	2	3	4	5	6	7	8	9	10	11	12	13	14	15	16
YEARS OLD																

CODE	COLOR	CASE PACK
ES269063	Clear/Aqua	6
ES269120	Blue/Clear	6
ES269140	Pink/Clear	6

SPARE PARTS

CODE	PRODUCT
EZ267011	Snorkel keeper Clear for Top
EZ270036	Mouthpiece Clear for Top

# MINI ISLAND



### TECHNICAL FEATURES

- Minimal tube and mouthpiece bends provides easier clearing capability.
- Fixed keeper that prevents loss during snorkeling
- The multi-positional silicone soft mouthpiece provides extreme comfort during prolonged use
- Large diameter snorkel tube provides unobstructed ease of breathing

0	1	2	3	4	5	6	7	8	9	10	11	12	13	14	15	16
YEARS OLD																

CODE	COLOR	CASE PACK
ZEG265500	Clear/Yellow	10
ZEG265550	Black/Yellow	10



KIDS

# CLIO



BLUE



YELLOW



### TECHNICAL FEATURES

- Above BLADE foot pocket
- Long blade
- Ideal for rental



Simple to use and highly durable. This fin has become an Icon over the last decades because it is everyone's favorite snorkel and rental fin. It is a combination of a responsive blade and a soft but strong foot pocket. The fin is a great bargain for your retail shop, and with youth through adult sizes, it is an excellent choice for your rental department.

CRESSI'S SIZE CHART IS TO BE USED AS A REFERENCE ONLY

FIN SIZE	PRODUCT DIMENSION CHART					SIZE		
	A LENGTH	B WIDTH	C LENGTH FIT	D WIDTH FIT	FIN HEIGHT FIT	EU FIN SIZE	UK FOOT SIZE	US KID FOOTSIZE
30/32	405 MM 16 IN	155 MM 6.1 IN	180 MM 7 IN	80 MM 3.2 IN	46 MM 1.8 IN	30/32	11.5 / 13 KID	12 / 13.5 KID
33/34	470 MM 15.5 IN	165 MM 6.5 IN	205 MM 8.1 IN	84 MM 3.3 IN	59 MM 2.3 IN	33/34	1 / 2	1.5 / 2.5

CODE	COLOR	SIZE	CASE PACK
CA101030	Yellow	30/32	6
CA101033	Yellow	33/34	6
CA102030	Blue	30/32	6
CA102033	Blue	33/34	6

KIDS

# ROCKS



### TECHNICAL FEATURES

- Foot pocket made of comfortable rubber
- Large thumb loop
- Push-button buckles to easily adjust strap length
- Blade designed to reduce leg cramps

0	1	2	3	4	5	6	7	8	9	10	11	12	13	14	15	16
YEARS OLD																



The Rocks are a composite-design, vented open heel fins with adjustable straps designed to follow the kid's growth. The straps have the large-thumb-loop for easy donning and doffing. Dual composite vented blades provide excellent power and energy saving efficiency. All in all, these fins are great for family snorkel trips and will allow hours of underwater exploration.

CODE	COLOR	SIZE	CASE PACK
CA262031	Blue/White	S/M	10
CA262032	Blue/White	L/XL	10
CA264131	Lilac/White	S/M	10
CA264132	Lilac/White	L/XL	10

#### SPARE PARTS

CODE	PRODUCT
CZ242030	Strap & Buckles assembly Blue/White for Mini Bonete/Rocks
CZ244130	Strap & Buckles assembly Lilac/White for Bonete/Rocks



SIZE CONVERSION CHART					
FIN SIZE	EU FOOT SIZE	UK KID'S FOOT SIZE	US KID'S FOOT SIZE	KIDS AGE	FOOT LENGTH
S/M	26/32	8.5/12.5 k	4/6.5	3/5 YEARS	16-20 cm 6 1/3 - 8 1/8 in
L/XL	32/38	13k/5y	6.5/8	6/10 YEARS	20-24 cm 8 1/8 - 9 1/2 in

PRODUCT DIMENSION CHART				
A	B	C	D	FIN HEIGHT FIT
348 mm 13.7 in	170 mm 6.7 in	188 mm 7.4 in	79 mm 3.2 in	58 mm 2.3 in
379 mm 14.9 in	177 mm 7 in	205 mm 8.1 in	87 mm 3.5 in	59 mm 2.4 in

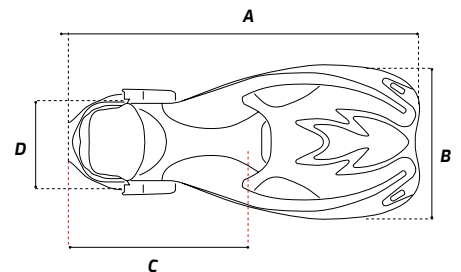

FINS COULD COME LABELED WITH EU AND UK SIZES ONLY  
CRESSI'S SIZE CHART TO BE USED AS A REFERENCE ONLY

#### FIT SIZE



TO MAXIMIZE PERFORMANCE AND COMFORT, WEAR FINN WITH:

<input checked="" type="checkbox"/>	<input type="checkbox"/>	<input type="checkbox"/>	<input type="checkbox"/>
BARE FOOT	NEOPRENE SOCKS	NEOPRENE BOOTS 3 mm - 6 mm - 7 mm	HARD SOLE BOOTS 3 mm - 5 mm - 7 mm

**KIDS**

# MED X JUNIOR

2.5 mm

One-piece shorty in 3 mm double-lined neoprene. Perfect for snorkeling, dives in tropical waters, swimming, sailing, and water sports in general. Lightweight and easy to put on, it offers excellent freedom of movement.



### TECHNICAL FEATURES

- Double-lined neoprene
- Rubberized neoprene on the chest
- 120° anatomic shape neck closure
- Adjustable collar with Velcro closure
- Anatomical cuts for free movements
- Shorty style

0	1	2	3	4	5	6	7	8	9	10	11	12	13	14	15	16
YEARS OLD																



### PRODUCT SIZE CHART

SIZE	AGE	WEIGHT (lb)	WEIGHT (kg)	HEIGHT (in)	HEIGHT (cm)	WAIST (in)	WAIST (cm)
3XS	2 - 3	22 - 31	10 - 14	33 - 37	85 - 95	19	48
2XS	4 - 5	33 - 40	15 - 18	38 - 45	95 - 115	21	54
XS	6 - 7	41 - 55	18 - 25	45 - 52	115 - 132	23	58.5
S	8 - 9	55 - 66	25 - 30	50 - 54	127 - 137	23 1/2	60
M	10 - 11	66 - 88	30 - 40	51 - 56	130 - 142	24	61
L	12 - 13	88 - 110	40 - 50	54 - 58	137 - 147	25 1/2	65

CODE	COLOR	SIZE	CASE PACK
LV438509	Black/Pink	3XS	10
LV438500	Black/Pink	2XS	10
LV438501	Black/Pink	XS	10
LV438502	Black/Pink	X	10
LV438503	Black/Pink	M	10
LV438504	Black/Pink	L	10
LV438011	Black/Blue	3XS	10
LV438012	Black/Blue	2XS	10
LV438001	Black/Blue	XS	10
LV438002	Black/Blue	X	10
LV438003	Black/Blue	M	10
LV438004	Black/Blue	L	10

**KIDS**

# LIDO JUNIOR

2 mm

The easy-entry front zipper placement makes the Lido effortless to put on and take off. It's perfect for snorkeling, diving in tropical waters, swimming, sailing and other activities. Highly flexible 2 mm neoprene and a flattering cut conforms easily to most body shapes for a great fit.



**PRODUCT SIZE CHART**

SIZE	AGE	WEIGHT (lb)	WEIGHT (kg)	HEIGHT (in)	HEIGHT (cm)	WAIST (in)	WAIST (cm)
3XS	2 - 3	22 - 31	10 - 14	33 - 37	85 - 95	19	48
2XS	4 - 5	33 - 40	15 - 18	38 - 45	95 - 115	21	54
XS	6 - 7	41 - 55	18 - 25	45 - 52	115 - 132	23	58.5
S	8 - 9	55 - 66	25 - 30	50 - 54	127 - 137	23 1/2	60
M	10 - 11	66 - 88	30 - 40	51 - 56	130 - 142	24	61
L	12 - 13	88 - 110	40 - 50	54 - 58	137 - 147	25 1/2	65

CODE	COLOR	SIZE
LV458009	Blue	3XS
LV458000	Blue	2XS
LV458001	Blue	S
LV458002	Blue	XS
LV458003	Blue	M
LV458004	Blue	L
LV458409	Pink	3XS
LV458400	Pink	2XS
LV459001	Pink	S
LV459002	Pink	XS
LV459003	Pink	M
LV459004	Pink	L

**TECHNICAL FEATURES**

- Separate anatomical cuts for both boy and girl
- Double-lined neoprene for durability and warmth
- Front zip entry for easier donning
- Shorty style

0	1	2	3	4	5	6	7	8	9	10	11	12	13	14	15	16
YEARS OLD																





**KIDS**

# KIDS SWIMSUIT

## 1.5 mm - LONG SLEEVE

One-piece swimsuit for little children ideal for any kind of water activity. It is a must-have for the swimming pool or to go snorkeling in the sea. The wetsuit works like a second skin, protecting

against the harmful sun ray and against jellyfishes. Lightweight and easy to put on, it offers excellent freedom of movement.

### TECHNICAL FEATURES

- Long sleeves, short legs style
- Chest, back and legs fabric: 1.5 mm Neoprene
- Sleeves, collar and colored axillary section fabric: Elastane
- Front YKK zipper
- Great sun UV-rays protection: UPF 50+
- Jellyfish protection

0	1	2	3	4	5	6	7	8	9	10	11	12	13	14	15	16
YEARS OLD																



SUN&COLD protection



JELLYFISH protection

### PRODUCT SIZE CHART

SIZE	AGE	WEIGHT (lb)	WEIGHT (kg)	HEIGHT (in)	HEIGHT (cm)
S	1 - 2	22 - 29 lb	10.0 - 13.1 kg	30 - 33 in	76.2 - 83.8 cm
M	3 - 4	29 - 46 lb	13.1 - 20.9 kg	33 - 43 in	83.2 - 109.2 cm
L	5 - 6	46 - 57 lb	20.9 - 25.6 kg	43 - 47 in	109.2 - 119.4 cm
XL	7 - 8	57 - 71 lb	25.6 - 32.2 kg	47 - 53 in	119.4 - 134.6 cm
2XL	9 - 10	71 - 85 lb	32.2 - 38.6 kg	53 - 57 in	134.6 - 144.8 cm

CODE	COLOR	SIZE	CASE PACK
WDG001541	Black/Pink	S	5
WDG001542	Black/Pink	M	5
WDG001543	Black/Pink	L	5
WDG001544	Black/Pink	XL	5
WDG001545	Black/Pink	2XL	5
WDG001501	Black/Blue	S	5
WDG001502	Black/Blue	M	5
WDG001503	Black/Blue	L	5
WDG001504	Black/Blue	XL	5
WDG001505	Black/Blue	2XL	5

**KIDS**

# KIDS SWIMSUIT

1.5 mm - SHORT SLEEVE

One-piece swimsuit for little children ideal for any kind of water activity. It is a must-have for the swimming pool or to go snorkeling in the sea. The wetsuit works like a second skin, protecting

against the harmful sun ray and against jellyfishes. Lightweight and easy to put on, it offers excellent freedom of movement.



SUN & COLD protection



JELLYFISH protection



**PRODUCT SIZE CHART**

SIZE	AGE	WEIGHT (lb)	WEIGHT (kg)	HEIGHT (in)	HEIGHT (cm)
S	1 - 2	22 - 29 lb	10.0 - 13.1 kg	30 - 33 in	76.2 - 83.8 cm
M	3 - 4	29 - 46 lb	13.1 - 20.9 kg	33 - 43 in	83.2 - 109.2 cm
L	5 - 6	46 - 57 lb	20.9 - 25.6 kg	43 - 47 in	109.2 - 119.4 cm
XL	7 - 8	57 - 71 lb	25.6 - 32.2 kg	47 - 53 in	119.4 - 134.6 cm
2XL	9 - 10	71 - 85 lb	32.2 - 38.6 kg	53 - 57 in	134.6 - 144.8 cm

CODE	COLOR	SIZE	CASE PACK
DG001001	Blue/Azure	S	5
DG001002	Blue/Azure	M	5
DG001003	Blue/Azure	L	5
DG001004	Blue/Azure	XL	5
DG001005	Blue/Azure	2XL	5
DG001101	Pink	S	5
DG001102	Pink	M	5
DG001103	Pink	L	5
DG001104	Pink	XL	5
DG001105	Pink	2XL	5

**TECHNICAL FEATURES**

- Shorty style
- Chest, back and legs fabric: 1.5 mm Neoprene
- Sleeves, collar and colored axillary section fabric: Elastane
- Front YKK zipper
- Great sun UV-rays protection: UPF 50+
- Jellyfish protection

0	1	2	3	4	5	6	7	8	9	10	11	12	13	14	15	16
YEARS OLD																



**KIDS**

# MINI COBRA



CLEAR/BLUE

CLEAR/BLUE, BLUE LENS

**RECOMMENDED FOR OUTDOORS**



CLEAR/PINK

CLEAR/LIME



LIGHT BLUE/LIME

The Mini Cobra is designed for kids, for swimming and enjoying the sea. Made of silicone, a better and longer-lasting material than plastic PVC. This material is more comfortable and allows a perfect fit for most facial profiles. The mask is made with a single-piece skirt that is characterized by the presence of an elastic element within the structure that allows a better fit than other goggles. The lenses are shatterproof and made with an Anti-Scratch, UV Protection, and internal Anti-Fog treatment.

### TECHNICAL FEATURES

- Mask style swim goggles
- Skirt and strap made of hypoallergenic silicone
- Micrometrically adjustable buckles easy to reach
- Wide polycarbonate lenses
- Anti-UV, anti-fog, anti-scratch lenses
- Split strap

0	1	2	3	4	5	6	7	8	9	10	11	12	13	14	15	16
YEARS OLD																

CODE	COLOR	CASE PACK
DE202021	LIGHT BLUE/LIME	6
DE202022	CLEAR/BLUE	6
DE202023	CLEAR/BLUE, BLUE LENS	6
DE202040	CLEAR/PINK	6
DE202067	CLEAR/LIME	6

SPARE PARTS

CODE	PRODUCT
DZ300060	BUCKLES CLEAR FOR SWIM GOGGLES
DZ301020	SWIM GOGGLES SILICONE STRAP BLUE
DZ301060	SWIM GOGGLES SILICONE STRAP CLEAR

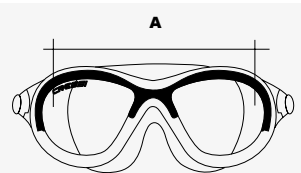

**DIMENSION CHART**

A | WIDTH

120 mm • 4 3/4 in



**KIDS**

# KING BALOO



AQUAMARINE/WHITE



BLUE/WHITE



PINK/WHITE



LILAC/WHITE

The King Baloo mono-lens goggle is designed for teens in order to allow any activity, also play, while maintaining excellent water tightness. The reduced skirt of its structure improves stability on the face as well as grip capacity.

CODE	COLOR	CASE PACK
DE203720	BLUE/WHITE	6
DE203725	AQUAMARINE/WHITE	6
DE203740	PINK/WHITE	6
DE203741	LILAC/WHITE	6

**TECHNICAL FEATURES**

- Total vision
- Micrometric adjustable buckles
- Ultra clear skirt
- 100% anti-UV lens
- Anti-scratch lens
- Anti-fog lens

0	1	2	3	4	5	6	7	8	9	10	11	12	13	14	15	16
YEARS OLD																





**KIDS**

# BALOO

The Baloo is the best seller mask in the Cressi swim line for kids, designed with extreme comfort in mind.

The mask has a flexible frame, a watertight fit, and easy adjusting buckles that make it the most comfortable and easy-to-use children's swim mask on the market today. It is perfect for swim lessons

and is the ultimate in aquatic eye protection. Because the lenses are curved, children do not feel claustrophobic. In addition, they are shatterproof, have an internal anti-fog treatment and are kid safe. The Baloo mask is the perfect solution for kids ready to experience the aquatic world.



### TECHNICAL FEATURES

- Mask style swim goggles
- Skirt and strap made of hypoallergenic silicone
- Micrometrically adjustable buckles easy to reach
- Wide curved lens to ensure a wide view and prevent claustrophobia while underwater
- Anti-UV, anti-fog, anti-scratch lens
- Split strap

0	1	2	3	4	5	6	7	8	9	10	11	12	13	14	15	16
YEARS OLD																

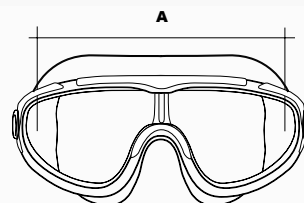

### PRODUCT DIMENSION CHART

A | WIDTH

117 mm • 4 5/8 in

CRESSI'S SIZE CHART IS TO BE USED AS A REFERENCE ONLY



CODE	COLOR	CASE PACK
DE203220	WHITE/BLUE	6
DE203222	LIGHT BLUE/LIME	6
DE203240	WHITE/PINK	6
DE203241	LILAC/WHITE	6
DE203267	GREEN/WHITE	6
DE203285	ORANGE/WHITE	6

#### SPARE PARTS

CODE	PRODUCT
DZ301030	SWIM GOGGLES SILICONE STRAP WHITE



KIDS

# KING CRAB

The sophisticated design of the King Crab goggles features uniquely shaped flat lenses that combine fashionable style with perfect vision underwater. The lenses are shatterproof and feature external anti-scratch treatment, UV protection, and internal anti-fog treatment. The King Crab goggles feature

comfortable TPR gaskets which form a watertight seal on the eyes and fit most facial profiles. The silicone strap and micro-adjustable buckle system are interchangeable with all the other masks and goggles in the Cressi Swim Line.

## TECHNICAL FEATURES

- Skirt made of high-quality TPR
- Split strap made of soft silicone
- Soft flexible nose bridge
- Slightly curved lenses for peripheral vision
- Anti-UV, anti-fog, anti-scratch lens
- Micrometrically adjustable buckles easy to reach

0	1	2	3	4	5	6	7	8	9	10	11	12	13	14	15	16
YEARS OLD																



PINK



LILAC



CLEAR



LIGHT BLUE



LIME/WHITE

CODE	COLOR	CASE PACK
DE202240	PINK	6
DE202241	LILAC	6
DE202260	CLEAR	6
DE202263	LIGHT BLUE	6
DE202267	LIME/WHITE	6

SPARE PARTS

CODE	PRODUCT
DZ300060	BUCKLES CLEAR FOR SWIM GOGGLES
DZ301020	SWIM GOGGLES SILICONE STRAP BLUE
DZ301030	SWIM GOGGLES SILICONE STRAP WHITE
DZ301040	SWIM GOGGLES SILICONE STRAP PINK
DZ301050	SWIM GOGGLES SILICONE STRAP BLACK
DZ301060	SWIM GOGGLES SILICONE STRAP CLEAR

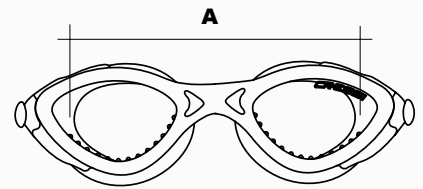

## PRODUCT DIMENSION CHART

A | WIDTH

114 mm • 4 1/2 in

CRESSI'S SIZE CHART IS TO BE USED AS A REFERENCE ONLY



**KIDS**

# ROCKS

NEW COLOR 2024

The Rocks are designed for young swimmers that need comfortable swim goggles for prolonged use.

They feature a classic round lens shape that is also slightly curved for excellent peripheral vision. Lenses feature external anti-scratch treatment, UV protection and internal anti-fog treatment. TPR gaskets around the lenses form a comfortable,

watertight seal. 100% hypoallergenic silicone strap for maximum comfort and fit. Strap and buckles are interchangeable with all other Cressi goggles and masks in the swim line. Offered in a variety of colors and lens tints, including a mirror lens version with black silicone.

## TECHNICAL FEATURES

- Skirt made of high-quality TPR
- Split strap made of soft silicone
- Soft flexible nose bridge
- Slightly curved lenses for peripheral vision
- Anti-UV, anti-fog, anti-scratch lens
- Micrometrically adjustable buckles easy to reach

0	1	2	3	4	5	6	7	8	9	10	11	12	13	14	15	16
YEARS OLD																



CODE	COLOR	CASE PACK
DE201321	BLUE/BLUE	6
<b>NEW</b> DE201322	AZURE/AZURE	6
DE201332	WHITE/BLUE	6
DE201334	WHITE/PINK	6
<b>NEW</b> DE201340	PINK/PINK	6
DE201360	CLEAR/CLEAR	6



### SPARE PARTS

CODE	PRODUCT
DZ300060	BUCKLES CLEAR FOR SWIM GOGGLES
DZ301020	SWIM GOGGLES SILICONE STRAP BLUE
DZ301030	SWIM GOGGLES SILICONE STRAP WHITE
DZ301060	SWIM GOGGLES SILICONE STRAP CLEAR

## PRODUCT DIMENSION CHART

A | WIDTH

115 mm • 4 1/2 in

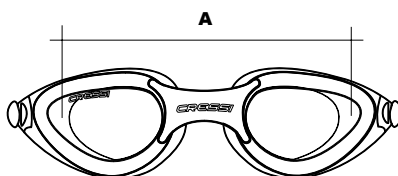

KIDS

# CRAB

Sophisticated silicone goggles designed for children aged approximately between 2 and 7 years old. Completely flat lenses for perfect vision, even at the edges.

Ideal for swim lessons. Shatterproof lenses with UV protection and scratch-resistant external treatment

and internal anti-fog treatment.

Cressi high technology for a perfect fit on most facial profiles and with great comfort. Interchangeable strap with patented micrometric, quick and easy adjustable buckles, similar to Cressi diving masks.



## TECHNICAL FEATURES

- Skirt made of high-quality TPR
- Split strap made of soft silicone
- Soft flexible nose bridge
- Slightly curved lenses for peripheral vision
- Anti-UV, anti-fog, anti-scratch lens
- Micrometrically adjustable buckles easy to reach

0	1	2	3	4	5	6	7	8	9	10	11	12	13	14	15	16
YEARS OLD																



CODE	COLOR	CASE PACK
DE203120	BLUE	6
DE203122	MATTE BLUE	6
DE203140	PINK	6
DE203141	LILAC	6
DE203160	CLEAR	6
DE203167	LIME	6
DE203161	CLEAR/BLUE	6

### SPARE PARTS

CODE	PRODUCT
DZ300060	BUCKLES CLEAR FOR SWIM GOGGLES
DZ301020	SWIM GOGGLES SILICONE STRAP BLUE
DZ301030	SWIM GOGGLES SILICONE STRAP WHITE
DZ301040	SWIM GOGGLES SILICONE STRAP PINK
DZ301041	SWIM GOGGLES SILICONE STRAP LILAC
DZ301050	SWIM GOGGLES SILICONE STRAP BLACK
DZ301060	SWIM GOGGLES SILICONE STRAP CLEAR



PRODUCT DIMENSION CHART
A   WIDTH
110 mm • 4 5/16 in

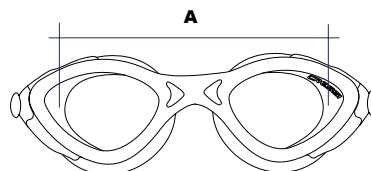

CRESSI'S SIZE CHART IS TO BE USED AS A REFERENCE ONLY



KIDS

# DOLPHIN 2.0

The Dolphin 2.0 are colorful goggles made for making your children happy. They're made with quality material to ensure comfort and a perfect

seal. The goggles feature easy to use buckles for adjusting the length of the strap. They come with a reusable protective box.



AZURE/  
YELLOW



AZURE/BLUE



AZURE/PINK



LILAC/WHITE

CODE	COLOR	CASE PACK
USG010210	AZURE/YELLOW	6
USG010220	AZURE/BLUE	6
USG010240	AZURE/PINK	6
USG010430	LILAC/WHITE	6



CODE	PRODUCT	CASE PACK
VAEKIDG	EMPTY	10

## TECHNICAL FEATURES

- Flat lens for perfect vision
- Shatterproof lenses
- Scratch resistant external treatment
- Internal anti-fog treatment

0	1	2	3	4	5	6	7	8	9	10	11	12	13	14	15	16
YEARS OLD																

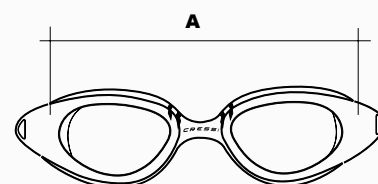

## PRODUCT DIMENSION CHART

A | WIDTH

102 mm • 4 in

CRESSI'S SIZE CHART IS TO BE USED AS A REFERENCE ONLY



KIDS

# SEAHORSE

Ideal for smaller faces, this classic swim goggle features soft silicone gaskets, a split silicone head strap and fog/UV protection. The Seahorse children's goggles showcase easy to adjust side

clips and an incremental size adjustable nosepiece that allows for custom fitting and comfort on the face.



BLUE/WHITE/RED



PURPLE/PINK



GREEN/AZURE



GREEN/WHITE/RED

CODE	COLOR	CASE PACK
XDE022038	BLUE/WHITE/RED	6
XDE023040	PURPLE/PINK	6
XDE029022	GREEN/AZURE	6
XDE029038	GREEN/WHITE/RED	6



CODE	PRODUCT	CASE PACK
VAEKIDG	EMPTY	10

## TECHNICAL FEATURES

- Flat lens for perfect vision
- Shatterproof lenses
- Scratch resistant external treatment
- Internal anti-fog treatment

0	1	2	3	4	5	6	7	8	9	10	11	12	13	14	15	16
YEARS OLD																

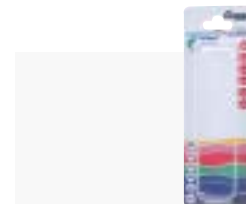

KIDS

# STARFISH

Ideal for smaller faces, this classic swim goggle features soft silicone gaskets, a split silicone head strap and fog/UV protection. The Starfish children's

goggles showcase easy to adjust side clips and an incremental size adjustable nosepiece that allows for custom fitting and comfort on the face.



BLUE/AZURE



GREEN/AZURE



ORANGE/AZURE



WHITE/PINK

CODE	COLOR	CASE PACK
XDE032022	BLUE/AZURE	6
XDE033040	WHITE/PINK	6
XDE038022	ORANGE/AZURE	6
XDE039022	GREEN/AZURE	6



CODE	PRODUCT	CASE PACK
VAEKIDG	EMPTY	10

## TECHNICAL FEATURES

- Anti-fog
- Panoramic lenses
- Cushioned silicone seals

0	1	2	3	4	5	6	7	8	9	10	11	12	13	14	15	16
YEARS OLD																



KIDS

# MINI LIGHT



YELLOW



AZURE



PINK



ORANGE



## TECHNICAL FEATURES

- Made of natural rubber (no latex)
- Soft and durable
- Floats on water
- Ideal for learning to swim

0	1	2	3	4	5	6	7	8	9	10	11	12	13	14	15	16
YEARS OLD																

The Mini Light will make learning to swim easy and fun for your child! Short kids fins made of high-quality rubber to ensure a proper comfort and fit. Designed for a daily use, flexible, comfortable and almost indestructible. The easy-to-use tab makes the fin easy to put on and take off. Ideal fins that help to develop leg strength and endurance.



CODE	COLOR	SIZE	CASE PACK
DP301023	YELLOW	23/24	30
DP301025	YELLOW	25/28	30
DP301029	YELLOW	29/31	30
DP301032	YELLOW	32/33	30
<b>NEW</b> DP301034	YELLOW	34/35	30
DP302123	AZURE	23/24	30
DP302125	AZURE	25/28	30
DP302129	AZURE	29/31	30
DP302132	AZURE	32/33	30
<b>NEW</b> DP302134	AZURE	34/35	30
DP304023	PINK	23/24	30
DP304025	PINK	25/28	30
DP304029	PINK	29/31	30
DP304032	PINK	32/33	30
<b>NEW</b> DP304034	PINK	34/35	30
DP308523	ORANGE	23/24	30
DP308525	ORANGE	25/28	30
DP308529	ORANGE	29/31	30
DP308532	ORANGE	32/33	30
<b>NEW</b> DP308534	ORANGE	34/35	30

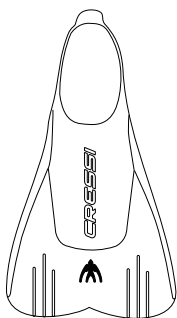

PRODUCT DIMENSION CHART			
FIN SIZE	EU FOOT SIZE	US FOOT SIZE	KID'S AGE
23 / 24	23 / 24	6 / 7.5 K	1/2 YEARS
25 / 28	25 / 28	8 / 11 K	2/5 YEARS
29 / 31	29 / 31	11.5 / 13 K	4/6 YEARS
32 / 33	32 / 33	13.5 K / 1 Y	6/7 YEARS
34 / 35	34 / 35	2 / 3 Y	8/9 YEARS

FINNS COME LABELED WITH EU AND UK SIZES ONLY  
CRESSI'S SIZE CHART IS TO BE USED AS A REFERENCE ONLY

**FIT SIZE**

RUNS SMALL | RUNS LARGE

To maximize performance and comfort, wear fins with:

<input checked="" type="checkbox"/>	<input checked="" type="checkbox"/>	<input type="checkbox"/>	<input type="checkbox"/>
BARE FOOT	NEOPRENE SOCKS	SPORTS SOCKS	WATER SHOES





KIDS

# BLOWFISH

NEW 2024

## WATERSHOES

Perfect water sport accessory for protecting your feet from scratches and abrasions.



### TECHNICAL FEATURES

- Anti-slip sole
- Drain holes on the top of the socks for better water removal



AZURE



PINK

CODE	COLOR	SIZE	CASE PACK
VB012220	AZURE	20/22	10
VB012223	AZURE	23/24	10
VB014020	PINK	20/22	10
VB014023	PINK	23/24	10



### CRESSI USA FIT SIZE

Runs Small

Runs Large

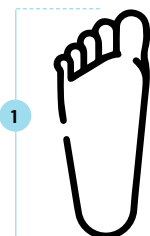

SIZE CHART				
SOCK SIZES	US SIZE	KIDS AGE	FOOT LENGTH CM	FOOT LENGTH INCHES
20/22	4 / 5.5	0/1 Y	12.3 cm - 13cm	4" 7/8 - 5" 1/8
23/24	6 / 7.5	1/2 Y	3.3 cm - 14.6 cm	5" 1/4 - 5" 3/4

USA 12/2023

CRESSI'S SIZE CHART TO BE USED AS A REFERENCE ONLY

**KIDS**

# GOGGLE STRAP COVER

MAKES THE SWIM GOGGLE FLOAT ON THE WATER SURFACE



PINK/PURPLE



AZURE/BLUE



GREY/AZURE



PURPLE/PINK



LIME/GREEN

CODE	COLOR	CASE PACK
D5339980	PINK/PURPLE	20
D5339982	AZURE/BLUE	20
D5339984	GREY/AZURE	20
D5339985	PURPLE/PINK	20
D5339986	LIME/GREEN	20

## TECHNICAL FEATURES

- Soft neoprene goggle strap covers with fun designs and Cressi logo.
- It offers comfort and helps to hold the goggle strap.

0	1	2	3	4	5	6	7	8	9	10	11	12	13	14	15	16
YEARS OLD																



# GOGGLE STRAP

# SWIFTY KID NEW 2024

SWIM CAP FROM 4 TO 8 YEARS



Colorful swim cap in stretch hypoallergenic silicone. Very durable, elastic, is not at risk of aging and the effects of chlorine.

CODE	COLOR
ZDF242422	NAVY/AZURE
ZDF243820	WHITE/RED/BLUE
ZDF244440	PURPLE/PINK
ZDF249380	GREEN/WHITE/RED



0	1	2	3	4	5	6	7	8	9	10	11	12	13	14	15	16
YEARS OLD																

2024 CATALOG

**KIDS**

# BABALOO REUSABLE DIAPER

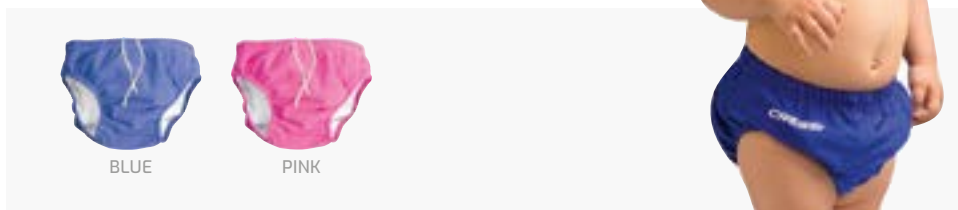

CODE	COLOR	SIZE
USD030100B	BLUE	XS
USD030101B	BLUE	S
USD030102B	BLUE	M
USD030103B	BLUE	L
USD030104B	BLUE	XL
USD030105B	BLUE	2XL (3T-4T)
USD030106B	BLUE	3XL (4T-5T)
USD040100P	PINK	XS
USD040101P	PINK	S
USD040102P	PINK	M
USD040103P	PINK	L
USD040104P	PINK	XL
USD040105P	PINK	2XL (3T-4T)
USD040106P	PINK	3XL (4T-5T)

SIZE	MONTHS	PRODUCT SIZE CHART			
		WEIGHT	WEIGHT	HEIGHT	HEIGHT
XS	3-6	6 - 12 LB	2.7-5.4 KG	25-27 IN	63.5-68.6 CM
S	6 - 9	9 - 18 LB	4.1 - 8.2 KG	27-29 IN	68.6-73.7 CM
M	9 - 12	15 - 24 LB	6.8-10.9 KG	29-31 IN	73.7-78.7 CM
L	12 - 18	22 - 29 LB	10.0-13.6 KG	31-33 IN	78.7-83.8 CM
XL	18 - 24	26 - 33 LB	11.8-15.0 KG	33-35 IN	83.8-88.9 CM
3T-4T	24 - 36	31 - 40 LB	14.1-18.1 KG	35-38 IN	88.9-94.0 CM
4T-5T	36 - 48	38 - 46 LB	17.2-20.9 KG	38 IN +	94.0-99.1 CM



**TECHNICAL FEATURES**

- Reusable swim diaper
- Comfortable fit
- Won't irritate the skin while swimming
- Sun ray protection: UV 50+

0	1	2	3	4	5	6	7	8	9	10	11	12	13	14	15	16
YEARS OLD																

\*\*\*\*\*

**MANDATORY**

IN SWIMMING POOL CLASSES!

SUN & COLD PROTECTION

NEW IMPROVED INTERNAL ABSORBENT FABRIC. HYPOALLERGENIC AND WASHABLE.



CRESSI

KIDS

# SUMBA XL



### TECHNICAL FEATURES

- Durable, tear-resistant fabric
- Water-repellent, stain-resistant fabric
- Lightweight and roomy
- Ventilated main compartment
- Volume: 25 L | 0.88 cu ft
- Dimensions: 40 x 70 cm | 15.7 x 27.5 in

### EASY CLOSURE



### FRONT POCKET

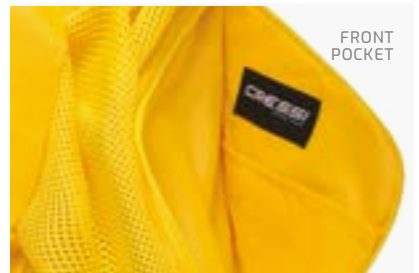

LIGHT BLUE



YELLOW

Sporty 25 Liters bag that's perfect for all activities and free time. Made in durable tear-resistant fabric with water-repellent and stain-resistant properties. Light and roomy, with cord closure and ample ventilated main compartment for clothing, an outer pocket for accessories, and zip closure.



CODE	COLOR
XUB950222	LIGHT BLUE
XUB950210	YELLOW





CRESSI SWIMMING

## 2024 COLLECTION

Cressi's Swim line is a world leader in aquatic swimwear and equipment, including suits, swim goggles, and other swim gear. Cressi is continually investing in research to develop innovative swimming gear for swimmers who just want to have fun and for those who demand high performance and quality from their swim gear. A range of light blues – think of the shimmering color of pool water – will define the brand personality of Cressi's Swim line, which offers products for kids to adults. The color blue can symbolize many things, including freedom, imagination inspiration, confidence, loyalty and trust, which are all things that define Cressi and its products.

**CRESSI**





**SWIMMING**

***FOLLOW  
YOUR  
MERMAID***



# FLASH

ADULT SIZE  
COMFORTABLE & PERFORMANCE

# MAN



The Flash goggles are characterized by an elastic nose bridge, which allows for perfect adaptability to a large number of facial profiles. The lenses are slightly inclined at 18° to follow the natural shape of the human face and increase the field of view. They are also shatterproof and offer UV ray protection. An internal anti-fogging treatment prevents fog during use. The eyes gaskets are made with hypoallergenic,

high-quality TPR to ensure comfort and a perfect seal. The double-strap is made of silicone to ensure a perfect fit without over-tightening. The Cressi-patented buckle system makes adjusting the strap effortless. Easy replacement of strap and buckle system. The Flash are versatile goggles, ideal for recreational swimming and competition, as well as both indoor and outdoor use.

### TECHNICAL FEATURES

- Comfortable leak proof eye gasket
- Flexible nose bridge fits various facial profiles
- Split strap made of soft and flexible silicone
- Eyes gaskets made of hypoallergenic, high-quality TPR
- Micrometrically adjustable buckles easy to reach
- Lenses: Inclined 18° anti fog, anti scratch, 100% anti UV

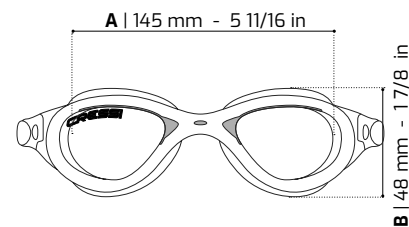

CODE	PRODUCT	CASE PACK
DE202320	FLASH - BLUE/BLUE	6
DE202322	FLASH - CLEAR/BLUE	6
DE202323	FLASH - CLEAR/BLUE + AZURE LENS	6
DE202331	FLASH - CLEAR/WHITE + TINTED LENS	6
DE202350	FLASH - CLEAR/BLACK	6
DE202358	FLASH - CLEAR/RED	6
DE2023757	FLASH - CLEAR/GREEN + MIRRORED LENS	6
DE202391	FLASH - BLACK/RED	6
DE202392	FLASH - BLACK/BLACK + TINTED LENS	6

### SPARE PARTS

CODE	PRODUCT
DZ300050	BUCKLES BLACK FOR SWIM GOGGLES
DZ300060	BUCKLES CLEAR FOR SWIM GOGGLES
DZ301020	SWIM GOGGLES SILICONE STRAP BLUE
DZ301050	SWIM GOGGLES SILICONE STRAP BLACK
DZ301060	SWIM GOGGLES SILICONE STRAP CLEAR

### REUSABLE PROTECTIVE BOX

13,5 x 21 cm  
5 5/16 x 8 1/4 in



# FLASH LADY

ADULT SIZE  
COMFORTABLE & PERFORMANCE



# LADY

The Flash Lady goggles are characterized by an elastic nose bridge, which allows for perfect adaptability to a large number of facial profiles. The lenses are slightly inclined at 18° to follow the natural shape of the human face and increase the field of view. They are also shatterproof and offer UV ray protection. An internal anti-fogging treatment prevents fog during use. The nose gasket is made with hypoallergenic, high-quality TPR to ensure comfort

and a perfect seal. The double-strap is made of silicone to ensure a perfect fit without over-tightening. The Cressi-patented buckle system makes adjusting the strap effortless. Easy replacement of strap and buckle system. The Flash are versatile goggles, ideal for recreational swimming and competition, as well as both indoor and outdoor use.



CLEAR/CLEAR BLUE

CLEAR/CLEAR PINK

CLEAR/CLEAR LILAC

CLEAR/CLEAR BLACK

BLACK/GRAY

CODE	COLOR	LENSES	CASE PACK
DE203020	CLEAR/BLUE	CLEAR	6
DE203040	CLEAR/PINK	CLEAR	6
DE203041	CLEAR/LILAC	CLEAR	6
DE203050	CLEAR/BLACK	CLEAR	6
DE202950	BLACK/GRAY	TINTED	6

#### SPARE PARTS

CODE	PRODUCT
DZ300060	BUCKLES CLEAR FOR SWIM GOGGLES
DZ301060	SWIM GOGGLES SILICONE STRAP CLEAR

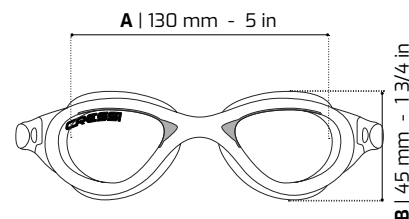



# RIGHT



# RIGHT

### TECHNICAL FEATURES

- Eyes gaskets made of hypoallergenic, high-quality TPR
- Split strap made of soft and flexible silicone
- Micrometrically adjustable buckles easy to reach
- Flexible nose bridge for perfect adaptability to a large number of facial profiles
- Lenses: Inclined 18° anti fog, anti scratch, 100% anti UV
- Ideal for recreational swimming

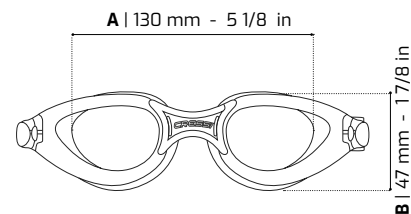

The Right are prestigious goggles with slightly curved lenses on the outer profile, to offer maximum visibility. The gasket is made with hypoallergenic, high-quality TPR to ensure comfort and a perfect seal. The double-strap is made of silicone to ensure a perfect fit without over-tightening. The Cressi-patented buckle

system makes adjusting the strap effortless. Easy replacement of strap and buckle system. The lenses are anti-scratch resistant, 100% UV protection, and anti-fog treated. The Right are versatile goggles recommended for recreational swimming, as well as both indoor and outdoor use.



BLUE/BLUE



BLACK/BLACK



CLEAR/CLEAR



BLUE METAL

CODE	COLOR	LENSES	CASE PACK
DE201621	BLUE/BLUE	CLEAR	6
DE201650	BLACK/BLACK	CLEAR	6
DE201660	CLEAR/CLEAR	CLEAR	6
DE2016555	BLUE METAL	CLEAR	6



REUSABLE PROTECTIVE BOX  
13,5 x 21 cm  
5 5/16 x 8 1/4 in



# FOX



# FOX



BLACK



CLEAR



LIGHT BLUE

The Fox goggles feature flat lenses for perfect vision, even at the edges. The gasket is made with hypoallergenic, high-quality TPR to ensure comfort and a perfect seal on most facial profiles. The double-strap is made of silicone to ensure a perfect fit without over-tightening. The Cressi-patented buckle system makes adjusting the strap effortless. Easy replacement of strap and buckle system. The lenses are anti-scratch resistant, 100% UV protection, and anti-fog treated. The Fox are versatile goggles recommended for recreational swimming, as well as both indoor and outdoor use.

## TECHNICAL FEATURES

- Flat lenses for perfect vision even at the edges
- Eyes gaskets made of hypoallergenic, high-quality TPR
- Split strap made of soft and flexible silicone
- Micrometrically adjustable buckles easy to reach
- Flexible nose bridge for perfect adaptability to a large number of facial profiles
- Lenses: Anti-fog, anti scratch, 100% anti UV
- Ideal for recreational swimming

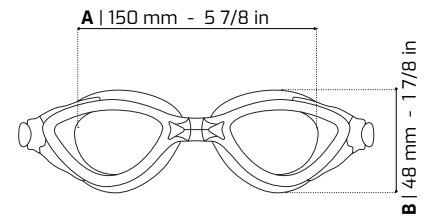

CODE	COLOR	CASE PACK	LENSES
DE202150	BLACK/BLACK	6	CLEAR
DE202160	CLEAR/CLEAR	6	CLEAR
DE202163	LIGHT BLUE/LIGHT BLUE	6	CLEAR

### SPARE PARTS

CODE	PRODUCT
DZ300050	BUCKLES BLACK FOR SWIM GOGGLES
DZ300060	BUCKLES CLEAR FOR SWIM GOGGLES
DZ301020	SWIM GOGGLES SILICONE STRAP BLUE
DZ301050	SWIM GOGGLES SILICONE STRAP BLACK
DZ301060	SWIM GOGGLES SILICONE STRAP CLEAR



# NUOTO 3.0 NEW 2024



### TECHNICAL FEATURES

- Antifog
- Quick-fit straps
- Wide view lenses
- Leakproof seal design
- 3 Adjustable nose bridges

The Nuoto 3.0 includes 3 different size nose bridges to accommodate different facial profiles. This ensures a leakproof design and comfort for each swimmer.



BLACK/BLACK  
MIRROR LENS



YELLOW/BLACK



NAVY/NAVY



PINK/CLEAR



CODE	COLOR	STYLE	CASE PACK
ZDE241050	YELLOW/BLACK	CLEAR	10
ZDE242424	NAVY/NAVY	CLEAR	10
ZDE244000	PINK/CLEAR	CLEAR	10
ZDE245059	BLACK/BLACK	MIRRORED LENS	10

# BLISS NEW 2024



### TECHNICAL FEATURES

- Special anti-fog coating
- Flat lenses
- Cushioned Silicone seals
- Adjustable nose bridge

The Bliss adjustable nose bridge to accommodate different facial profiles. This ensures a leakproof design and comfort for each swimmer.



NAVY/NAVY



WHITE/WHITE



WHITE/AQUA  
GREEN



BLACK/BLACK



CODE	COLOR	CASE PACK
ZDE232424	NAVY/NAVY	10
ZDE233030	WHITE/WHITE	10
ZDE233063	WHITE/AQUA GREEN	10
ZDE235050	BLACK/BLACK	10

# GALILEO

WITH TEMPERED GLASS LENSES



GALILEO



WHITE

BLACK

BLUE METAL

AQUAMARINE

The only swim goggles with tempered glass lenses! The Galileo has marked a new era in the sector of swimming goggles- perfect for any experience level. Their flat lenses are embedded in a rigid frame, as in underwater masks, guaranteeing perfect vision without any distortion while underwater. The soft skirt ensures a watertight seal as well as comfort. The strap is equipped with Cressi's patented quick adjustment system, similar to that used in the prestigious Cressi dive masks. The unbreakable lenses have an external anti-scratch and anti-UV treatment and an internal anti-fog treatment. See for yourself the difference a Cressi goggle can make!

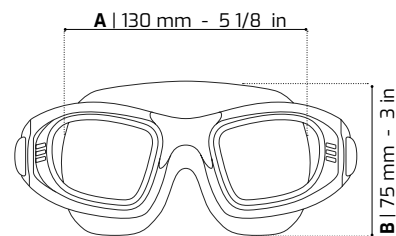

CODE	COLOR	LENSES	CASE PACK
DE205030	CLEAR/WHITE	CLEAR	6
DE205050	CLEAR/BLACK	CLEAR	6
DE205055	CLEAR/BLUE METAL	CLEAR	6
DE205599	CLEAR/AQUAMARINE	CLEAR	6

SPARE PARTS

CODE	PRODUCT
DZ300006	STRAP CLEAR FOR MINIMA/GALILEO



REUSABLE PROTECTIVE BOX  
13,5 x 21 cm  
5 5/16 x 8 1/4 in





# SKYLIGHT

MONO LENS TECHNOLOGY



SKYLIGHT

The Skylight swim mask has an innovative frame design, unique to Cressi. This mask uses mono-lens technology, ensuring maximum comfort without the irritation of a regular goggle. The innovative shape of the frame delivers a maximized peripheral view. The lenses are manufactured with an internal anti-fog treatment, are scratch-resistant, shatterproof, and 100% anti-UV. The lenses are

available in the mirrored and tinted versions, perfect for outdoor use. The silicone strap provides a secure and stable fit on the face for long periods in the water. Our patented easy-adjustable buckle system has made it among the very best, for many years. If you are looking for the ultimate swim mask in the market, the Cressi Skylight is the mask for you.

## TECHNICAL FEATURES

- Mono-lens technology ensures maximum comfort without the irritation of a regular goggle
- Maximized peripheral view
- Internal anti-fog treatment
- Scratch-resistant and shatterproof
- 100% anti-UV
- Silicone strap provides a secure and stable fit
- Patented easy-adjustable buckle system
- Perfect for open water and recreational swimming
- Available in mirrored and tinted lenses for outdoor swimming.

2024 - CATALOG



CLEAR/BLACK BLUE



CLEAR/WHITE BLUE



CLEAR/WHITE PINK



CLEAR/WHITE BLACK



BLUE METAL



CLEAR/BLACK GREY  
MIRRORED LENSES



BLACK/BLACK GREY  
MIRRORED LENSES



BLACK/BLACK  
SMOKED LENSES

CODE	COLOR	LENSES	CASE PACK
DE203320	CLEAR/BLACK/BLUE	CLEAR	6
DE203322	CLEAR/BLUE/WHITE	CLEAR	6
DE203340	CLEAR/PINK/WHITE	CLEAR	6
DE203350	CLEAR/BLACK/WHITE	CLEAR	6
DE203355	BLUE METAL	CLEAR	6
DE2033750	CLEAR/BLACK/GRAY	HD MIRRORED	6
DE203450	BLACK/BLACK/BLACK	TINTED	6
DE2034750	BLACK/BLACK/GRAY	HD MIRRORED	6

### SPARE PARTS

CODE	PRODUCT
DZ300050	BUCKLES BLACK FOR SWIM GOGGLES
DZ300060	BUCKLES CLEAR FOR SWIM GOGGLES

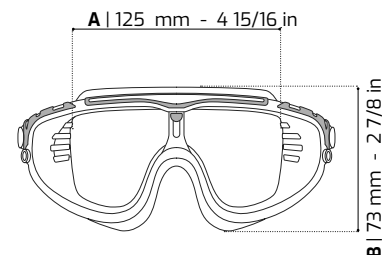

REUSABLE  
PROTECTIVE BOX  
13.5 x 21 cm  
5 5/16 x 8 1/4 in



CRESSI

# PLANET



# PLANET



CLEAR/WHITE/  
BLUE

CLEAR/WHITE/  
PINK



CLEAR/WHITE/  
LILAC

CLEAR/BLACK/  
SILVER



BLUE METAL

**RECOMMENDED FOR OUTDOORS**



CLEAR BLACK/  
SILVER  
TINTED LENSES

BLACK BLACK/  
RED  
TINTED LENSES

The Planet swim mask has an innovative frame design, unique to Cressi. This silicone mask features wide lenses, ensuring maximum comfort without the irritation of a regular goggle. The innovative shape of the frame delivers a maximized peripheral view. The lenses are manufactured with an internal anti-fog treatment, are scratch-resistant, shatterproof, and 100% anti-UV. The silicone strap provides a secure and stable fit on the face for long periods in the water. Our patented easy-adjustable buckle system has made it among the very best, for many years. If you are looking for the ultimate swim mask in the market, the Cressi Planet is the mask for you. Ideal for recreational and open-water swimming.

## TECHNICAL FEATURES

- Wide-lenses and soft silicone offer maximum comfort without the irritation of a regular goggle
- Maximized peripheral view
- Internal anti-fog treatment
- Scratch-resistant and shatterproof
- 100% anti-UV
- Silicone strap provides a secure and stable fit
- Patented easy-adjustable buckle system
- Available in tinted lenses, perfect for outdoor swimming



CODE	COLOR	LENSES	CASE PACK
DE202620	CLEAR - WHITE/BLUE	CLEAR	6
DE202640	CLEAR - WHITE/PINK	CLEAR	6
DE202641	CLEAR - WHITE/LILAC	CLEAR	6
DE202650	CLEAR - BLACK/SILVER	CLEAR	6
DE2026555	BLUE METAL	CLEAR	6
DE202651	CLEAR - BLACK/SILVER	TINTED	6
DE202758	BLACK - BLACK/RED	TINTED	6

## SPARE PARTS

CODE	PRODUCT
DZ300050	BUCKLES BLACK FOR SWIM GOGGLES
DZ300060	BUCKLES CLEAR FOR SWIM GOGGLES
DZ301050	SWIM GOGGLES SILICONE STRAP BLACK
DZ301060	SWIM GOGGLES SILICONE STRAP CLEAR

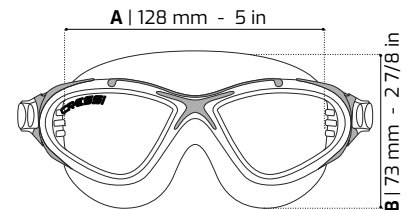

**REUSABLE PROTECTIVE BOX**  
13,5 x 21 cm  
5 5/16 x 8 1/4 in

# COBRA



CLEAR/BLUE



CLEAR/PINK



CLEAR/BLACK



BLACK/RED



CLEAR/WHITE



BLACK/BLACK

The Cobra swim mask has an innovative frame design, unique to Cressi. This mask features wide lenses, ensuring maximum comfort without the irritation of a regular goggle. The innovative shape of the frame delivers a maximized peripheral view. The lenses are manufactured with an internal anti-fog treatment, are scratch-resistant, shatterproof, and 100% anti-UV. The silicone strap provides a secure and stable fit on the face for long periods in the water. Our patented easy-adjustable buckle system has made it among the very best, for many years. Available with tinted lenses, perfect for outdoor swimming. If you are looking for the ultimate swim mask in the market, the Cressi Cobra is the mask for you.

## TECHNICAL FEATURES

- Ideal for smaller facial profiles
- Wide-lenses and offer maximum comfort without the irritation of a regular goggle
- Maximized peripheral view
- Internal anti-fog treatment
- Scratch-resistant and shatterproof
- 100% anti-UV
- Silicone strap provides a secure and stable fit
- Patented easy-adjustable buckle system
- Available with tinted lenses, perfect for outdoor swimming

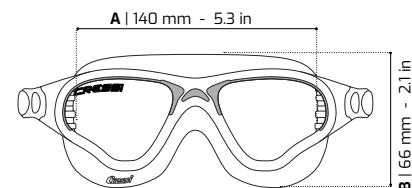

CODE	COLOR	LENSES	CASE PACK
DE201922	CLEAR/BLUE	CLEAR	6
DE201940	CLEAR/PINK	CLEAR	6
DE201950	CLEAR/BLACK	CLEAR	6
DE201991	BLACK/RED	CLEAR	6
DE201931	CLEAR/WHITE	TINTED	6
DE201992	BLACK/BLACK	TINTED	6

### SPARE PARTS

CODE	PRODUCT
DZ300050	BUCKLES BLACK FOR SWIM GOGGLES
DZ300060	BUCKLES CLEAR FOR SWIM GOGGLES
DZ301050	SWIM GOGGLES SILICONE STRAP BLACK
DZ301060	SWIM GOGGLES SILICONE STRAP CLEAR



REUSABLE PROTECTIVE BOX  
13,5 x 21 cm  
5 5/16 x 8 1/4 in

# NOSE CLIP

The Nose Clip is a must-have for swim lovers. It prevents water from entering your nose while swimming. With a lightweight, waterproof design, this nose clip provides a low-profile, comfortable fit. Perfect for all kinds of training and competition but also for leisure. One size that fits both youth and adults. Includes a small case for easy storage.

CODE
DF200189





# SUPER STRETCH NEW COLOR 2024

## SWIM CAP



Cap made with a super stretch fabric, lightweight, dries quickly and offers UV protection. The fabric is comfortable for long hair without pulling or snagging. The elastic band at the base ensures a tight fit.



CODE	COLOR
USW040000B	BLUE
USW040000K	BLACK
USW040000P	PINK
<span style="background-color: yellow;">NEW</span> XDF240010	YELLOW
<span style="background-color: yellow;">NEW</span> XDF240080	RED
<span style="background-color: yellow;">NEW</span> XDF240090	GREEN

# SWIFT NEW 2024

## SILICONE SWIM CAP



NAVY/BLUE



WHITE/BLACK



WHITE/AQUA GREEN



WHITE/PINK

CODE	STYLE	COLOR
ZDF232420	ADULT	NAVY/BLUE
ZDF233050	ADULT	WHITE/BLACK
ZDF233063	ADULT	WHITE/AQUA GREEN
ZDF233040	ADULT	WHITE/PINK
ZDF252420	DREADLOCKS	NAVY/BLUE
ZDF253063	DREADLOCKS	WHITE/AQUA GREEN





**CRESSI HYDROSPORTS**  
**2024 COLLECTION**

Today, with this new line of products, Cressi seeks to bring its passion above the surface and to the horizon. The Hydrosports line brings together our new iSUP & iKAYAK collection. These assortments reflect not only the hard work and dedication of our designers and engineers to create innovative new products, but also highlights Cressi's proud history of making products – most of them manufactured in our facility in Italy – which remain in the market for decades, thanks to our commitment to safety, performance, and reliability. With the company's close relationship to this environment, the Cressi team has been able to develop this new line in response to the direct needs it encountered in practice and through water tests on its products.

Cressi's Hydrosports line mirrors people who share the same passion as us, discovering the world beyond the horizon.

**START EXPLORING**  
**WITH CRESSI HYDROSPORTS.**

**CRESSI**





**iSUP**

A photograph of two women on a surfboard in the ocean. The woman in the foreground is smiling and looking towards the camera, with water splashing around her. The woman in the background is partially visible, also on the surfboard. The scene is bright and sunny, with a clear blue sky and ocean.

**START  
EXPLORING  
THE  
HORIZON**



# ISUP CATALOG A COMPARING TOOL

The Cressi catalog is designed to describe as best as possible each board's features, such as materials, construction, ability scores and box/set contents.

This catalog collects all the information to let you find the best suitable products to your need to have the best experiences on water.

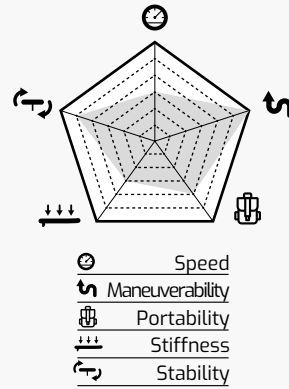

### Abilities chart

On this graph you can quickly see the ability scores of each Cressi Hydrosports SUP boards.



### Case packaging

Case packaging picture and box content list

### Human size comparison

Thanks to this visualization, you can immediately see the size of the SUP, compared to a human figure of 180 cm · 6 ft in height.



### Comparison table

At the end of the ISUP section you can find the comparison table between all the tables in the catalog. On this double page you can have an overview of the entire Cressi ISUP collection.



# THE SHAPES OF THE COLLECTION

The shapes of the SUP are designed to combine aesthetics and functionality.

**All Round:** easy to handle and stable, ideal for all levels of experience and sea conditions.

**Touring:** highly hydrodynamic, it is suitable for the more experienced and for long paddling sessions.

**Fish:** very stable and voluminous, it is suitable as a base for alternative activities.



	ALL ROUND	TOURING	FISH
Stability	++++	+++	+++++
Maneuverability	+++++	+++	++++
Hydrodynamics	+++	+++++	++

# FIND YOUR BOARD COMPATIBILITY CHART

This matrix is intended to help you find your SUP board according to your body measures and skill level.

Find the boards list in the cell between the cross section of row and column.

	BEGINNER	INTERMEDIATE	EXPERIENCED
<b>Weight:</b> 40 - 55 kg 88 - 121 lb	Element 8'2" Element 9'2" Travelight 9'2" Reef 10'2" Tiger Shark 10'2" Fluid 10'2"	Element 8'2" Element 9'2" Travelight 9'2" Reef 10'2" Tiger Shark 10'2" Fluid 10'2" Jet 11'2"	Travelight 9'2" Reef 10'2" Tiger Shark 10'2" Fluid 10'2" Jet 11'2" Fury 12'2"
<b>Weight:</b> 55 - 70 kg 121 - 154 lb	Element 9'2" Element 10'2" Reef 10'2" Tiger Shark 10'2" Fluid 10'2" Solid 10'6"	Element 9'2" Element 10'2" Travelight 9'2" Reef 10'2" Tiger Shark 10'2" Fluid 10'2" Jet 11'2" Solid 10'6"	Travelight 9'2" Reef 10'2" Tiger Shark 10'2" Fluid 10'2" Jet 11'2" Fury 12'2" Solid 10'6"
<b>Weight:</b> 70 - 85 kg 154 - 187 lb	Element 10'2" Reef 10'2" Tiger Shark 10'2" Fluid 10'2" Solid 10'6"	Element 9'2" Element 10'2" Travelight 9'2" Reef 10'2" Tiger Shark 10'2" Fluid 10'2" Jet 11'2" Solid 10'6"	Travelight 9'2" Reef 10'2" Tiger Shark 10'2" Fluid 10'2" Jet 11'2" Fury 12'2" Solid 10'6"
<b>Weight:</b> 85 - 100 kg 187 - 220 lb	Element 10'2" Reef 10'2" Tiger Shark 10'2" Fluid 10'2" Solid 10'6"	Element 10'2" Reef 10'2" Tiger Shark 10'2" Fluid 10'2" Jet 11'2" Solid 10'6"	Travelight 9'2" Reef 10'2" Tiger Shark 10'2" Fluid 10'2" Jet 11'2" Fury 12'2" Solid 10'6"
<b>Weight:</b> >100 kg >220 lb	Element 10'2" Reef 10'2" Tiger Shark 10'2" Fluid 10'2" Solid 10'6"	Element 10'2" Reef 10'2" Tiger Shark 10'2" Fluid 10'2" Solid 10'6"	Reef 10'2" Tiger Shark 10'2" Fluid 10'2" Fury 12'2" Solid 10'6"
<b>Tandem:</b> Max 160 kg 353 lb		Solid 12'2"	Solid 12'2"

# ELEMENT

## ALL ROUND ISUP SET



### ELEMENT SMALL 8'2"

Length	250 cm	8'2"
Width	71 cm	28"
Thickness	15 cm	6"
Volume	210 l	
Max press.	15 PSI	1 BAR
Inflation	5 minutes	
Max load	80 kg	176 lb
Board weight	7.5 kg (± 0.2)	16.5 lb
Set weight	11 kg (± 0.2)	24 lb
Technology	DWF	
N° Chambers	1	
Fin Box	Mini Quick Fin Box	
Fin	Mini Quick 7"	
Valve	HP Valve	
Box dimensions	40 x 88 x 25 cm	16 x 35 x 10 in



### ELEMENT 9'2"

Length	280 cm	9'2"
Width	76 cm	30"
Thickness	15 cm	6"
Volume	250 l	
Max press.	15 PSI	1 BAR
Inflation	6 minutes	
Max load	100 kg	220 lb
Board weight	8 kg (± 0.2)	17.5 lb
Set weight	12 kg (± 0.2)	26.5 lb
Technology	DWF	
N° Chambers	1	
Fin Box	US Fin Box	
Fin	US 8"	
Valve	HP Valve	
Box dimensions	40 x 88 x 25 cm	16 x 35 x 10 in



### ELEMENT 10'2"

Length	310 cm	10'2"
Width	81 cm	32"
Thickness	15 cm	6"
Volume	300 l	
Max press.	15 PSI	1 BAR
Inflation	8 minutes	
Max load	120 kg	264 lb
Board weight	9 kg (± 0.2)	20 lb
Set weight	13 kg (± 0.2)	28.5 lb
Technology	DWF	
N° Chambers	1	
Fin Box	US Fin Box	
Fin	US 8"	
Valve	HP Valve	
Box dimensions	40x88x26 cm	16 x 35 x 10 in

Minimalism and pure lines, combined with the quality of Cressi DWF technology, give rise to a classic, no-frills inflatable SUP for paddling purists.

The All Round shape, with rounded nose and flat tail, provides great maneuverability and stability. The nose rocker (curved bow) improves buoyancy by preventing the tip of the board from plunging into choppy waters, making Element perfect for sea use.

The large diamond-patterned pad offers a spacious walkable area and optimal grip, even when barefoot in the water. Element is a ready-to-use set, easy to inflate (in under 10 minutes), carry and store thanks to the practical backcase pack supplied: a space-saving solution equipped with all the accessories you need to go stand-up paddleboarding with peace of mind. Available in different sizes, it's suitable for all levels of experience and build.

### TECHNICAL FEATURES

#### · ELEMENT SMALL 8'2" SET INCLUDES:

- Element ISUP 8'2" (x1)
- MOD3 Paddle (x1)
- Mini Quick Skeg Fin 7" (x1)
- Coiled Leash 10' (x1)
- EXA 120L Backcase pack (x1)
- Welter Pump(x1)
- Repair Kit (x1)
- User Manual (x1)

#### · ELEMENT SMALL 9'2" SET INCLUDES:

- Element ISUP 9'2" (x1)
- MOD3 Paddle (x1)
- US Skeg Fin 8" (x1)
- Coiled Leash 10' (x1)
- EXA 120L Backcase pack (x1)
- Welter Pump(x1)
- Repair Kit (x1)
- User Manual (x1)

#### · ELEMENT SMALL 10'2" SET INCLUDES:

- Element ISUP 10'2" (x1)
- MOD3 Paddle (x1)
- US Skeg Fin 8" (x1)
- Coiled Leash 10' (x1)
- EXA 120L Backcase pack (x1)
- Welter Pump(x1)
- Repair Kit (x1)
- User Manual (x1)

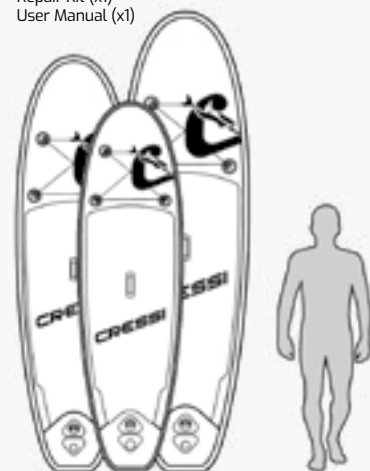

CODE	COLOR	CASE PACK	SIZE
NA000832	WHITE/AQUAMARINE	1	8'2"
NA000934	WHITE/PINK	1	9'2"
NA001032	WHITE/BLUE	1	10'2"



# TRAVELIGHT

FOLDABLE 9'2" ISUP SET



Easy to transport, light and compact: Travelight is the Cressi Hydrosports SUP that's ideal for travelers. The special pad design of the SUP enables it to be folded longitudinally then rolled up, thereby occupying half the space of an inflatable SUP of the same size. Travelight is made with Cressi LWF technology, our lightest and strongest construction in the Inflatable category, which minimizes its weight without affecting performance.

The All Round shape makes the board highly versatile and manageable for different levels of experience and build.

The set is complemented by similarly compact accessories designed ad hoc, including the small Feather pump and the MOD5 modular paddle, which lets you transport the entire set in the TERA backcase pack, only 50 cm tall.

## TECHNICAL FEATURES

### TRAVELIGHT ISUP 9'2" SET INCLUDES:

- Travelight ISUP 9'2" (x1)
- MOD5 Paddle (x1)
- Mini Quick Skeg Fin 7" (x2)
- Coiled Leash 10' (x1)
- TERA 60L Backcase pack (x1)
- Feather Pump(x1)
- Repair Kit (x1)
- User Manual (x1)

<b>Length</b>	280 cm
<b>Width</b>	81 cm
<b>Thickness</b>	15 cm
<b>Volume</b>	280 l
<b>Max press.</b>	15 PSI
<b>Inflation</b>	13 minutes
<b>Max load</b>	110 kg
<b>Board weight</b>	8 kg (± 0,2)
<b>Set weight</b>	11 kg (± 0,2)
<b>Technology</b>	LWF
<b>N° Chambers</b>	1
<b>Fin Box</b>	Mini Quick Fin Box(x2)
<b>Fin</b>	Mini Quick 7" (x2)
<b>Valve</b>	HP Valve
<b>Box dimensions</b>	40x53x26 cm

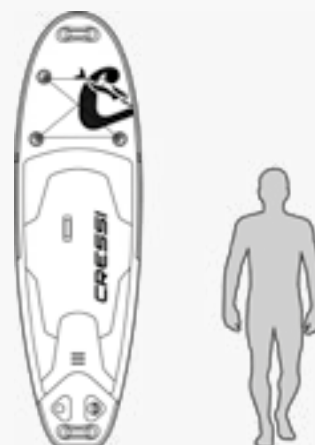

CODE	COLOR	CASE PACK	SIZE
NA010980	White/Blue	1	9'2"

# REEF

## WINDOW 10'2" ISUP SET

The full snorkeling experience from above the surface: a new perspective for encountering and observing the underwater environment with maximum respect. This is Reef, the new Cressi Window ISUP with the biggest window yet.

The large 34" 'fish' shape coupled with the pre-laminated material have enabled us to design an elongated window that extends from the paddling

position to the bow, and thanks to the sturdy layer of Crystal Clear PVC, Reef's window offers an exceptional view of the seabed during your outing.

The high buoyancy, curved bow and generous 9" drift give the board great stability, to let you comfortably admire the sea wherever you go.



### TECHNICAL FEATURES

- Reef ISUP 10'2" set includes:  
 Reef ISUP 10'2" (x1)  
 MOD3 Paddle (x1)  
 US Skeg Fin 9" (x1)  
 Coiled Leash 10' (x1)  
 EXA 120L Backcase pack (x1)  
 Welter Pump (x1)  
 Repair Kit (x1)  
 User Manual (x1)

Length	310 cm	10'2"
Width	86 cm	34"
Thickness	15 cm	6"
Volume	290 l	
Max press.	15 PSI	1 BAR
Inflation	7 minutes	
Max load	110 kg	242 lb
Board weight	10 kg (± 0.2)	22 lb
Set weight	14 kg (± 0.2)	31 lb
Technology	WPLF	
N° Chambers	1	
Fin Box	US Fin Box	
Fin	US 9"	
Valve	HP Valve	
Box dimensions	40x93x28 cm	

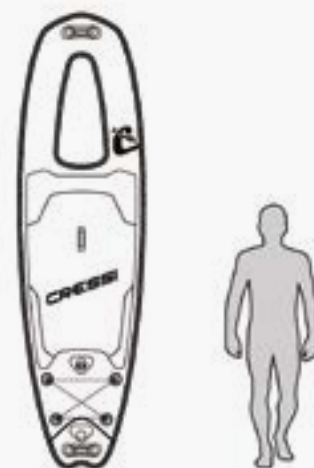

CODE	COLOR	CASE PACK	SIZE
NA031020	Blue	1	10'2"

# FLUID

## ALL ROUND 10'2" ISUP SET

Our most versatile, safe and performing board in all aquatic conditions and activities, suitable for learners as well as the most experienced, ideal for sea excursions in calm or choppy waters, through to yoga and fitness.

Thanks to Cressi Double Chamber PLF technology, this inflatable board also combines exceptional structural stiffness with the safety of a second integrated air chamber.

Stable and maneuverable thanks to its generous thickness (15 cm) and wide width (81 cm), Fluid is

the ideal SUP to ensure maximum fun at all times. Equipped with an 8" fin to increase maneuverability, the classic All Round shape with a rounded and curved bow transmits a linear and gentle feeling of paddling.

The diamond-patterned pad always ensures a firm grip, even with bare feet in wet conditions.

Fluid is a set complete with all the accessories you need to practice, and thanks to the supplied pump it inflates in under 10 minutes.



### TECHNICAL FEATURES

#### · FLUID ISUP 10'2" SET INCLUDES:

Fluid ISUP 10'2" (x1)  
MOD3 Paddle(x1)  
US Skeg Fin 8" (x1)  
Coiled Leash 10' (x1)  
EXA 120L Backcase pack (x1)  
Welter Pump (x1)  
Repair Kit (x1)  
User Manual (x1)

Length	310 cm	10'2"
Width	81 cm	32"
Thickness	15 cm	6"
Volume	300 l	
Max press.	15 PSI	1 BAR
Inflation	8 minutes	
Max load	120 kg	264 lb
Board weight	10 kg (± 0,2)	22 lb
Set weight	14 kg (± 0,2)	31 lb
Technology	DC PLF	
N° Chambers	2	
Fin Box	US Fin Box	
Fin	US 8"	
Valve	HP Valve (x2)	
Box dimensions	40x88x28 cm	

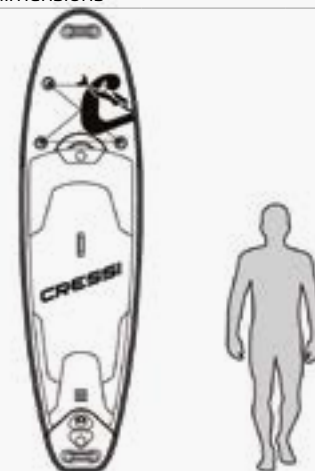

CODE	COLOR	CASE PACK	SIZE
NA021020	Blue	1	10'2"



# TIGER SHARK

## MULTITASK 10'2" ISUP SET

Can the pleasure of stand-up paddleboarding be combined with a passion for spearfishing and freediving? Tiger Shark was born from this question and is designed to offer new possibilities for enjoying these activities.

The large and spacious 'fish' shape is ideal for providing stability onboard when preparing and setting up the equipment.

Thanks to Cressi Storage Hatch PLF technology, this board makes it easy to transport equipment, with a large and practical locker in the bow equipped with a cover mesh pocket for storing items like ropes, fins or the catch itself.

The supplied adjustable strap with D-Ring can be passed under the board to connect the ascent line during diving and stored while paddling, so as not to affect hydrodynamic performance.

The bow is equipped with a base and shaft with a diving flag, while the D-Rings are equipped with adjustable elastic bands to attach spearguns and rods to the side hooks, so as not to take up space onboard and always offer a view of the equipment. The practical bungee elastic cords are positioned at the stern to provide an additional cargo area.



### TECHNICAL FEATURES

**TIGER SHARK ISUP 10'2" SET INCLUDES:**

- Tigershark ISUP 10'2" (x1)
- MOD3 Paddle (x1)
- US Skieg Fin 9" (x1)
- Coiled Leash 10' (x1)
- EXA 120l Backcase pack (x1)
- Welter Pump (x1)
- Diver down Flag (x1)
- Repair Kit (x1)
- User Manual (x1)

Length	310 cm	10'2"
Width	86 cm	34"
Thickness	15 cm	6"
Volume	320 l	
Max press.	15 PSI	1 BAR
Inflation	8 minutes	
Max load	130 kg	286 lb
Board weight	10 kg (± 0,2)	22 lb
Set weight	14 kg (± 0,2)	31 lb
Technology	SH PLF	
N° Chambers	1	
Fin Box	US Fin Box	
Fin	US 9"	
Valve	HP Valve	
Box dimensions	40x93x28 cm	



CODE	COLOR	CASE PACK	SIZE
NA041025	Camo Aqua	1	10'2"

# FURY

## TOURING 12'2" ISUP SET

Fury is the ISUP from Cressi Hydrosports dedicated to touring. The hydrodynamic and elongated shape, coupled with the very light Carbon paddle supplied, make this set the best one for lengthy paddleboarding sessions.

The curved bow (nose rocker) improves its buoyancy in the sea, preventing the tip from sinking into the ripples of the waves, while creating hydrodynamic resistance.

The Cressi Double Chamber PLF technology maintains a highly performing structural stiffness while paddling, despite the board's length of over 12 feet, and the double air chamber guarantees greater safety in case of accidental punctures.

The large 9" drift positioned far from the center of gravity helps maintain a linear trajectory even at low speeds, providing an advantage over long distances.



### TECHNICAL FEATURES

#### · FURY ISUP 12'2" SET INCLUDES:

Fury ISUP 12'2" (x1)  
Carbon Paddle (x1)  
US Skeg Fin 9" (x1)  
Coiled Leash 10' (x1)  
EXA 120L Backcase pack (x1)  
Welter Pump (x1)  
Repair Kit (x1)  
User Manual (x1)

Length	371 cm	12'2"
Width	76 cm	30"
Thickness	15 cm	6"
Volume	300 l	
Max press.	15 PSI	1 BAR
Inflation	8 minutes	
Max load	120 kg	264 lb
Board weight	10,5 kg (± 0,2)	23 lb
Set weight	14,5 kg (± 0,2)	32 lb
Technology	DC PLF	
N° Chambers	2	
Fin Box	US Fin Box	
Fin	US 9"	
Valve	HP Valve (x2)	
Box dimensions	40x88x30 cm	



CODE	COLOR	CASE PACK	SIZE
NA051280	Red	1	12'2"

# SOLID

## RENTAL ISUP

Solid is the Cressi Hydrosports SUP family designed specifically for professional rental. The use of Double Chamber Reinforced PLF technology and triple-layer anti-abrasion rail (the most resistant and robust composition in the whole collection) guarantee maximum structural rigidity and great safety during sessions at sea.

The board is available in the All Round version with one seat and Tandem with two seats.

Due to their intended professional use, the two versions of Solid have features designed to improve the experience of both the boards' end users and those who rent them.

Numerous D-rings and handles are positioned along Solid's structure to facilitate hooking and transport. Furthermore, each side features special dedicated HIN (Hull Identification Number) spaces for customized numbering by the rental center.

The US Click fins supplied have a quick coupling and release system, with a variable-intensity locking system.

Each board will be accompanied by a Trailer Leash, a reinforced elastic rope with double S-shape carabiner, useful for towing and mooring.

SOLID IS EQUIPPED WITH US QUICK SKEG FIN 9" WITH FAST LOCKING SYSTEM:



SOLID HAS 5 PRACTICAL HANDLES TO FACILITATE TRANSPORT AND STORAGE:



x2

### ALL ROUND 10'6"

Length	323 cm	10'6"
Width	81 cm	32"
Thickness	15 cm	6"
Volume	310 l	
Max press.	15 PSI	1 BAR
Inflation	8 minutes	
Max load	125 kg	275 lb
Board weight	10,5 kg (± 0,2)	23 lb
Set weight	11,3 kg (± 0,2)	25 lb
Technology	DC PLF reinforced	
N° Chambers	2	
Fin Box	US Fin Box	
Fin	US Quick 9"	
Valve	HP Valve (x2)	
Box dimensions	40x88x18 cm	

### TANDEM 12'2"

Length	371 cm	12'2"
Width	86 cm	34"
Thickness	15 cm	6"
Volume	400 l	
Max press.	15 PSI	1 BAR
Inflation	10 minutes	
Max load	160 kg	352 lb
Board weight	13 kg (± 0,2)	28 lb
Set weight	14,5 kg (± 0,2)	32 lb
Technology	DC PLF reinforced	
N° Chambers	2	
Fin Box	US Fin Box (x2)	
Fin	US Quick 9" (x2)	
Valve	HP Valve (x2)	
Box dimensions	40x93x18 cm	

CODE	COLOR	CASE PACK	SIZE
NB011070	Grey/Fluo	1	10'6"
NB001270	Grey/Fluo	1	12'2"





# DESIGNED FOR PROFESSIONAL RENTAL ACTIVITIES



Thanks to the Trailer Leash supplied, it will be possible to easily and quickly connect the boards through the D-Rings positioned at the bow and stern, so as to be able to keep all the boards under control during each tours.



## TECHNICAL FEATURES

• **SOLID 10'6" SET INCLUDES:**

- Solid ISUP 12'2" (x1)
- U5 Quick Skeg Fin 9" (x1)
- Trailer Leash 8' (x1)

• **SOLID 12'2" SET INCLUDES:**

- Solid ISUP 12'2" (x1)
- U5 Quick Skeg Fin 9" (x2)
- Trailer Leash 8' (x1)



# ISUP BOARDS

## COMPARISON CHART



Board	<b>ELEMENT SMALL 8'2"</b>		<b>ELEMENT 9'2"</b>		<b>ELEMENT 10'2"</b>		<b>TRAVELIGHT 9'2"</b>		<b>REEF 10'2"</b>	
Code	NA000832		NA000934		NA001032		NA010980		NA031020	
Category	All Round ISUP		All Round ISUP		All Round ISUP		Foldable ISUP		Window ISUP	
Length	250 cm	8'2"	280 cm	9'2"	310 cm	10'2"	280 cm	9'2"	310 cm	10'2"
Width	71 cm	28"	76 cm	30"	81 cm	32"	81 cm	32"	86 cm	34"
Thickness	15 cm	6"	15 cm	6"	15 cm	6"	15 cm	6"	15 cm	6"
Volume	210 l		250 l		300 l		280 l		290 l	
Max press.	15 PSI	1 BAR	15 PSI	1 BAR	15 PSI	1 BAR	15 PSI	1 BAR	15 PSI	1 BAR
Inflation	5 minutes		6 minutes		8 minutes		13 minutes		7 minutes	
Max load	80 kg	176 lbs	100 kg	220 lbs	120 kg	264 lbs	110 kg	242 lbs	110 kg	242 lbs
Board weight	7.5 kg (± 0.2)	16.5 lbs	8 kg (± 0.2)	17.5 lbs	9 kg (± 0.2)	20 lbs	8 kg (± 0.2)	17.5 lbs	10 kg (± 0.2)	22 lbs
Set weight	11 kg (± 0.2)	24 lbs	12 kg (± 0.2)	26.5 lbs	13 kg (± 0.2)	28.5 lbs	11 kg (± 0.2)	24 lbs	14 kg (± 0.2)	31 lbs
Technology	DWF		DWF		DWF		LWF		WPLF	
N° Chambers	1		1		1		1		1	
Fin Box	Mini Quick Fin Box		US Fin Box		US Fin Box		Mini Quick Fin Box (x2)		US Fin Box	
Fin	Mini Quick 7"		US 8"		US 8"		Mini Quick 7" (x2)		US 9"	
Valve	HP Valve		HP Valve		HP Valve		HP Valve		HP Valve	
The set includes	<ul style="list-style-type: none"> <li>· Element ISUP 8'2" (x1)</li> <li>· MOD3 Paddle (x1)</li> <li>· Mini Quick Skeg Fin 7" (x1)</li> <li>· Coiled Leash 10' (x1)</li> <li>· EXA 120L Backcase pack (x1)</li> <li>· Welter Pump (x1)</li> <li>· Repair Kit (x1)</li> <li>· User Manual (x1)</li> <li>· Element ISUP 9'2" (x1)</li> </ul>		<ul style="list-style-type: none"> <li>· MOD3 Paddle (x1)</li> <li>· US Skeg Fin 8" (x1)</li> <li>· Coiled Leash 10' (x1)</li> <li>· EXA 120L Backcase pack (x1)</li> <li>· Welter Pump (x1)</li> <li>· Repair Kit (x1)</li> <li>· User Manual (x1)</li> <li>· Element ISUP 10'2" (x1)</li> <li>· MOD3 Paddle (x1)</li> <li>· US Skeg Fin 8" (x1)</li> </ul>		<ul style="list-style-type: none"> <li>· Coiled Leash 10' (x1)</li> <li>· Travelight ISUP 9'2" (x1)</li> <li>· MOD5 Paddle (x1)</li> <li>· Mini Quick Skeg Fin 7" (x2)</li> <li>· Coiled Leash 10' (x1)</li> </ul>		<ul style="list-style-type: none"> <li>· TERA 60L backcase pack (x1)</li> <li>· Feather Pump (x1)</li> <li>· Repair Kit (x1)</li> <li>· User Manual (x1)</li> <li>· EXA 120L Backcase pack (x1)</li> <li>· Welter Pump (x1)</li> <li>· Repair Kit (x1)</li> <li>· User Manual (x1)</li> <li>· Reef ISUP 10'2" (x1)</li> <li>· MOD3 Paddle (x1)</li> <li>· US Skeg Fin 9" (x1)</li> <li>· Coiled Leash 10' (x1)</li> <li>· EXA 120L Backcase pack (x1)</li> <li>· Welter Pump (x1)</li> </ul>		<ul style="list-style-type: none"> <li>· Repair Kit (x1)</li> <li>· User Manual (x1)</li> </ul>	
Features	All Round ISUP for all sea conditions and activities, suitable for beginners from 40-50 kg to intermediate 50-60 kg		All Round ISUP for all sea conditions and activities, suitable for beginners from 50-70 kg to intermediate 70-80 kg		All Round ISUP for all sea conditions and activities, suitable for beginners from 60-90 kg to intermediate > 90 kg		Super compact and lightweight All Round ISUP, perfect for travel and for those who have space requirements.		ISUP with window to observe the seabed during paddling, stable and voluminous.	



IDEAL FOR RENTAL

IDEAL FOR RENTAL

**FLUID 10'2"**

NA021020

All Round ISUP

310 cm	10'2"
81 cm	32"
15 cm	6"
300 l	
15 PSI	1 BAR
8 minutes	
120 kg	264 lbs
10 kg (± 0.2)	22 lbs
14 kg (± 0.2)	31 lbs
DC PLF	
2	
US Fin Box	
US 8"	
HP Valve (x2)	

- Fluid ISUP 10'2" (x1)
- MOD3 Paddle (x1)
- US Skeg Fin 8" (x1)
- Coiled Leash 10' (x1)
- EXA 120L Backcase pack (x1)
- Welter Pump (x1)
- Repair Kit (x1)
- User Manual (x1)

All Round ISUP for all sea conditions and activities, made with double chamber for maximum stiffness and safety.

**TIGER SHARK 10'2"**

NA041025

Multitask ISUP

310 cm	10'2"
86 cm	34"
15 cm	6"
320 l	
15 PSI	1 BAR
8 minutes	
130 kg	286 lbs
10 kg (± 0.2)	22 lbs
14 kg (± 0.2)	31 lbs
SH PLF	
1	
US Fin Box	
US 9"	
HP Valve	

- Tigershark ISUP 10'2" (x1)
- MOD3 Paddle (x1)
- US Skeg Fin 9" (x1)
- Coiled Leash 10' (x1)
- EXA 120L Backcase pack (x1)
- Welter Pump (x1)
- Diver down Flag (x1)
- Repair Kit (x1)
- User Manual (x1)
- Fury ISUP 12'2" (x1)

ISUP with integrated locker, and laces for carrying equipment, the ideal board for spearfishing and freediving.

**FURY 12'2"**

NA051280

Touring ISUP

371 cm	12'2"
76 cm	30"
15 cm	6"
300 l	
15 PSI	1 BAR
8 minutes	
120 kg	264 lbs
10.5 kg (± 0.2)	23 lbs
14.5 kg (± 0.2)	32 lbs
DC PLF	
2	
US Fin Box	
US 9"	
HP Valve (x2)	

- Carbon paddle (x1)
- US Skeg Fin 9" (x1)
- Coiled Leash 10' (x1)
- EXA 120L Backcase pack (x1)
- Welter Pump (x1)
- Repair Kit (x1)
- User Manual (x1)
- Solid ISUP 10'6" (x1)
- US Quick Skeg Fin 9" (x1)

Touring ISUP for long time sea tours, made with double chamber for maximum stiffness and safety.

**SOLID 10'6"**

NB011070

All Round ISUP

323 cm	10'6"
81 cm	32"
15 cm	6"
310 l	
15 PSI	1 BAR
8 minutes	
125 kg	275 lbs
10.5 kg (± 0.2)	23 lbs
11.5 kg (± 0.2)	25 lbs
DC PLF reinforced	
2	
US Fin Box	
US Quick 9"	
HP Valve (x2)	

- Trailer Leash 8' (x1)
- Solid ISUP 12'2" (x1)
- US Quick Skeg Fin 9" (x2)
- Trailer Leash 8' (x1)

All Round ISUP designed for rental activities, made with reinforced construction; great marine safety and product durability.

**SOLID 12'2"**

NB001270

Tandem ISUP

371 cm	12'2"
86 cm	34"
15 cm	6"
400 l	
15 PSI	1 BAR
10 minutes	
160 kg	352 lbs
13 kg (± 0.2)	28 lbs
14.5 kg (± 0.2)	32 lbs
DC PLF reinforced	
2	
US Fin Box (x2)	
US Quick 9" (x2)	
H P Valve (x2)	

Tandem ISUP (double seat) designed for rental activities; reinforced construction to improve safety and product durability.





# PADDLES

## ISUP & KAYAK

Lightness, strength and versatility: these are the key values our collection of paddles seeks to offer. Our designs are created to meet the specific needs of those who go stand-up paddleboarding and kayaking, with a focus on inflatable products and portability.

For this reason, the choice of materials is directed only towards those with high levels of corrosion resistance, lightness, and elasticity such as aluminum, nylon and carbon fiber.

Behind the apparent simplicity hides great attention to detail, aimed at improving performance and usability.

Highlights include: the one-hand height adjustment mechanism, the floating capacity and an easy assembly system.

Finally, modularity is what unites all our paddles, to ensure easy transport and storage within the sets they are supplied in.

## SHAFT LOCKING LEVER



**DESCRIPTION:**  
Paddle shaft locking lever with stainless steel bolt and self-locking nut.

**SUITABLE FOR:**  
MOD3 SUP Paddle  
MOD5 SUP Paddle  
Carbon SUP Paddle

CODE

NZ000700



## MOD3 SUP PADDLE

Max Height	215 cm	84"
Min Height	165 cm	64"
Disassembled	89 cm	35"
N° of modules	3	
Materials	Aluminum and Nylon	
Blade dimensions	47x18 cm	18"x7"
Paddle Weight	990 g	
Box dimensions	20x6x90 cm	

**DESCRIPTION:**  
Sturdy and versatile telescopic SUP paddle in 3 modules, suitable for all levels of experience. Floating and adjustable with centering and height notches, one-hand locking system. Aluminum handle and stainless button springs, reinforced nylon blade and handle.

**SUITABLE FOR:**  
All Cressi Hydrosports ISUP boards.



CODE

NM035020

## MOD5 SUP PADDLE

Max Height	218 cm	86"
Min Height	185 cm	73"
Disassembled	50 cm	19"
N° of modules	5	
Materials	Aluminum and Nylon	
Blade dimensions	42x20 cm	16"x8"
Paddle Weight	1100 g	
Box dimensions	22x8x52 cm	

**DESCRIPTION:**  
Telescopic SUP paddle in 5 modules, designed for those who need to transport it in compact backcase packs. Floating and adjustable with centering and height notches, one-hand locking system. Aluminum handle and stainless button springs, reinforced nylon blade and handle.

**SUITABLE FOR:**  
All Cressi Hydrosports ISUP boards.



CODE

NM055020

## CARBON SUP PADDLE

Max Height	215 cm	84"
Min Height	165 cm	64"
Disassembled	90 cm	35"
N° of modules	3	
Materials	Carbon fiber	
Blade dimensions	48x18 cm	19"x7"
Paddle Weight	650 g	
Box dimensions	22x8x90 cm	

**DESCRIPTION:**  
High-performance and lightweight SUP paddle, suitable for long sessions and distances. Floating and adjustable with centering and height notches, one-hand locking system. Carbon fiber handle and blade.

**SUITABLE FOR:**  
All Cressi Hydrosports ISUP boards.



CODE

NM075050

# SKEG FINS

iSUP & KAYAK



## US SKEG FIN 8"

Maneuverability	•••••
Roll Stability	•••••
Draft	205 mm 8"
Material	ABS
Fin Box	US Fin Box
Locking system	Threaded Pin
Box dimensions	26,5x2x24 cm

**DESCRIPTION:**

8" (20 cm) keel fin for SUP and longboard made of sturdy ABS plastic feature a threaded pin for tool-less closure. Ideal for all-round boards, for a better balance between maneuverability and stability.

**SUITABLE FOR:**

Element All Round 9'2" ISUP  
 Element All Round 10'2" ISUP  
 Reef Window 10'2" ISUP  
 Fluid All Round 10'2" ISUP  
 Jet Cruise ISUP 11'2"  
 Tiger Shark Multitask 10'2" ISUP  
 Fury Touring 12'2" ISUP  
 Solid All Round 10'6" ISUP  
 Solid Tandem 12'2" ISUP

**SPARE PARTS:**

US Skeg Fin Screw

## US SKEG FIN 9"

Maneuverability	•••••
Roll Stability	•••••
Draft	230 mm 9"
Material	Nylon
Fin Box	US Fin Box
Locking system	Threaded Pin
Box dimensions	30x2x28 cm

**DESCRIPTION:**

9" (23 cm) keel fin for SUP and longboard made of elastic Nylon plastic feature a threaded pin for tool-less closure. Ideal for touring and race boards to keep straight trajectories and high stability.

**SUITABLE FOR:**

Element All Round 9'2" ISUP  
 Element All Round 10'2" ISUP  
 Reef Window 10'2" ISUP  
 Fluid All Round 10'2" ISUP  
 Jet Cruise ISUP 11'2"  
 Tiger Shark Multitask 10'2" ISUP  
 Fury Touring 12'2" ISUP  
 Solid All Round 10'6" ISUP  
 Solid Tandem 12'2" ISUP

**SPARE PARTS:**

US Skeg Fin Screw

## US QUICK SKEG FIN 9"

Maneuverability	•••••
Roll Stability	•••••
Draft	230 mm 9"
Material	Nylon + TPU (Pads)
Fin Box	US Fin Box
Locking system	Pads
Box dimensions	26,5x2x24,5 cm

**DESCRIPTION:**

9" (23 cm) keel fin for SUP and longboard made of elastic Nylon plastic feature the US QUICK system to adjust the intensity of the coupling according to the number of pads placed in the apposite housings. Ideal for rental boards for a faster in-water entrance and warehouse storage.

**SUITABLE FOR:**

Element All Round 9'2" ISUP  
 Element All Round 10'2" ISUP  
 Reef Window 10'2" ISUP  
 Fluid All Round 10'2" ISUP  
 Jet Cruise 11'2" ISUP  
 Tiger Shark Multitask 10'2" ISUP  
 Fury Touring 12'2" ISUP  
 Solid All Round 10'6" ISUP  
 Solid Tandem 12'2" ISUP

**SPARE PARTS:**

US Quick Skeg Fin Fixing Pads



CODE

N0000008



CODE

N0000009



CODE

N0000109

## MINI QUICK SKEG FIN 7"



**DESCRIPTION:**

7" (18 cm) keel fin for SUP and longboard made of semi-rigid TPU plastic, feature tool-less MINI QUICK coupling / release system. Ideal for compact boards with twin-fin configuration for maximum maneuverability.

**SUITABLE FOR:**

Element Small All Round 8'2" ISUP  
 Travelight Foldable 9'2" ISUP



Maneuverability	•••••
Roll Stability	•••••
Draft	178 mm 7"
Material	TPU
Fin Box	Mini Quick Fin Box
Locking system	Click
Box dimensions	26x2x19 cm

CODE

N0000207



# COILED 10'

## ISUP ANKLE LEASH



GREY/RED

Extendable coil ankle leash (max 10') which won't get in the way while paddling. Made with TPU core and neoprene anklet with steel insert to withstand the greatest stresses. Maximum comfort and safety for stand-up paddleboarding.



GREY/BLUE

CODE	COLOR	SIZE
NP001072	Grey/Blue	10'
NP001078	Grey/Red	10'

### TECHNICAL FEATURES

Max. Length	305 cm	10'
Min. Length	100 cm	3'3"
Coil diameter	7 mm	
Ankle circumference	18-30 cm	7.2"- 12"
Box dimensions	8x30x8 cm	



**FLOATING  
PRODUCT**

# TRAILER 8'

## TOWING LEASH



Leash for towing and mooring SUP boards and Kayaks, made of elastic core coated with a sturdy polyester fabric. Its composition lets you paddle and tow without tugs.

Feature quick attachment/release system on both sides thanks to the S-shape carabiners.

CODE	COLOR	SIZE
NQ005095	Black/Red	8'

### TECHNICAL FEATURES

Max. Length	240 cm	8'
Min. Length	135 cm	4'4"
Carbiner	S-Shape (x2)	
Carbiner dimensions	9x4,5 cm	3.5"x 1.7"



# WELTER

## 2000 CC HAND PUMP



Welter is the largest capacity Cressi Hydrosports pump. With a volume of 2000 cc, it can inflate a 300 l board in under 10 minutes. The mechanical selector can be used to set the pump to double or single action, to reduce fatigue when inflating at high pressures. Equipped with a deflation function,

pressure gauge and multiple bayonet connections, it's compatible with all Cressi Hydrosports SUPs and kayaks. Its foldable pedestal and unscrewable handles make the Welter compact and easy to store in a backcase pack.

### TECHNICAL FEATURES

Height	63 cm	2'
Volume	2000 cc	2x2 L
Weight	1 kg	2.2 lb
Max. Pressure	1 Bar	15 PSI
Features	Inflating / deflating Double action selector	
Box dimensions	16x11x64 cm	



CODE	COLOR	SIZE
NR000020	Blue	2000 cc

# FEATHER

## 1100 CC HAND PUMP



Compact and lightweight, this 1100 cc pump is specially designed for anyone who needs a high-performance product to be transported in the smallest possible space. Equipped with inflation/deflation function and mechanical selector for double action (air injection by both pushing and pulling)

or single action for high pressures. Equipped with folding pedestal, unscrewable handles, pressure gauge and multiple bayonet connections, it's compatible with all Cressi Hydrosports SUPs and kayaks.

### TECHNICAL FEATURES

Height	45 cm	1'5"
Volume	1100 cc	2x1,1 L
Weight	0,8 kg	1.8 lb
Max. Pressure	1 Bar	15 PSI
Features	Inflating / deflating Double action selector	
Box dimensions	16x11x46 cm	



CODE	COLOR	SIZE
NR001011	Blue	1100 cc



**WATER**  
RESISTANT



**THERMAL**  
INSULATION

# FREEZY

WATERPROOF COOLERBAG 15 LITERS



Semi-rigid and fully waterproof cooler bag equipped with adjustable straps with carabiners on his front and back side, designed for an easy attachment at the board deck D-rings Freezy maintains the temperature of food and drinks for about 12 hours, thanks to his thick insulating layer, the exclusive watertight zip protects your food and drinks from outside contacts. Equipped with a practical front pocket, adjustable shoulder strap, padded handles and practical bungee cords on the top.

CODE	CASE PACK
NW101570	1

## TECHNICAL FEATURES

- Waterproof cooler
- 12 hours thermal insulation
- Dry zip closure
- Semi-rigid structure
- Seamless stitching technology
- Adjustable shoulder strap
- 15 L capacity
- External pocket
- Top Bungee cord area
- Snap hooks for D-Rings fastening

Box dimensions 36x36x30 cm  
14.2 x 14.2 x 11.8 in



# EQUIPMENT BACKPACKS

ISUP & IKAYAK TRANSPORT



## TERA 60 LITERS

Height	52 cm	21"
Width	40 cm	16"
Depth	27 cm	11"
Box dimensions	25x50x17 cm	

CODE
NW016050

Cressi Hydrosports backcase packs for carrying equipment are designed with only the best materials and components, to ensure durability and comfort.

Available in three different sizes to fit different sets, they feature adjustable shoulder straps with chest support straps, internal straps to secure and gather equipment, a mesh bottom for ventilation, and a practical front pocket for small parts and accessories.

The generous zip lets a full front opening, making it easy to put equipment inside.



## PENTA 90 LITERS

Height	75 cm	30"
Width	45 cm	18"
Depth	27 cm	11"
Box dimensions	25x50x17 cm	

CODE
NW009050

## TECHNICAL FEATURES

- **TERA 60 LITERS SUITABLE FOR:**  
Travlight Foldable 9'2" ISUP
- **PENTA 90 LITERS SUITABLE FOR:**  
Namaka IKAYAK 8'2" Single  
Namaka IKAYAK 10'7" Double





## US SKEG FIN BOX



**DESCRIPTION:**  
Cressi fin base with US coupling system, made of high-strength polycarbonate to bolster flexion caused by lateral currents.

**SUITABLE FOR:**  
US Skeg Fin 8" - 9"  
US Quick Skeg Fin 9"

CODE

NZ000001

## MINI QUICK SKEG FIN BOX



**DESCRIPTION:**  
Cressi fin base with Mini Quick coupling system, ultra compact, ideal for Twin Fin configuration board, no-tools or screw required.

**SUITABLE FOR:**  
Mini Quick Skeg Fin 7"

CODE

NZ000000

## US SKEG FIN SCREW



**DESCRIPTION:**  
Thumb screw with flat pin, no-tools required, suitable for Cressi US fin system. Made of stainless steel, sealing o-ring and threaded plate included.

**SUITABLE FOR:**  
US Skeg Fin 8"  
US Skeg Fin 9"

CODE

NZ000100

## US QUICK FIN LOCKING PADS



**DESCRIPTION:**  
Pads to adjust the intensity of locking friction of US QUICK fins. Add or remove pads to increase or decrease the fin attachment intensity.

**SUITABLE FOR:**  
US QUICK Skeg Fin 9"

CODE

NZ000200

## HP HIGH PRESSURE VALVE



**DESCRIPTION:**  
High pressure valve with PUSH-PUSH opening, equipped with ergonomic cap and protective mesh filter.

**SUITABLE FOR:**  
All Cressi Hydrosports ISUP boards.

CODE

NZ000303

## PUMP HOSE + NOZZLES KIT



**DESCRIPTION:** 130 cm hose + nozzles kit for Cressi hand pumps, equipped with threaded connection and multi-nozzle bayonet, ideal for ISUPs, kayaks and small inflatables.

**SUITABLE FOR:** Welter 2000 cc hand pump | Feather 1100 cc hand pump  
**Nozzles kit SUITABLE FOR:** Cressi HP Valve | Cressi RQR Valve | Cressi SQR Valve

CODE

NZ000600

## 15 PSI PRESSURE GAUGE



**DESCRIPTION:** Analog manometer for Cressi hand pumps with threaded connection, maximum pressure 15 PSI (1 BAR).

**SUITABLE FOR:** Welter 2000 cc hand pump | Feather 1100 cc hand pump

CODE

NZ000610



**BRAND SUPPORT**



**CRESSI**

## FULL FACE MASK

METAL SLATWALL DISPLAY



CODE

VAEDUKE

## MASK

ACRYLIC SLATWALL DISPLAY



CODE

VAEMASK

## SNORKEL

ACRYLIC SLATWALL DISPLAY



CODE

VAESNOR

## FLAT

ACRYLIC SLATWALL DISPLAY



CODE

VAEFLAT



## WRIST COMPUTER DISPLAY

ACRYLIC TABLE TOP DISPLAY



CODE

VAEUATT

## WRIST COMPUTER DISPLAY

METAL SLATWALL DISPLAY



CODE

VAEUMWC

## REGULATOR DISPLAY

METAL SLATWALL DISPLAY



CODE

VAEUMWR

## CONSOLE DISPLAY

METAL SLATWALL DISPLAY



CODE

VAEUMWD

## HOOK FOR WETSUITS



CODE

VAEWETSUIT

## HOOK FOR FINS



CODE

VAEFINS

## SLATWALL METAL FACEOUT



CODE

VAEWAGF

## MOBILE METAL STAND DISPLAY



CODE

VAEMOMS

## BLUE FLAG



70 x 45 cm | 27.6 x 17.7 in



30 x 20 cm | 11.8 x 7.9 in

CODE	COLOR	SIZE
VABANB05	BLUE	70 x 45 cm   27.6 x 17.7 in
VABANB06	BLUE	30 x 20 cm   11.8 x 7.9 in

## DIVE CENTER FLAG



100 x 70 cm | 39.4 x 27.6 in



70 x 45 cm | 27.6 x 17.7 in



30 x 20 cm | 11.8 x 7.9 in

CODE	COLOR	SIZE
VABANB11	WHITE	100 x 70 cm   39.4 x 27.6 in
VABANB15	WHITE	70 x 45 cm   27.6 x 17.7 in
VABANB16	WHITE	30 x 20 cm   11.8 x 7.9 in



# FEATHER

34 in | 86 cm

109 in | 277 cm

WITH POLE AND BASE

CODE  
VABANOUT



2024 - CATALOG

# STICKERS

**sticker**  
Back adhesive side

Small	10 x 9,1 cm 3.94 x 3.58 in
Regular	30 x 27 cm 11.8 x 10.6 in
Big	58,5 x 53 cm 23 x 20.8 in

CODE	SIZE
VPADE5210	SMALL
VPADE5010	REGULAR
VPADE5110	BIG

**sticker**  
Back adhesive side

Small	15 x 15,3 cm 5.9 x 6 inch
Regular	30 x 30,5 cm 11.8 x 12 inch

CODE	SIZE
VPADE5011	SMALL
VPADE5211	REGULAR

**sticker**  
Back adhesive side

Size	48 x 21,1 cm 18.9 x 8.3 inch
------	---------------------------------

CODE
VPADE5012

CRESSI

## HOODIE

85% ORGANIC COTTON | 15% POLYESTER 300 GSM



CODE	SIZE
VA945202	S
VA945203	M
VA945204	L
VA945205	XL
VA945206	2XL
VA945207	3XL

## METAL DISPLAY

40 SUNGLASSES (10+10+10+10)



CODE
XVAESUNG

# OPTICAL LENSES

## FOCUS

The Optical Lens are sold individually.  
The Focus lenses can be mounted both for left and right.

PLEASE ALSO REFER TO THE **CRESSI SPARE PARTS CATALOG** FOR FURTHER INFORMATION AND TECHNICAL DETAILS.

CODE	PRODUCT
DI240110	BIFOCAL OPTICAL LENS +1.0 (LEFT) FOR FOCUS
DI240115	BIFOCAL OPTICAL LENS +1.5 (LEFT) FOR FOCUS
DI240120	BIFOCAL OPTICAL LENS +2.0 (LEFT) FOR FOCUS
DI240125	BIFOCAL OPTICAL LENS +2.5 (LEFT) FOR FOCUS
DI240130	BIFOCAL OPTICAL LENS +3.0 (LEFT) FOR FOCUS
DI240135	BIFOCAL OPTICAL LENS +3.5 (LEFT) FOR FOCUS
DI240210	BIFOCAL OPTICAL LENS +1.0 (RIGHT) FOR FOCUS
DI240215	BIFOCAL OPTICAL LENS +1.5 (RIGHT) FOR FOCUS
DI240220	BIFOCAL OPTICAL LENS +2.0 (RIGHT) FOR FOCUS
DI240225	BIFOCAL OPTICAL LENS +2.5 (RIGHT) FOR FOCUS
DI240230	BIFOCAL OPTICAL LENS +3.0 (RIGHT) FOR FOCUS
DI240235	BIFOCAL OPTICAL LENS +3.5 (RIGHT) FOR FOCUS
DI240010	OPTICAL LENS -1.0 FOR FOCUS
DI240015	OPTICAL LENS -1.5 FOR FOCUS
DI240020	OPTICAL LENS -2.0 FOR FOCUS
DI240025	OPTICAL LENS -2.5 FOR FOCUS
DI240030	OPTICAL LENS -3.0 FOR FOCUS
DI240035	OPTICAL LENS -3.5 FOR FOCUS
DI240040	OPTICAL LENS -4.0 FOR FOCUS
DI240045	OPTICAL LENS -4.5 FOR FOCUS
DI240050	OPTICAL LENS -5.0 FOR FOCUS
DI240055	OPTICAL LENS -5.5 FOR FOCUS
DI240060	OPTICAL LENS -6.0 FOR FOCUS
DI240065	OPTICAL LENS -6.5 FOR FOCUS
DI240070	OPTICAL LENS -7.0 FOR FOCUS
DI240075	OPTICAL LENS -7.5 FOR FOCUS
DI240080	OPTICAL LENS -8.0 FOR FOCUS

## BIG EYES EVOLUTION & QUANTUM

PLEASE ALSO REFER TO THE **CRESSI SPARE PARTS CATALOG** FOR FURTHER INFORMATION AND TECHNICAL DETAILS.

CODE	PRODUCT
DI335010	BIFOCAL OPTICAL LENS +1.0 (RIGHT) FOR BIG EYES EVO/QUANTUM
DI335015	BIFOCAL OPTICAL LENS +1.5 (RIGHT) FOR BIG EYES EVO/QUANTUM
DI335020	BIFOCAL OPTICAL LENS +2.0 (RIGHT) FOR BIG EYES EVO/QUANTUM
DI335025	BIFOCAL OPTICAL LENS +2.5 (RIGHT) FOR BIG EYES EVO/QUANTUM
DI335030	BIFOCAL OPTICAL LENS +3.0 (RIGHT) FOR BIG EYES EVO/QUANTUM
DI336010	OPTICAL LENS - 1.0 (RIGHT) FOR BIG EYES EVO/QUANTUM
DI336015	OPTICAL LENS - 1.5 (RIGHT) FOR BIG EYES EVO/QUANTUM
DI336020	OPTICAL LENS - 2.0 (RIGHT) FOR BIG EYES EVO/QUANTUM
DI336025	OPTICAL LENS - 2.5 (RIGHT) FOR BIG EYES EVO/QUANTUM
DI336030	OPTICAL LENS - 3.0 (RIGHT) FOR BIG EYES EVO/QUANTUM
DI336035	OPTICAL LENS - 3.5 (RIGHT) FOR BIG EYES EVO/QUANTUM
DI336040	OPTICAL LENS - 4.0 (RIGHT) FOR BIG EYES EVO/QUANTUM
DI336045	OPTICAL LENS - 4.5 (RIGHT) FOR BIG EYES EVO/QUANTUM
DI336050	OPTICAL LENS - 5.0 (RIGHT) FOR BIG EYES EVO/QUANTUM
DI336055	OPTICAL LENS - 5.5 (RIGHT) FOR BIG EYES EVO/QUANTUM
DI336060	OPTICAL LENS - 6.0 (RIGHT) FOR BIG EYES EVO/QUANTUM
DI335110	BIFOCAL OPTICAL LENS +1.0 (LEFT) FOR BIG EYES EVO/QUANTUM
DI335115	BIFOCAL OPTICAL LENS +1.5 (LEFT) FOR BIG EYES EVO/QUANTUM
DI335120	BIFOCAL OPTICAL LENS +2.0 (LEFT) FOR BIG EYES EVO/QUANTUM
DI335125	BIFOCAL OPTICAL LENS +2.5 (LEFT) FOR BIG EYES EVO/QUANTUM
DI335130	BIFOCAL OPTICAL LENS +3.0 (LEFT) FOR BIG EYES EVO/QUANTUM
DI336110	OPTICAL LENS - 1.0 (LEFT) FOR BIG EYES EVO/QUANTUM
DI336115	OPTICAL LENS - 1.5 (LEFT) FOR BIG EYES EVO/QUANTUM
DI336120	OPTICAL LENS - 2.0 (LEFT) FOR BIG EYES EVO/QUANTUM
DI336125	OPTICAL LENS - 2.5 (LEFT) FOR BIG EYES EVO/QUANTUM
DI336130	OPTICAL LENS - 3.0 (LEFT) FOR BIG EYES EVO/QUANTUM
DI336135	OPTICAL LENS - 3.5 (LEFT) FOR BIG EYES EVO/QUANTUM
DI336140	OPTICAL LENS - 4.0 (LEFT) FOR BIG EYES EVO/QUANTUM
DI336145	OPTICAL LENS - 4.5 (LEFT) FOR BIG EYES EVO/QUANTUM
DI336150	OPTICAL LENS - 5.0 (LEFT) FOR BIG EYES EVO/QUANTUM
DI336155	OPTICAL LENS - 5.5 (LEFT) FOR BIG EYES EVO/QUANTUM
DI336160	OPTICAL LENS - 6.0 (LEFT) FOR BIG EYES EVO/QUANTUM

## BIG EYES

PLEASE ALSO REFER TO THE **CRESSI SPARE PARTS CATALOG** FOR FURTHER INFORMATION AND TECHNICAL DETAILS.

CODE	PRODUCT
DI260010	OPTICAL LENS -1.0 (RIGHT) FOR BIG EYES
DI260015	OPTICAL LENS -1.5 (RIGHT) FOR BIG EYES
DI260020	OPTICAL LENS -2.0 (RIGHT) FOR BIG EYES
DI260025	OPTICAL LENS -2.5 (RIGHT) FOR BIG EYES
DI260030	OPTICAL LENS -3.0 (RIGHT) FOR BIG EYES
DI260035	OPTICAL LENS -3.5 (RIGHT) FOR BIG EYES
DI260040	OPTICAL LENS -4.0 (RIGHT) FOR BIG EYES
DI260045	OPTICAL LENS -4.5 (RIGHT) FOR BIG EYES
DI260050	OPTICAL LENS -5.0 (RIGHT) FOR BIG EYES
DI260055	OPTICAL LENS -5.5 (RIGHT) FOR BIG EYES
DI260060	OPTICAL LENS -6.0 (RIGHT) FOR BIG EYES
DI260110	OPTICAL LENS -1.0 (LEFT) FOR BIG EYES
DI260115	OPTICAL LENS -1.5 (LEFT) FOR BIG EYES
DI260120	OPTICAL LENS -2.0 (LEFT) FOR BIG EYES
DI260125	OPTICAL LENS -2.5 (LEFT) FOR BIG EYES
DI260130	OPTICAL LENS -3.0 (LEFT) FOR BIG EYES
DI260135	OPTICAL LENS -3.5 (LEFT) FOR BIG EYES
DI260140	OPTICAL LENS -4.0 (LEFT) FOR BIG EYES
DI260145	OPTICAL LENS -4.5 (LEFT) FOR BIG EYES
DI260150	OPTICAL LENS -5.0 (LEFT) FOR BIG EYES
DI260155	OPTICAL LENS -5.5 (LEFT) FOR BIG EYES
DI260160	OPTICAL LENS -6.0 (LEFT) FOR BIG EYES

PLEASE ALSO REFER TO THE **CRESSI SPARE PARTS CATALOG** FOR FURTHER INFORMATION AND TECHNICAL DETAILS

<b>FULLFACE MASK PARTS</b>	CODE	PRODUCT
	XDZ500001	DUKE DRY COMPLETE SNORKEL - CLEAR/GREY
	XDZ500002	DUKE DRY COMPLETE SNORKEL - BLACK/GREY
	XDZ500009	DUKE DRY MOUTHPIECE COVER - BLACK
	XDZ500010	DUKE DRY MOUTHPIECE COVER - GREY
	XDZ500011	DUKE DRY STRAP - BLACK-WHITE/SILVER
	XDZ500012	VALVES KIT FOR DUKE
	XDZ500300	BARON JR COMPLETE SNORKEL - CLEAR/CLEAR

<b>MASK PARTS</b>	CODE	PRODUCT
	DZ210005	BUCKLES - BLACK (PAIR) FOR ONDA/ONDINA/PERLA/PIUMETTA/SIRENA
	DZ210020	BUCKLES - BLACK FOR MAREA/MAREA JR/SKY/SKY JR/OCEAN
	DZ210040	SILICONE STRAP - CLEAR FOR SEA LINE MASKS
	DZ210042	SILICONE STRAP - BLACK FOR SEA LINE MASKS
	DZ221000	BUCKLES FOR SCUBA MASK TW - BLACK/CLEAR
	DZ221030	BUCKLES FOR SCUBA MASK TW - WHITE/CLEAR
	DZ221040	BUCKLES FOR SCUBA MASK TW - PINK/CLEAR
	DZ221050	BUCKLES FOR SCUBA MASK TW - BLACK/BLACK
	DZ222000	STRAP FOR SCUBA MASK TW - CLEAR
	DZ222030	STRAP FOR SCUBA MASK TW - WHITE
	DZ222040	STRAP FOR SCUBA MASK TW - PINK
	DZ222050	STRAP FOR SCUBA MASK TW - BLACK
	DZ215005	SILICONE STRAP - CLEAR FOR BIG EYES/FOCUS
	DZ215006	SILICONE STRAP - BLACK FOR BIG EYES/FOCUS
	DZ210008	BUCKLES - BLACK FOR BIG EYES
	DZ210010	BUCKLES - BLACK FOR FOCUS/SKY
	DZ215007	STRAP LOOP LARGE FOR FOCUS/BIG EYES - CLEAR (PAIR)
	DZ260030	STRAP + RETAINERS - WHITE FOR PEGASO
	DZ271030	BUCKLES - YELLOW/WHITE FOR PEGASO
	DZ272030	BUCKLES - BLUE/WHITE FOR PEGASO
DZ274130	BUCKLES - LILAC/WHITE FOR PEGASO	

<b>FINS PARTS</b>	CODE	PRODUCT
	BZ170003	FIN STRAP FOR PALAU FINS
	BZ170004	BUCKLES FOR PALAU FINS
	CZ242030	STRAP & BUCKLES ASSEMBLY - BLUE/WHITE FOR MINI BONETE/ROCKS
	CZ244130	STRAP & BUCKLES ASSEMBLY - LILAC/WHITE FOR BONETE/ROCKS
	USZ100020	STRAP & BUCKLES ASSEMBLY - BLACK/BLUE FOR BONETE
	USZ100041	STRAP & BUCKLES ASSEMBLY - BLACK/PURPLE FOR BONETE
USZ100050	STRAP & BUCKLES ASSEMBLY - BLACK/BLACK FOR BONETE	

<b>SWIM GOGGLES PARTS</b>	CODE	PRODUCT
	DZ300006	STRAP FOR MINIMA/GALILEO - CLEAR
	DZ300050	BUCKLES (BLACK) FOR SWIM GOGGLES
	DZ300060	BUCKLES (CLEAR) FOR SWIM GOGGLES
	DZ301020	SWIM GOGGLES SILICONE STRAP - BLUE
	DZ301030	SWIM GOGGLES SILICONE STRAP - WHITE
	DZ301040	SWIM GOGGLES SILICONE STRAP - PINK
	DZ301041	SWIM GOGGLES SILICONE STRAP - LILAC
	DZ301050	SWIM GOGGLES SILICONE STRAP - BLACK
	DZ301051	SWIM GOGGLES SILICONE STRAP - GREY
DZ301060	SWIM GOGGLES SILICONE STRAP - CLEAR	

<b>SPARE PARTS</b>	CODE	PRODUCT
	XKZ000001	MANTA BATTERY KIT W/O-RING (RENATA 371 - 36.0 X 0.8 MM)
KZ764788	WATCHSTRAP - RED FOR MANTA	



# SNORKEL PARTS

CODE	PRODUCT
EZ267004	SNORKEL KEEPER FOR AMERICA/TOP - BLACK
EZ267005	SNORKEL KEEPER FOR CORSICA/MEXICO/GAMMA - BLACK
EZ267009	SNORKEL KEEPER FOR CORSICA/MEXICO/GAMMA - CLEAR
EZ267011	SNORKEL KEEPER FOR TOP - CLEAR
EZ267015	SNORKEL KEEPER FOR ALPHA ULTRA DRY/BETA - GREY
EZ267018	SNORKEL KEEPER FOR SUPERNOVA DRY/TAO/TAO DRY - BLACK
EZ267018W	SNORKEL KEEPER FOR SUPERNOVA DRY/TAO/TAO DRY - WHITE
EZ270017	MOUTHPIECE FOR ALPHA ULTRA DRY/BETA - BLACK
EZ267019	SNORKEL KEEPER FOR MINIDRY - WHITE
EZ267019B	SNORKEL KEEPER FOR MINIDRY - BLACK
EZ269030	SNORKEL KEEPER - WHITE FOR IGUANA/IGUANA DRY
EZ270019	MOUTHPIECE FOR ALPHA ULTRA DRY/BETA - CLEAR
EZ270022	MOUTHPIECE FOR SUPERNOVA DRY/TAO/TAO DRY - BLACK
EZ270024	MOUTHPIECE FOR SUPERNOVA DRY/TAO/TAO DRY - CLEAR
EZ270026	MOUTHPIECE FOR MINI DRY - CLEAR
EZ270029	MOUTHPIECE FOR MEXICO/CORSICA - BLACK
EZ270031	MOUTHPIECE FOR MEXICO/CORSICA - CLEAR
EZ270036	MOUTHPIECE FOR TOP - CLEAR
EZ270039	MOUTHPIECE FOR TAO DRY - YELLOW
EZ270040	MOUTHPIECE FOR TAO DRY - BLUE
EZ270041	MOUTHPIECE FOR TAO DRY - PINK
EZ270044	MOUTHPIECE FOR TAO DRY - LILAC
EZ271020	MOUTHPIECE - CLEAR/BLUE FOR IGUANA/IGUANA DRY
EZ271041	MOUTHPIECE - CLEAR/LILAC FOR IGUANA/IGUANA DRY
US2631000	MOUTHPIECE - ISLAND SNORKEL

PLEASE ALSO REFER TO THE **CRESSI SPARE PARTS CATALOG** FOR FURTHER INFORMATION AND TECHNICAL DETAILS

## DIMENSION CHARTS

CRESSI'S SIZE CHART IS TO BE USED AS A REFERENCE ONLY

## BAGS DIMENSION CHART

	DIMENSION (LENGTH-WIDTH-HEIGHT)		VOLUME		WEIGHT	
	CENTIMETER	INCH	LITER	CU FT	KG	LB
<b>JUMBO</b>	50 x 35 x 80 h	19 3/4 x 13 3/4 x 31 1/2	140	4.90	4.5 kg	9 lb 15 oz
<b>MOBY 5</b>	40 x 28 x 76 h	15 1/2 x 11 x 30 h	115	4.06	3.9 kg	8 lb 10 oz
<b>MOBY 5 HYDRO</b>	40 x 28 x 76 h	15 1/2 x 11 x 30 h	115	4.06	5.1 kg	11 lb 4 oz
<b>GORILLA PRO XL</b>	95 x 34 x 42 h	37 x 13 x 16 h	135	4.77	1.5 kg	3 lb 5 oz
<b>TUNA</b>	95 x 40 x 41 h	37 1/2 x 15 3/4 x 16 1/8 h	120	4.23	3.5 kg	7 lb 11 oz
<b>GORGONA</b>	ø 38 x 96 h	ø 15 x 37 3/8 h	107	3.78	750 g	1 lb 10 oz
<b>ROATAN</b>	ø 39.5 - 72 h	15 ø - 28 h	90	3.18	1.2 kg	2 lb 10 oz
<b>UTILA</b>	ø 38.5 - 70 h	15 ø - 27 h	85	3.00	1.1 kg	2 lb 7 oz
<b>CRETE</b>	ø 37 x 60 h	ø 14 5/8 x 23 5/8 h	64.5	2.28	580 g	1 lb 4 oz
<b>PIPER</b>	35.5 x 23 x 56 h	14 x 9 x 22 h	49	1.73	2.9 kg	6 lb 6 oz
<b>DRY GARA BACK</b>	39.5 x 23.5 x 66 h	15 x 9 x 26 h	60	2.12	1.12 kg	2 lb 7.5 oz
<b>PIOVRA</b>	30 x 30 x 102 h	11 3/4 x 11 3/4 x 40 1/8 h	70	2.47	1.5 kg	3 lb 5 oz
<b>PIOVRA DRY</b>	30 x 30 x 130 h	11 3/4 x 11 3/4 x 44 h	85	3.00	1.6 kg	3 lb 8 oz
<b>OCTOPUS</b>	ø 23 x 54 h	ø 9 x 21 1/2 h	30	1.06	660 g	1 lb 7 oz
<b>DRY BAG 20 L</b>	ø 23 x 43 h	ø 9 x 17 h	20	0.71	480 g	16.9 oz
<b>DRY BAG 15 L</b>	ø 23 x 34 h	ø 9 x 13 1/2 h	15	0.53	350 g	12.3 oz
<b>DRY BAG 10 L</b>	ø 19 x 36 h	ø 7 1/2 x 14 1/8 h	10	0.35	320 g	11.3 oz
<b>DRY BAG 5 L</b>	ø 19 x 28 h	ø 7 1/2 x 11 h	5	0.18	255 g	9 oz

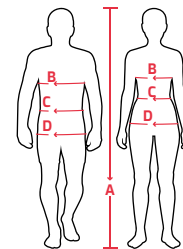

# DRYSUIT DIMENSION CHART



	Size	WEIGHT		(A) HEIGHT		(B) CHEST		(C) WAIST		(D) HIP		FOOT		
		kg	lbs	cm	in	cm	in	cm	in	cm	in	EU	UK	US
DRY SUIT MEN	S-II-48	60-68	132-150	164-170	65-67	78-83	31-33	65-71	25-28	78-83	31-33	40-42	7-8	7.5-8.5
	M-III-50	70-78	154-172	169-175	67-69	86-91	34-36	71-77	28-30	84-89	33-35	41-43	7.5-8.5	8-9
	L-IV-52	80-88	176-194	174-180	69-71	94-99	37-39	77-83	30-33	90-95	35-37	42-44	8-10	8.5-10.5
	XL-V-54	90-98	198-216	179-185	71-73	102-107	40-42	83-89	33-35	96-101	38-40	43-45	8.5-11	9-11.5
	XXL-VI-56	100-108	220-238	184-190	73-75	110-115	43-45	89-95	35-37	102-107	40-42	44-46	10-11.5	10.5-12
DRY SUIT WOMEN	XS-I-42	47-52	104-115	157-162	62-64	77-82	30-32	56-61	22-24	83-87	32-34	37-39	4.5-6.5	5-7
	S-II-44	53-58	117-128	162-167	64-66	82-87	32-34	60-65	24-26	87-91	34-36	38-40	5.5-7	6-7.5
	M-III-46	59-64	130-141	167-172	66-68	87-92	34-36	64-69	25-27	91-95	36-37	39-41	6.5-7.5	7-8
	L-IV-48	64-70	141-154	172-177	68-70	92-97	36-38	68-73	27-29	95-99	37-39	40-42	7-8	7.5-8.5
	XL-V-50	70-80	154-176	177-182	70-72	97-102	38-40	72-77	28-30	99-103	39-41	41-43	7.5-8.5	8-9



# MEN'S WETSUITS DIMENSION CHART

SIZE	WEIGHT		A - HEIGHT		B - CHEST		C - WAIST		D - HIP	
US/EU	kg	lb	cm	in	cm	in	cm	in	cm	in
XS: 36/46	50-58	110-128	156-165	5' 1" - 5' 5"	70-75	28-30	59-65	23-26	72-77	28-30
S: 38/48	60-68	132-150	164-173	5' 5" - 5' 8"	78-83	31-33	65-71	25-28	78-83	31-33
M: 40/50	70-78	154-172	169-178	5' 7" - 5' 10"	86-91	34-36	71-77	28-30	84-89	33-35
L: 42/52	80-88	176-194	174-183	5' 9" - 6' 0"	94-99	37-39	77-83	30-33	90-95	35/37
XL: 44/54	90-98	198-216	179-188	5' 10" - 6' 2"	102-107	40-42	83-89	33-35	96-101	38-40
2XL: 46/56	100-108	220-238	184-193	6' 0" - 6' 4"	110-115	43-45	89-95	35-37	102-107	40-42
3XL: 48/58	105-115	231-254	191-198	6' 3" - 6' 6"	118-123	46-48	95-101	37-40	108-113	43-45

# WOMEN'S WETSUITS DIMENSION CHART



SIZE	WEIGHT		A - HEIGHT		B - CHEST		C - WAIST		D - HIP	
US/EU	KG	LB	CM	IN	CM	IN	CM	IN	CM	IN
XS: 8/42	47-52	104-115	160-165	5' 3" - 5' 5"	77-82	30-32	56-61	22-24	83-87	32-34
S: 10/44	53-58	117-128	165-170	5' 5" - 5' 7"	82-87	32-34	60-65	24-26	87-91	34-36
M: 12/46	59-64	130-141	170-175	5' 7" - 5' 9"	87-92	34-36	64-69	25-27	91-95	36-37
L: 14/48	64-70	141-154	175-180	5' 9" - 5' 11"	92-97	36-38	68-73	27-29	95-99	37-39
XL: 16/50	70-80	154-176	180-185	5' 11" - 6' 1"	97-102	38-40	72-77	28-30	99-103	39-41
2XL: 18/52	80-90	176-198	185-190	6' 1" - 6' 3"	102-107	40-42	76-81	30-32	103-107	40.5-42

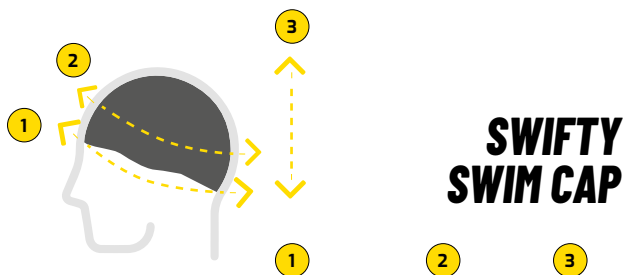

## SWIFTY SWIM CAP

SIZE	BASE CIRCUMFERENCE	LENGTH CIRCUMFERENCE	CAP HEIGHT
<b>S (SMALL)</b> IDEAL FOR KIDS	21.5 in 54 cm	26 in 66 cm	7 in 18 cm
<b>L (LARGE)</b> IDEAL FOR ADULTS	24.5 in 62 cm	28 in 71 cm	7.8 in 20 cm
<b>XL (X-LARGE)</b> IDEAL FOR LONG HAIR AND DREADLOCKS	27 in 68.5 cm	38 in 96.5 cm	11.4 in 29 cm

USA 12/2023

CRESSI'S SIZE CHART TO BE USED AS A REFERENCE ONLY

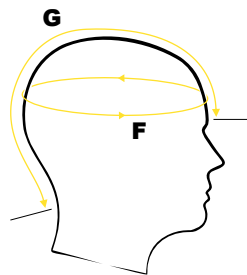

## HOODS

WOMEN'S SIZE CHART			MEN'S SIZE CHART		
SIZE	F HEAD CIRCUMFERENCE	G HEAD LENGTH	SIZE	F HEAD CIRCUMFERENCE	G HEAD LENGTH
XS	19.7 - 21.3 in (50-54 cm)	17.7 - 18.1 in (45-46 cm)	S	20.9 - 22 in (53-56 cm)	17.7 - 18.1 in (45-46 cm)
S/M	21.7 - 22.8 in (55-58 cm)	18.1 - 18.5 in (46-47 cm)	M/L	22 - 23.6 in (56-60 cm)	18.1 - 18.5 in (46-47 cm)
L/XL	23.2 - 24.4 in (59-62 cm)	18.5 - 18.9 in (47-48 cm)	XL 2XL 3XL	23.6 - 25.2 in (60-64 cm)	18.9 - 19.7 in (48-50 cm)

CRESSI'S SIZE CHART TO BE USED AS A REFERENCE ONLY

## GLOVES DIMENSION CHART

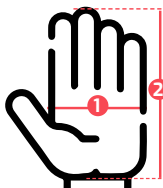

- 1 PALM CIRCUMFERENCE:** Measured at area shown (use soft measuring tape)
- 2 HAND LENGTH:** Measure from the wrist crease to the tip of the middle finger

CRESSI'S SIZE CHART TO BE USED AS A REFERENCE ONLY



## CONCH

SIZE CONVERSION CHART			
SIZE	1 PALM CIRCUMFERENCE	2 HAND LENGTH	3 TOTAL LENGTH
S	22.2 cm (8.7inch)	16 cm (6.2 inch)	26 cm (10.2 inch)
M	22.5 cm (8.9 inch)	17.2 cm (6.7 inch)	26.5 cm (10.4 inch)
L	23.1 cm (9.1 inch)	17.5 cm (6.8 inch)	27 cm (10.6 inch)
XL	24.3 cm (9.5 inch)	18 cm (7 inch)	28.4 cm (11.2 inch)
XXL	24.6 cm (9.6 inch)	19 cm (7.5 inch)	29.1 cm (11.5 inch)



## JUTLAND

SIZE CONVERSION CHART		
SIZE	1 PALM CIRCUMFERENCE	2 HAND LENGTH
S	19 cm - 20.3 cm (7.5 - 8 inch)	17.7 cm - 19 cm (7 -7.5 inch)
M	20.3 cm - 21.5 cm (8 - 8.5 inch)	19 cm - 20.5 cm (7.5 - 8 inch)
L	21.5 cm - 22.8 cm (8.5 - 9 inch)	20.5 cm - 21 cm (8 - 8.5 inch)
XL	24 cm - 26 cm (9.5 - 10.5 inch)	21.5 cm - 22.8 cm (8.5 - 9 inch)



## CRUZ

SIZE CONVERSION CHART		
SIZE	1 PALM CIRCUMFERENCE	2 HAND LENGTH
S	19 cm - 20.3 cm (7.5 - 8 inch)	17.7 cm - 19 cm (7 -7.5 inch)
M	20.3 cm - 21.5 cm (8 - 8.5 inch)	19 cm - 20.5 cm (7.5 - 8 inch)
L	21.5 cm - 22.8 cm (8.5 - 9 inch)	20.5 cm - 21 cm (8 - 8.5 inch)
XL	24 cm - 26 cm (9.5 - 10.5 inch)	21.5 cm - 22.8 cm (8.5 - 9 inch)



## HIGH STRETCH

SIZE CONVERSION CHART		
SIZE	1 PALM CIRCUMFERENCE	2 HAND LENGTH
S	19 cm - 20.3 cm (7.5 - 8 inch)	17.7 cm - 19 cm (7 -7.5 inch)
M	20.3 cm - 21.5 cm (8 - 8.5 inch)	19 cm - 20.5 cm (7.5 - 8 inch)
L	21.5 cm - 22.8 cm (8.5 - 9 inch)	20.5 cm - 21 cm (8 - 8.5 inch)
XL	24 cm - 26 cm (9.5 - 10.5 inch)	21.5 cm - 22.8 cm (8.5 - 9 inch)



## TROPICAL

SIZE CONVERSION CHART		
SIZE	1 PALM CIRCUMFERENCE	2 HAND LENGTH
S	19 cm - 20.3 cm (7.5 - 8 inch)	17.7 cm - 19 cm (7 -7.5 inch)
M	20.3 cm - 21.5 cm (8 - 8.5 inch)	19 cm - 20.5 cm (7.5 - 8 inch)
L	21.5 cm - 22.8 cm (8.5 - 9 inch)	20.5 cm - 21.5 cm (8 - 8.5 inch)
XL	22.9 cm - 24.1 cm (9 - 10.5 inch)	21.5 cm - 22.8 cm (8.5 - 9 inch)
XXL	24.1 cm - 25.4 cm (9.5 - 10 inch)	22.9 cm - 24.1 cm (9 - 9.5 inch)



## HUNTER GLOVES

SIZE CONVERSION CHART		
SIZE	1 PALM CIRCUMFERENCE	2 HAND LENGTH
S	19 cm - 20.3 cm (7.5 - 8 inch)	17.7 cm - 19 cm (7 -7.5 inch)
M	20.3 cm - 21.5 cm (8 - 8.5 inch)	19 cm - 20.5 cm (7.5 - 8 inch)
L	21.5 cm - 22.8 cm (8.5 - 9 inch)	20.5 cm - 21 cm (8 - 8.5 inch)
XL	24 cm - 26 cm (9.5 - 10.5 inch)	21.5 cm - 22.8 cm (8.5 - 9 inch)



## HEX

SIZE CONVERSION CHART			
SIZE	1 PALM CIRCUMFERENCE	2 HAND LENGTH	3 TOTAL LENGTH
XS	21 cm (8.2 inch)	15 cm (5.9 inch)	24 cm (9.4 inch)
S	22.2 cm (8.7 inch)	16 cm (6.2 inch)	26 cm (10.2 inch)
M	22.5 cm (8.9 inch)	17.2 cm (6.7 inch)	26.5 cm (10.4 inch)
L	23.1 cm (9.1 inch)	17.5 cm (6.8 inch)	27 cm (10.6 inch)
XL	24.3 cm (9.5 inch)	18 cm (7 inch)	28.4 cm (11.2 inch)
XXL	24.6 cm (9.6 inch)	19 cm (7.5 inch)	29.1 cm (11.5 inch)

# BOOTS DIMENSION CHART

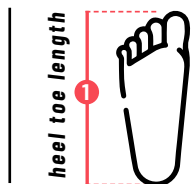

**TIP TO GET THE SHOE SIZE**  
Use a ruler to measure the heel to toe length and the chart to determine your shoe size.



**ISLA**

SIZE CONVERSION CHART				
1 HEEL TO TOE LENGTH	BOOT SIZE	EU SHOE SIZE	US SHOE SIZE	
			MEN	WOMEN
22.9 cm (9 inch)	5	36	5	6
23.7 cm (9 1/3 inch)	6	37	6	7
24.6 cm (9 2/3 inch)	7	38.5	7	8
25.4 cm (10 inch)	8	39.5	8	9
26.2 cm (10 1/3 inch)	9	41	9	10
27.1 cm (10 2/3 inch)	10	42	10	11
27.9 cm (11 inch)	11	43.5	11	12
28.8cm (11 1/3 inch)	12	44.5	12	13
29.6 cm (11 2/3 inch)	13	46	13	14
30.5 cm (12inch)	14	47	14	14+



**MINORCA**

SIZE CONVERSION CHART				
1 HEEL TO TOE LENGTH	BOOT SIZE	EU SHOE SIZE	US SHOE SIZE	
			MEN	WOMEN
22.9 cm (9 inch)	5	36	5	6
23.7 cm (9 1/3 inch)	6	37	6	7
24.6 cm (9 2/3 inch)	7	38.5	7	8
25.4 cm (10 inch)	8	39.5	8	9
26.2 cm (10 1/3 inch)	9	41	9	10
27.1 cm (10 2/3 inch)	10	42	10	11
27.9 cm (11 inch)	11	43.5	11	12
28.8cm (11 1/3 inch)	12	44.5	12	13
29.6 cm (11 2/3 inch)	13	46	13	14
30.5 cm (12inch)	14	47	14	14+



**IBIZA**

SIZE CONVERSION CHART				
1 HEEL TO TOE LENGTH	BOOT SIZE	EU SHOE SIZE	US SHOE SIZE	
			MEN	WOMEN
22.9 cm (9 inch)	5	36	5	6
23.7 cm (9 1/3 inch)	6	37	6	7
24.6 cm (9 2/3 inch)	7	38.5	7	8
25.4 cm (10 inch)	8	39.5	8	9
26.2 cm (10 1/3 inch)	9	41	9	10
27.1 cm (10 2/3 inch)	10	42	10	11
27.9 cm (11 inch)	11	43.5	11	12
28.8cm (11 1/3 inch)	12	44.5	12	13
29.6 cm (11 2/3 inch)	13	46	13	14
30.5 cm (12inch)	14	47	14	14+

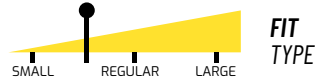

**BALEARI**

SIZE CONVERSION CHART			
1 HEEL TO TOE LENGTH	EU SHOE SIZE	US SHOE SIZE	
		MEN	WOMEN
23 cm (9 inch)	36 / 37	5	6
24cm (9.4 inch)	38 / 39	6.5	7.5
25 cm (9.8 inch)	39 / 40	7.5	8.5
26 cm (10.2 inch)	41 / 42	9	10
27cm (10.6 inch)	42 / 43	10	11
28 cm (11 inch)	44 / 45	11	12
29 cm (11.4 inch)	45 / 46	12	13
30 cm (11.8 inch)	47 / 48	13.5	14.5

**CRESSI'S SIZE CHART**  
TO BE USED AS A REFERENCE ONLY



# SOCKS DIMENSION CHART

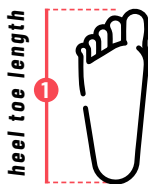

**TIP TO GET THE SHOE SIZE**  
Use a ruler to measure the heel to toe length and the chart to determine your shoe size.

## PALMA ST & LT



**FIT  
TYPE**

PRODUCT DIMENSION CHART			SIZE CONVERSION CHART		
SIZE	HEEL-TOE LENGTH CM	HEEL-TOE LENGTH IN	EU FOOT SIZE	US MEN'S FOOT SIZE	US WOMEN'S FOOT SIZE
XS/S	22.9 / 23.7	9 / 9 1/3	36	5 / 6	6 / 7
S/M	23.7 / 25.4	9 1/3 / 10	37	7 / 8	8 / 9
M/L	25.4 / 27.1	10 1/3 / 10 2/3	38.5	9 / 10	10 / 11
L/XL	27.1 / 28.8	11 / 11 1/3	39.5	11 / 12	12 / 13
XL/2XL	28.8 / 30.5	11 2/3 / 12	41	13	14

## CANARIE ST & LT



**FIT  
TYPE**

SIZE CONVERSION CHART			
SIZE	EU FOOT SIZE	US MEN'S FOOT SIZE	US WOMEN'S FOOT SIZE
S	36/38	5/6.5	6/7.5
M	39/40	7/8	8/9
L	41/43	9/10.5	10/11.5
XL	44/46	11/12.5	12/13.5
XXL	47/48	12.5<	14<



## ANTI-SLIP NEOPRENE SOCKS



**FIT  
TYPE**

SIZE CONVERSION CHART			
SIZE	EU FOOT SIZE	US MEN'S FOOT SIZE	US WOMEN'S FOOT SIZE
S	36 / 38	5 / 6.5	6 / 7.5
M	39 / 40	7 / 8	8 / 9
L	41 / 43	9 / 10.5	10 / 11.5
XL	44 / 46	11 / 12.5	12 / 13.5

\* Not available in size XL



Art Direction:  
**Jenifer Chavez**  
Editorial & Cover Design:  
**Alejandra Gómez**  
Lifestyle images  
by **Cressi Ambassadors**

© **Cressi Sub S.P.A.** All rights reserved.  
Reproduction, scanning, transmittal or storage,  
by any means of the images in this catalog, whole  
or in part, is prohibited without the prior written  
permission of Cressi Sub S.P.A.







# WE MANUFACTURE QUALITY SINCE 1946







#WE  
MANUFACTURE  
QUALITY  
SINCE 1946

 Cressi-sub USA, Inc.  
3 Rosal Lane  
Saddle Brook, NJ 07863

AMERICA  
CATALOG 2024  
VPBG0021



8 43037 51104 8